



Desde 1992 la marca FORCE es sinónimo de calidad y eficiencia en herramientas industriales y de automoción en los cinco continentes. Todos los productos FORCE se manufacturan con los más altos estándares de calidad como lo atestiguan las certificaciones ISO 9002 desde 1994 y la ISO 9001 desde 2003.

Esto es posible gracias a una constante evolución en calidad de manufactura, logística y servicio así como en innovación. En este último aspecto cabe destacar los sistemas de almacenamiento integrados FORCE Cabin I y FORCE Cabin II y sus múltiples opciones de personalización, que suponen una revolución en la organización de las herramientas en cualquier centro de trabajo así como una sustancial fuente de ahorro tanto en tiempo como en gasto directo.

Para fabricar las herramientas FORCE se seleccionan los mejores materiales, se aplica la más alta tecnología y se culmina con los más finos acabados y pulidos.

La búsqueda de nuevos mercados en los sectores de automoción, industria, energía o minería a lo largo de los años ha ido acompañada de un intenso esfuerzo innovador. Para responder a nuevas demandas y actividades es necesario aumentar la gama de productos y, como resultado, FORCE ofrece uno de los catálogos de herramientas más completos del mundo. Pero la innovación de FORCE no solamente se centra en novedades sino también en la mejora y renovación de los productos existentes.

Gracias a los elevados volúmenes de fabricación así como a la constante evolución en los procesos productivos, los productos FORCE tienen la mejor relación calidad/precio del mercado aportando así el máximo valor al usuario profesional.

Todas las ventajas en eficiencia y calidad de los productos FORCE están ahora disponibles en España y es nuestro objetivo principal ponerlos a disposición de todos los profesionales que buscan la mejor calidad a un precio asequible.

**Management system as per
ISO 9001 : 2008**

In accordance with TÜV NORD CERT procedures, it is hereby certified that

SHYANG YUN TOOLS CO., LTD.

**No. 161, Sitou Rd., Shengang Township,
Taichung County 42953, Taiwan, Republic of China**



applies a management system in line with the above standard for the following scope

**Design, Development and Manufacturing of Hand Tools,
Auto Tools and Pneumatic Tools**

Certificate Registration No. 44 100 072011

Audit Report No. 2.5-5869/2010

Valid until 2013-01-07

Initial Certification 2007-01-15

A handwritten signature in black ink, appearing to read "Richard", written over a faint circular watermark.

Certification Body
at TÜV NORD CERT GmbH

Hong Kong, 2010-01-08

This certification was conducted in accordance with the TÜV NORD CERT auditing and certification procedures and is subject to regular surveillance audits.

TÜV NORD CERT GmbH

Langemarckstrasse 20

45141 Essen

www.tuev-nord-cert.com



TGA-ZM-07-06-00



AGRADECIMIENTO A TAURO SPORT AUTO

Todo un orgullo para Force Tools que el fabricante español de referencia de superdeportivos haya confiado en la calidad de nuestros productos.

Una firma que, de la mano de Pedro J. Santos, aúna la más avanzada tecnología automotriz con los mejores acabados artesanales para hacer llegar a sus clientes un cúmulo sin igual de sensaciones y deportividad a través de modelos exclusivos, diseñados bajo los más altos estándares de calidad.

También agradecemos la cesión de las imágenes de los deportivos Tauro para la confección de este catálogo.

www.tauro.es



INDICE

Anything you need for tools...



Carros y cajas de herramientas

**Páginas
A-01~A-36**



Herramienta general

**Páginas
B-01~B-26**



Destornilladores y LLaves

**Páginas
C-01~C-26**



1/4"
Vasos, carracas, juegos y accesorios

**Páginas
D-01~D-12**



3/8"
Vasos, carracas, juegos y accesorios

**Páginas
E-01~E-06**



1/2"
Vasos, carracas, juegos y accesorios

**Páginas
F-01~F-23**



3/4"
Vasos, carracas, juegos y accesorios

**Páginas
G-01~G-02**



1"
Vasos, carracas, juegos y accesorios

**Páginas
H-01~H-02**



Herramienta neumática y de impacto

**Páginas
I-01~I-12**

J. Motor



Encendido

Páginas J-1 a J-2



Útiles para correas

Páginas J-31 a J-33



Sistemas de Inyección

Páginas J-43 a J-50



Circuito de combustible

Páginas J-65 a J-67



Aire acondicionado

Página J-69



Puesta a punto

Páginas J-2 a J-26



Útiles para mangueras

Páginas J-33 a J-37



Útiles para válvulas

Páginas J-50 a J-53



Sensor de oxígeno/Airbag

Páginas J-67 a J-68



Bloqueo de poleas

Páginas J-24 a J-31



Circuito de refrigeración

Páginas J-37 a J-38



Cilindros y pistones

Páginas J-53 a J-56



Juntas y muelles

Página J-68



Extracción de poleas

Páginas J-29 a J-31



Útiles de comprobación

Páginas J-38 a J-42



Cambio de aceite

Páginas J-56 a J-65



Soporte de motores

Página J-69

K. Circuito eléctrico



Extracción de terminales

Página K-1



Extracción de radios

Páginas K-1 a K-2



Útiles para baterías

Páginas K-2 a K-3



Testers

Páginas K-2 a K-6

L. Frenos / Transmisión



Útiles para frenos

Páginas L-1 a L-5



Extracción de rótulas

Páginas L-11 a L-13



Drenaje de fluidos

Páginas L-17 a L-18



Herramientas para ruedas

Páginas L-5 a L-8



Rótulas axiales

Páginas L-14 a L-15



Tubos de escape

Página L-18



Ejes y silent blocks

Páginas L-9 a L-10

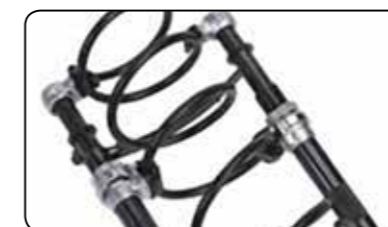

Amortiguadores

Páginas L-15 a L-16



Vaso para transmisiones

Página L-18



Extracción de ejes

Páginas L-10 a L-11



Palieres

Páginas L-16 a L-17

M. Camión



Herramienta de camión
Páginas M-1 a M-4

N. Carrocería



Desabolladores
Página N-1



Lijado de chapa
Página N-6



Útiles de chapista
Páginas N-1 a N2



Desmontaje de plásticos
Páginas N-7 a N-8



Soldaduras
Página N-4



Cambio de lunas
Páginas N-8 a N-10



Mordazas de tiro
Páginas N4 a N-5



Extractor de limpiaparabrisas
Página N-10

O. Motocicleta



Extracción de plato magnético
Página O-1



Válvulas y pistones
Página O-3



Horquilla y carburador
Páginas O-1 a O-2



Filtros de aceite
Página O-3



Cadena
Página O-2



Ejes
Página O-3

P. Extractores



EXTRACTORES
Páginas P-1 a P-6



■ **908G5** P. J-17
Juego de puesta a punto para VW, Audi



■ **928G1** P. J-18
Juego de puesta a punto para VW, Audi, Seat y Skoda



■ **929G1** P. J-19
Juego de puesta a punto para VW, Audi, Seat y Skoda

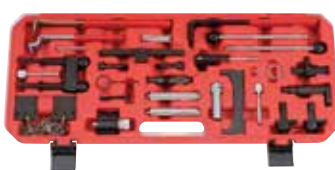

■ **904G15** P. J-19
Kit de bloqueo y ajuste de árbol de levas y cigüeñal para VW



■ **907G13** P. J-20
Juego de puesta a punto para VW / AUDI



■ **906G6** P. J-21
Juego de puesta a punto para VW



■ **904G16** P. J-21
Juego de puesta a punto para VW / AUDI



■ **914G5** P. J-21
Juego de puesta a punto para VW / AUDI



■ **908G13** P. J-19
Juego de puesta a punto para VW



■ **902G13** P. J-22
Útil para válvula central del árbol de levas VW / AUDI



■ **902G6** P. J-22
Kit para alinear árbol de levas en Audi V6



■ **9G1206** P. J-22
Juego de bloqueo de poleas del árbol de levas VW



■ **906G4** P. J-23
Juego de bloqueo de árbol de levas VAG TDI PD



■ **902G2** P. J-23
Juego de puesta a punto para VW, Audi



■ **9G0616** P. J-27
Llave de bloqueo del cigüeñal para VW / AUDI



■ **903G15** P. J-32
Juego para tensado de correas de alternador VAG



■ **902G4** P. J-32
Kit para tensar la correa de distribución VAG



■ **9G0704** P. J-28
Llave para poleas de bombas de agua



■ **34914010V** P. J-28
Vaso Ribe M10S para culatas



■ **904T5** P. J1
Juego de extractores de bobina de encendido VW, AUDI



■ **9G0208** P. J-35
Alicate para abrazaderas (para VW, AUDI 2.0)



■ **62530** P. J-34
Alicate para abrazaderas



■ **61925** P. J-64
Útil para drenar el filtro de aceite (VW)



■ **912G6** P. J-46
Extractor de inyectores VAG diesel y gasolina (TDI & FSI)





904G13 P. J-43

Juego de 4 vasos para inyectores diésel



44315022 P. J-67

Vaso extra largo de 1/2" para sonda lambda de 22mm



34805516T P. J-63

Vaso de 1/2" M16H para caja de cambios VAG corto



34810016T P. J-63

Vaso de 1/2" M16H para caja de cambios VAG largo



905G4 P. J-29

Extractor para polea del árbol de levas



34810009 P. J-54

Vaso XZN M9 de 1/2" x 100mm para culatas



34810010 P. J-54

Vaso XZN M10 de 1/2" x 100mm para culatas



34810012 P. J-54

Vaso XZN M12 de 1/2" x 100mm para culatas



34810014 P. J-54

Vaso XZN M14 de 1/2" x 100mm para culatas



907T6 P. L-9

Juego para reemplazar silent blocks VW



9T0205 P. L-18

Vaso para transmisiones automáticas VW



905T4 P. L-9

Juego de 5 Pzs. para suspensión trasera de VW, AUDI



904G18 P. J-16

Juego de puesta a punto para Mercedes-Benz M271



906G7 P. J-16

Juego de puesta a punto para Mercedes-Benz



674 P. J-30

Útil para alternadores XZN M10



678 P. J-30

Útil para alternadores T50



907G11 P. J-45

Juego de extracción de inyectores para Mercedes CDI



9G1803 / 9G1804 P. J-64

Varilla de nivel aceite de transmisión



9G1805 / 9G1806 P. J-65

Varilla de nivel de aceite



903G19 P. J-43

Juego para extracción de inyectores



903G17 P. J-45

Extractor de inyectores diésel para Mercedes CDI



909G5 P. J-45

Extractor de inyectores con maza de impacto para DB CDI



9G0121 P. J-46

Vaso de 33 dientes para bomba de inyección diésel MB



9G0122 P. J-47

Vaso para tuerca ranurada de pre-cámara diésel MB





TOYOTA



■ **907G3** P. J-45

Juego para termoventiladores viscosos MB y BMW



■ **34810009** P. J-54

Vaso XZN M9 de 1/2" x 100mm para culatas



■ **34810010** P. J-54

Vaso XZN M10 de 1/2" x 100mm para culatas



■ **34810012** P. J-54

Vaso XZN M12 de 1/2" x 100mm para culatas



■ **44315022** P. J-67

Vaso extra largo de 1/2" para sonda lambda de 22mm



■ **62820** P. L-14

Vaso dentado de 1/2" Mercedes (W163/W164)



■ **905T7** P. L-14

Juego de 5 vasos dentados de 1/2" para ejes MB



■ **34810014** P. J-54

Vaso XZN M14 de 1/2" x 100mm para culatas



■ **915G1** P. J-26

Juego de bloqueo de poleas TOYOTA



■ **34810009** P. J-54

Vaso XZN M9 de 1/2" x 100mm para culatas



■ **34810012** P. J-54

Vaso XZN M12 de 1/2" x 100mm para culatas



■ **905G1** P. J-11

Juego de puesta a punto para BMW (M52, M54, M56)



■ **907G6** P. J-11

Juego de puesta a punto para (BMW MINI)



■ **908G3** P. J-12

Juego de puesta a punto para BMW



■ **9G1207** P. J-12

Útil para poleas de BMW



■ **913G6** P. J-12

Juego de puesta a punto para BMW M41, M51, M47, M57



■ **905G17** P. J-13

Juego de puesta a punto para BMW M47



■ **904G11** P. J-14

Juego de puesta a punto para motores diésel BMW N47/N47S



■ **908G9** P. J-14

Juego de puesta a punto para BMW N42, N46, N46T



■ **918G3** P. J-15

Juego de puesta a punto para BMW N42/N46



■ **906G5** P. J-15

Juego de puesta a punto para BMW N40/N45/N45T



■ **912G5** P. J-15

Juego de puesta a punto para BMW N51/N52/N53/N54



■ **905G12** P. J-16

Juego de puesta a punto para BMW, Mini, Citroen, Peugeot





■ **674** P. J-30
Útil para alternadores XZN M10



■ **907G3** P. J-45
Juego para termoventiladores viscosos MB y BMW



■ **916G5** P. J-9
Juego de puesta a punto para FORD



■ **905G16** P. J-4
Juego para puesta a punto de OPEL diesel 1.9 CDTI



■ **9G0802** P. J-31
Tensor para bomba de agua Opel 41mm



■ **911G5** P. J-6
Juego de puesta a punto para diesel Opel / Renault / Nissan



■ **54615012B** P. J-54
Vaso de 1/2" Torx hembra E12 x DR. 150mm para culatas



■ **904G7** P. J-48
Extractor para bomba de inyección diésel (BMW)



■ **920G2** P. J-4
Juego para puesta a punto de Opel /Vauxhall



■ **9G0803** P. J-31
Tensor para bomba de agua Opel 46mm



■ **913G6** P. J-12
Juego de puesta a punto para BMW M41, M51, M47, M57



■ **908G11** P. J-44
Juego de extracción de inyectores diésel BMW



■ **9G1501** P. J-48
Extractor para bomba de inyección diésel (BMW)



■ **904G5** P. J-5
Juego para puesta a punto de GM / Opel 1.3 CDTI diésel



■ **44315022** P. J-67
Vaso extra largo de 1/2" para sonda lambda de 22mm



■ **9G0119** P. J-44
Juego de extracción de inyectores JTD



■ **44315022** P. J-67
Vaso extra largo de 1/2" para sonda lambda de 22mm



■ **34810014** P. J-54
Vaso XZN M14 de 1/2" x 100mm para culatas



■ **908G12** P. J-5
Juego de puesta a punto para RENAULT, NISSAN, OPEL diésel



■ **917G1** P. J-7
Juego de puesta a punto para Renault



■ **34810010** P. J-54
Vaso XZN M10 de 1/2" x 100mm para culatas





■ **34810012** P. J-54

Vaso XZN M12 de 1/2" x 100mm para culatas



■ **65014** P. L-4

Vaso pentagonal de 1/2" de 14mm para frenos



■ **44315022** P. J-67

Vaso extra largo de 1/2" para sonda lambda de 22mm



■ **917G1** P. J-7

Juego de puesta a punto para Renault



■ **916G5** P. J-9

Juego de puesta a punto para FORD



■ **904G6** P. J-10

Juego de puesta a punto para FORD



■ **912G10** P. J-26

Juego de puesta a punto para VOLVO

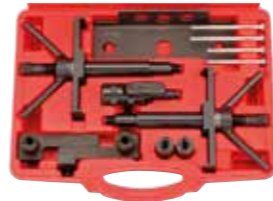

■ **9G0123** P. J-47

Vaso para el filtro de diesel (Motores HDi)



■ **905G8** P. J-8

Kit de bloqueo de poleas para FORD



■ **922G2** P. J-9

Juego de puesta a punto para Ford y Mazda



■ **911G6** P. J-9

Juego de puesta a punto para FORD



■ **916G5** P. J-9

Juego de puesta a punto para FORD



■ **9G1211** P. J-10

Juego de bloqueo de árbol de levas (Ford / Mazda)



■ **904G6** P. J-10

Juego de puesta a punto para FORD



■ **63302** P. J-66

Bomba manual para trasvase de combustible



■ **61927** P. J-59

Llave para filtro de aceite de 27mm



■ **44315022** P. J-67

Vaso extra largo de 1/2" para sonda lambda de 22mm



■ **910G7** P. J-24

Juego de puesta a punto para Fiat 1.2 8V & 1.4 16V



■ **9G0123** P. J-47

Vaso para el filtro de diesel (Motores HDi)





917G1 P. J-7

Juego de puesta a punto para Renault



903G5 P. J-8

Kit de bloqueo para Renault (Motores DCI)



922G2 P. J-9

Juego de puesta a punto para Ford y Mazda



935G1 P. J-23

Juego de puesta a punto para Peugeot, Citroën

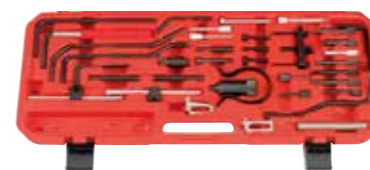

916G5 P. J-9

Juego de puesta a punto para FORD, PSA



905G16 P. J-4

Juego para puesta a punto de OPEL diesel 1.9 CDTI



908G12 P. J-5

Juego de puesta a punto para RENAULT, NISSAN, OPEL diésel



907G15 P. J-8

Kit de bloqueo de correa de distribución RENAULT 1.8 / 2.0 16V



916G5 P. J-9

Juego de puesta a punto para FORD, PSA



911G7 P. J-24

Juego de puesta a punto para Ford y PSA

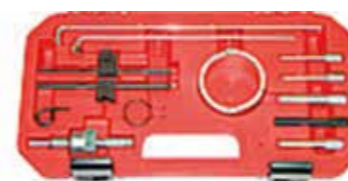

905G12 P. J-16

Juego de puesta a punto para BMW, Mini, Citroën, Peugeot



9G0119 P. J-44

Juego de extracción de inyectores JTD



911G5 P. J-6

Juego de puesta a punto para diesel Opel / Renault / Nissan



65019 P. L-4

Vaso pentagonal de 1/2" de 19mm para frenos



65019

904G6 P. J-10

Juego de puesta a punto para FORD



910G3 P. J-44

Juego para extracción de inyectores (PSA HDI/JTD)



9G0123 P. J-47

Vaso para el filtro de diesel (Motores HDi)



902G5 P. J-6

Kit de bloqueo de árbol de levas Renault



909G5 P. J-45

Extractor de inyectores con maza de impacto para DB CDI



904G13 P. J-43

Juego de 4 vasos para inyectores diésel



65019 P. L-4

Vaso pentagonal de 1/2" de 19mm para frenos





■ **934G1** P. J-25
Juego de puesta a punto para FIAT



■ **910G7** P. J-24
Juego de puesta a punto para Fiat 1.2 8V & 1.4 16V



■ **904G5** P. J-5
Juego para puesta a punto de GM / Opel 1.3 CDTI diésel



■ **9G0123** P. J-47
Vaso para el filtro de diesel (Motores HDi)



■ **9G0119** P. J-44
Juego de extracción de inyectores JTD



■ **348100095** P. J-54
Vaso XZN M9.5 de 1/2" x 100mm para culatas



■ **911G6** P. J-9
Juego de puesta a punto para FORD



■ **904G5** P. J-5
Juego para puesta a punto de GM / Opel 1.3 CDTI diésel



■ **911G5** P. J-6
Juego de puesta a punto para diésel Opel / Renault / Nissan



■ **916G5** P. J-9
Juego de puesta a punto para FORD



■ **910G3** P. J-44
Juego para extracción de inyectores (PSA HDI/JTD)



■ **911G5** P. J-6
Juego de puesta a punto para diésel Opel / Renault / Nissan



CARROS DE HERRAMIENTA.

CARACTERÍSTICAS GENERALES:



ACCESORIOS OPCIONALES:

10210R Aparador lateral



102105R Portarrollos



10217R-188 CARRO DE 7 CAJONES CON 188 HERRAMIENTAS

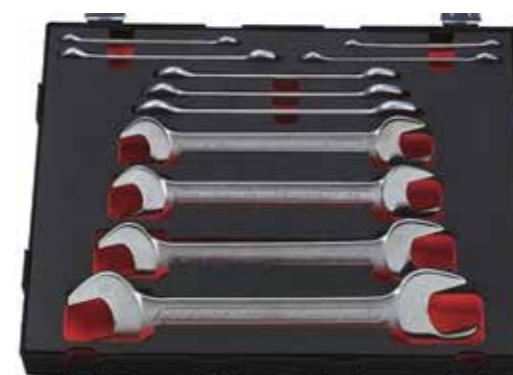
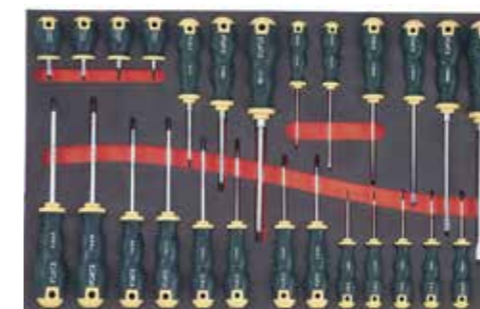

DETALLE DE LA DOTACIÓN DEL CARRO 10217R-188:

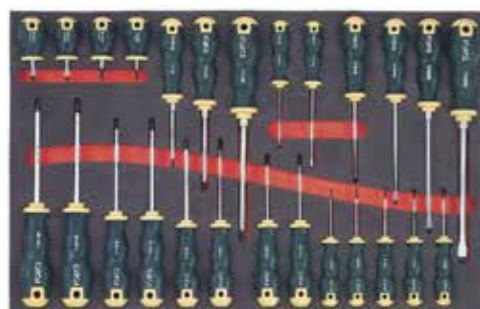
**Bandeja 2262 con 26 destornilladores:**

6 Planos de 3, 3.5, 4, 5.5, 6.5 y 8mm
 2 Planos cortos de 5.5 y 6.5mm
 3 Phillips PH1, PH2 y PH3
 2 Phillips cortos PH1 y PH2
 13 Torx T5, T6, T7, T8, T9, T10, T15, T20, T25, T27, T30, T40 y T45

**Bandeja 41083-72 con juego de vasos y carracas de 1/2" Y 1/4" con 108pzs.:**

12 Vasos de 1/4" cortos: 4, 4.5, 5, 5.5, 6, 7, 8, 9, 10, 11, 12 y 13mm
 8 Vasos de 1/4": 6, 7, 8, 9, 10, 11, 12 y 13mm
 6 Vasos torx hembra de 1/4": E4, E5, E6, E7, E8 y E10
 16 Vasos cortos de 1/2": 10, 11, 12, 13, 14, 15, 16, 17, 18, 19, 21, 22, 24, 27, 30 y 32mm
 5 Vasos largos de 1/2": 14, 15, 17, 19 y 22mm
 6 Vasos torx hembra de 1/2": E12, E14, E16, E18, E20 y E24
 3 Vasos de 1/4" con punta phillips: PH1, PH2 y PH3
 3 Vasos de 1/4" con punta pozidriv: PZ1, PZ2 y PZ3
 3 Vasos de 1/4" con punta plana: 4, 5.5 y 6.5mm
 6 Vasos de 1/4" con punta allen: 3, 4, 5, 6, 7 y 8mm
 8 Vasos de 1/4" con punta torx: T8, T10, T15, T20, T25, T27, T30 y T40
 8 Vasos de 1/4" con punta torx inviolable: T8H, T10H, T15H, T20H, T25H, T27H, T30H y T40H
 Juego de 11 llaves allen: 1.5, 2, 2.5, 3, 4, 5, 6, 7, 8, 10 y 12mm
 Carracas de 72 dientes de 1/4" y 1/2"
 Carraca mini T. Manerales corredizos de 1/4" Y 1/2"
 Extensiones de 1/4" de 50 y 100mm y de 1/2" DE 125 y 250mm
 Destornillador portavasos de 1/4", vaso magnético de 1/4" y articulaciones de 1/4" Y 1/2"

**Bandeja 51217 con 12 alicates y mordazas:**

610B200 Alicata de punta de 200mm.
 610B200B Alicata de punta curva de 200mm
 611B175 Alicata universal de 175mm. 614250 Mordaza grip de 250mm
 612B175 Alicata de corte diagonal reforzado de 175mm
 613B250 llave pico de loro de 250mm
 609ASO Alicata para anillos exterior recto de 19 a 60mm
 609ASC Alicata para anillos interior recto de 19 a 60mm
 609ABO Alicata para anillos exterior curvo de 19 a 60mm
 609ABC Alicata para anillos interior curvo de 19 a 60mm
 649250 Llave ajustable de 250mm.
 6982 Tijera de electricista inox bicomponente

**Bandeja 5182 con 18 martillos y cinceles:**

60212150Q Cincel con protección de 12x150mm
 60215180Q Cincel con protección de 15x180mm
 60219200Q Cincel con protección de 19x200mm
 60222200Q Cincel con protección de 22x200mm
 6042140Q Botador cilíndrico de 2x140mm
 6043150Q Botador cilíndrico de 3x150mm
 6044190Q Botador cilíndrico de 4x190mm
 6045200Q Botador cilíndrico de 5x200mm
 6046210Q Botador cilíndrico de 6x210mm
 6048215Q Botador cilíndrico de 8x215mm
 6065185Q Botador cónico de 5x185mm
 6076185Q Granete de 6x185mm
 616400 Mazo de goma de 400g.
 616300 Martillo de mecánico de 300g
 66303 Arco de sierra corto.
 5055P1 Tijera de chapa de 250mm
 5055P4 Cutter bicomponente con 2 hojas de 19mm

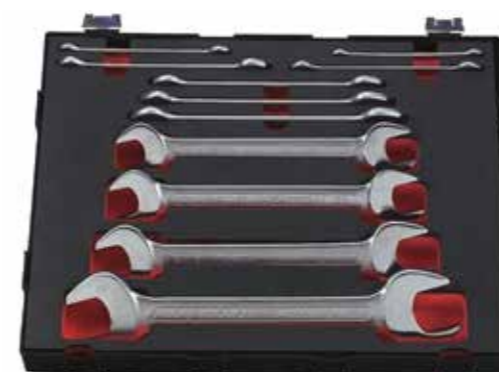
**K5128 Juego de 12 llaves fijas planas en estuche de espuma EVA:**

6x7, 8x9, 10x11, 12x13, 14x15, 16x17, 18x19, 20x22, 21x23, 24x26, 25x28 y 30x32

**51213 Juego de 12 llaves de estrella acodadas en estuche de espuma EVA:**

6x7, 8x9, 10x11, 12x13, 14x15, 16x17, 18,19, 20x22, 21x23, 24x26, 25x28 y 30x32.

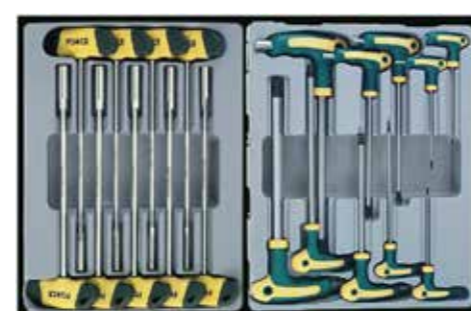
10217R-286 CARRO DE 7 CAJONES CON 286 HERRAMIENTAS

DETALLE DE LA DOTACIÓN DEL CARRO 10217R-286

**T2084B:**

6 Destornilladores bicomponente planos de 3x75, 3.5x100, 4x100, 5.5x125, 6.5x150 y 8x175.
2 Destornilladores phillips PH1x80 y PH2x100.

**T2085B:**

2 Destornilladores bicomponente planos de 5.5x25 y 6.5x25.
2 Destornilladores bicomponente phillips PH0x60 y PH1x25.
4 Destornilladores bicomponente pozidriv: PZ0x60, PZ1x25, PZ1x80 y PZ2x100.

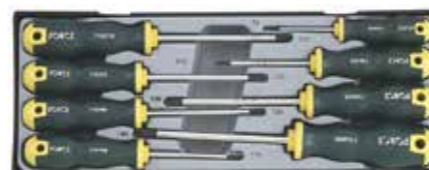
**T2086B:**

8 Destornilladores torx bicomponente: T8, T10, T15, T20, T25, T27, T30 y T40.

**T4413:**

Juego de vasos, puntas y llaves torx macho y hembra de 41pzs.:
Juego de 12 llaves torx: T10, T15, T20, T25, T27, T30, T40, T45, T50, T55, T60, T70.
9 Vasos de 1/4"x 32mm con punta torx: T8, T9, T10, T15, T20, T25, T27, T30 y T40.
2 Vasos de 3/8"x50mm con punta torx: T45 y T50.
3 Vasos de 1/2" con punta torx: T55x140mm, T60x100mm y T70x100mm.
6 Vasos torx hembra de 1/4": E4, E5, E6, E7, E8 y E10.
7 Vasos torx hembra de 3/8": E10, E11, E12, E14, E16, E18, E20.
2 Vasos torx hembra: E22 y E24.

**T2641:**

14 Vasos hexagonales de 1/4": 3.2, 4, 4.5, 5, 5.5, 6, 7, 8, 9, 10, 11, 12, 13 y 14mm.
9 Vasos hexagonales largos de 1/4": 5, 6, 7, 8, 9, 10, 11, 12 y 13mm.
7 Vasos de 1/4" con punta allen: 3, 4, 5, 6, 7, 8 y 10mm.
3 Vasos de 1/4" con punta phillips: PH1, PH2 y PH3.
3 Vasos de 1/4" con punta pozidriv: PZ1, PZ2 y PZ3.
3 Vasos de 1/4" con punta plana: 4, 5.5 y 6.5mm.
8 Vasos de 1/4" con punta torx: T8, T10, T15, T20, T25, T27, T30 y T40.
Carraca 802222 de 1/4" con 72 dientes.
Extensiones de 1/4" de 50, 100 y 150mm.
Maneral corredizo de 1/4", articulación de 1/4", destornillador portavasos de 1/4" y vaso magnético de 1/4".
Juego de llaves allen 5102XLB de 10 pzs. de 1.27, 1.5, 2, 2.5, 3, 4, 5, 6, 8 y 10mm.

**T3251-72-5:**

17 Vasos hexagonales de 3/8": 6, 7, 8, 9, 10, 11, 12, 13, 14, 15, 16, 17, 18, 19, 20, 21 y 22mm.
Carraca 802322 de 3/8" de 72 dientes
2 prolongadores de 3/8" de 75 y 150mm, articulación de 3/8" y maneral corredizo de 3/8".
2 Vasos de 3/8" para bujías de 16 y 20.6mm.

DETALLE DE LA DOTACIÓN DEL CARRO 10217R-286 (CONTINUACIÓN)



T4057:
Carraca de 1/2" 802422 de 72 dientes.
2 Extensiones de 1/2" de 125 y 250mm.
Maneral corredizo de 1/2" y articulación de 1/2".



T4212:
Juego de 21 vasos hexagonales de 1/2":
8, 10, 11, 12, 13, 14, 15, 16, 17, 18, 19, 20, 21, 22, 23, 24, 26, 27, 28, 30 y 32mm



T5052:
Juego de 5 Llaves combinadas de 26, 27, 28, 30 y 32mm.



T5082:
Juego de 8 llaves para racores de 8x10, 11x13, 12x14, 16x18, 17x19, 19x22, 24x27 y 30x32mm.



T5111:
Juego de 11 Llaves fijas planas de 6x7, 8x9, 10x11, 12x13, 14x15, 16x17, 18x19, 20x22, 21x23, 24x27 y 30x32mm.



T5161:
Juego de 16 Llaves combinadas de 6, 7, 8, 9, 10, 11, 12, 13, 14, 15, 16, 17, 18, 19, 22 y 24mm.



T5074:
Juego de 7 llaves de vaso articuladas de 6x7, 8x9, 10x11, 12x13, 14x15, 16x17 y 18x19mm.



T5033:
Juego de 3 llaves de vaso articuladas de 20x22, 21x23 y 24x27mm.



T5081:
Juego de 8 llaves de estrella acodadas de 6x7, 8x9, 10x11, 12x13, 14x15, 16x17, 18x19 y 21x23mm.



T5044:
Juego de 4 llaves de estrella acodadas de 23x26, 24x27, 25x28 y 30x32mm.



T5038:
1 Llave ajustable 649250B de 250mm con empuñadura de aluminio.
1 Llave de pico de loro 613B250 de 250mm.
1 Mordaza grip 614250 de 250mm.



T5046:
1 Alicata universal 611B175 de 175mm.
1 Alicata de punta 610B200 de 200mm.
1 Alicata de corte diagonal reforzado 612B175 de 175mm.
1 Alicata de junta variable 673B215 de 215mm.

DETALLE DE LA DOTACIÓN DEL CARRO 10217R-286 (CONTINUACIÓN)



T5053:
 1 Martillo de mecánico 616300 de 300g.
 1 Mazo de goma antirrebote 616400 de 400g.
 3 cinceles 60215180 de 15x180mm, 60219200 de 19x200mm y 60225220 de 22x220mm.

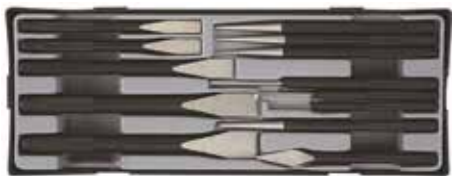

T5131:
 Juego de cinceles y botadores de 13pzs.:
 5 Cinceles: 60210150 de 10x150mm, 60212150 de 12x 150mm, 60215180 de 15x180mm, 60219200 de 19x200mm y 60222200 de 22x200mm.



2095:
 Juego de 9 llaves de tubo con mango T de 5, 6, 7, 8, 9, 10, 11, 12 y 13mm.

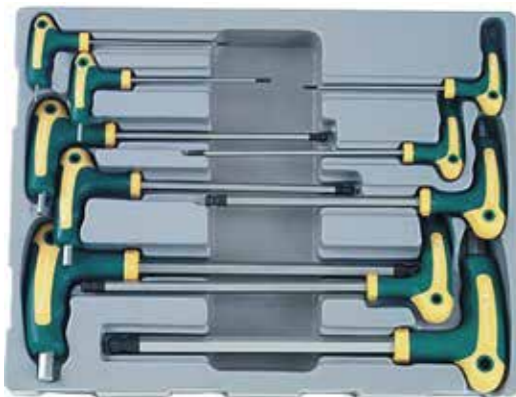

5106B:
 Juego de 10 llaves allen de doble punta y empuñadura bicomponente de 2, 2.5, 3, 4, 5, 6, 7, 8, 10 y 12mm.

DETALLE DE LA DOTACIÓN DEL CARRO 10217R-286

10318R-509 CARRO JUMBO DE 8 CAJONES CON 509 HERRAMIENTAS

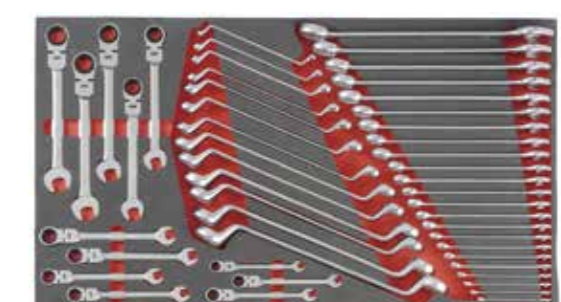
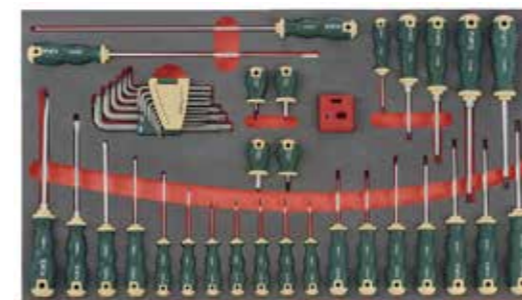

DETALLE DE LA DOTACIÓN DEL CARRO 10217R-286

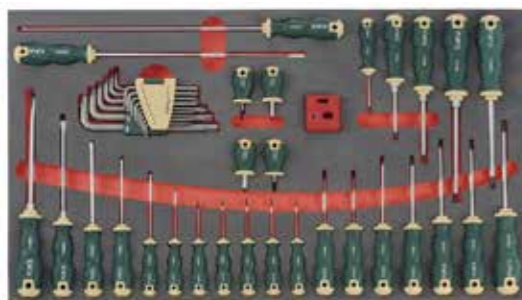
**Bandeja de espuma EVA 2452:**

2 Destornilladores cortos phillips: PH1 y PH2.
 5 Destornilladores phillips: PH0, PH1, PH2, PH3 y PH2x300mm.
 2 Destornilladores planos cortos: 5.5 y 6.5mm.
 7 Destornilladores planos: 3, 3.5, 4, 5.5, 6.5, 8 y 6x300mm.
 13 Destornilladores torx: T5, T6, T7, T8, T9, T10, T15, T20, T25, T27, T30, T40 y T45.
 Juego de 15 llaves torx inviolables: T6H, T7H, T8H, T9H, T10H, T15H, T20H, T25H, T27H, T30H, T40H, T45H, T50H, T55H y T60H.
 1 Imantador/desimantador.

**Bandeja de espuma EVA 41491:**

20 Vasos hexagonales de 1/2": 10, 11, 12, 13, 14, 15, 16, 17, 18, 19, 20, 21, 22, 23, 24, 26, 27, 28, 30 y 32mm.
 20 Vasos hexagonales largos de 1/2": 10, 11, 12, 13, 14, 15, 16, 17, 18, 19, 20, 21, 22, 23, 24, 26, 27, 28, 30 y 32mm.
 9 Vasos torx hembra de 1/2": E10, E11, E12, E4, E16, E18, E20, E22 y E24.
 8 Vasos torx hembra largos de 1/2": E10, E11, E12, E4, E16, E18, E20, y E24.
 7 Puntas de 10mm allen: 4, 5, 6, 7, 8, 10 y 12mm.
 7 Puntas de 10mm allen largas: 4, 5, 6, 7, 8, 10 y 12mm.
 9 Puntas de 10mm torx: T20, T25, T27, T30, T40, T45, T50, T55 y T60.
 9 Puntas de 10mm torx largas: T20, T25, T27, T30, T40, T45, T50, T55 y T60.
 4 Puntas de 10mm torx extra largas: T40, T45, T50 y T55.
 9 Puntas de 10mm torx inviolables: T20H, T25H, T27H, T30H, T40H, T45H, T50H, T55H y T60H.
 9 Puntas de 10mm torx inviolables largas: T20H, T25H, T27H, T30H, T40H, T45H, T50H, T55H y T60H.
 5 Puntas de 10mm XZN: M5, M6, M8, M10 y M12.
 5 Puntas de 10mm XZN largas: M5, M6, M8, M10 y M12.
 3 Puntas de 10mm XZN extra largas: M8, M10 y M12.
 9 Puntas de 10mm Ribe: M4, M5, M6, M8, M9, M10, M12, M13 y M14.
 9 Puntas de 10mm Ribe largas: M4, M5, M6, M8, M9, M10, M12, M13 y M14.
 Carraca de 1/2" de 36 dientes, articulación de 1/2", extensiones de 1/2" de 75, 125 y 250mm, maneral corredizo de 1/2" y vaso portapuntas de 1/2".

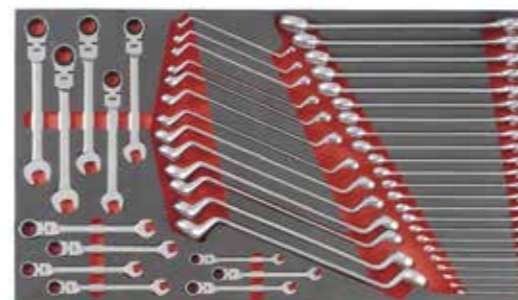
**Bandeja de espuma EVA 5481:**

Juego de 23 llaves combinadas: 6, 7, 8, 9, 10, 11, 12, 13, 14, 15, 16, 17, 18, 19, 21, 22, 23, 24, 26, 27, 28, 30 y 32mm.
 Juego de 13 llaves de estrella acodadas: 6x7, 8x9, 10x11, 12x13, 14x15, 16x17, 18x19, 20x22, 21x23, 23x26, 24x27, 25x28 y 30x32mm.
 Juego de 12 llaves combinadas articuladas con carraca: 8, 9, 10, 11, 12, 13, 14, 15, 16, 17, 18 y 19mm.

**Bandeja de espuma EVA 21251:**

13 Vasos hexagonales de 1/4": 3.2, 4, 4.5, 5, 5.5, 6, 7, 8, 9, 10, 11, 12 y 13mm.
 12 Vasos hexagonales largos de 1/4": 4, 4.5, 5, 5.5, 6, 7, 8, 9, 10, 11, 12 y 13mm.
 6 Vasos torx hembra de 1/4": E4, E5, E6, E7, E8 y E10.
 6 Vasos torx hembra largos de 1/4": E4, E5, E6, E7, E8 y E10.
 4 Vasos de 1/4" con punta phillips: PH0, PH1, PH2 y PH3.
 4 Vasos de 1/4" con punta pozidriv: P20, P21, P22 y P23.
 3 Vasos de 1/4" con punta plana: 4, 5.5 y 6.5mm.
 7 Vasos de 1/4" con punta allen: 3, 4, 5, 6, 7, 8 y 10mm.
 8 Vasos de 1/4" con punta torx: T8, T10, T15, T20, T25, T27, T30 y T40.
 8 Vasos de 1/4" con punta torx inviolable: T8H, T10H, T15H, T20H, T25H, T27H, T30H y T40H.
 7 Vasos de 1/4" con punta torx 5 puntas: TS10, TS15, TS20, TS25, TS27, TS30 y TS40.
 Juego de llaves allen largas: 1.5, 2, 2.5, 3, 4, 5, 6, 7, 8, 10 y 12mm.
 Carraca de 1/4" de 20 dientes, carraca articulada de 1/4" de 72 dientes y carraca mini T.
 Maneral corredizo de 1/4", extensiones de 1/4" de 50, 100, 150 y 250mm y articulación de 1/4".
 Vaso magnético de 1/4", destornillador portavasos de 1/4" y extensión flexible de 1/4".
 Destornillador dinamométrico de 1/4" y llave dinamométrica de 1/4" de 6-30Nm.
 4 Alicates de electrónica de 125mm: punta redonda, punta plana, universal y punta larga.
 4 Alicates de electrónica de 150mm: punta de aguja, punta curva, corte frontal y corte diagonal.
 2 destornilladores de precisión phillips: PH000 y PH00.
 3 destornilladores de precisión planos de: 1.0, 1.2, 1.5, 1.8, 2.0 y 2.5mm.
 2 destornilladores de precisión allen: 0.9, 1.3 y 1.5mm.
 Pinzas, tijeras y cuchilla escalpelo con 6 hojas.

DETALLE DE LA DOTACIÓN DEL CARRO 10318R-509 (CONTINUACIÓN)

**Bandeja de espuma EVA 5173:**

610B200 Alicata de punta de 200mm.
 610B200B Alicata de punta curva de 200mm.
 611B175 Alicata universal de 175mm.
 612B175 Alicata de corte diagonal reforzado de 175mm.
 614250 Mordaza grip de 250mm.
 613B250 llave pico de loro de 250mm.
 609ASO Alicata para anillos exterior recto de 19 a 60mm.
 609ASC Alicata para anillos interior recto de 19 a 60mm.
 609ABO Alicata para anillos exterior curvo de 19 a 60mm.
 609ABC Alicata para anillos interior curvo de 19 a 60mm.
 649250 Llave ajustable de 250mm.
 Alicata de junta deslizante de 215mm.
 Cortacables para cobre y aluminio de 250mm.
 Alicata de pelado y corte HD. Mordaza grip de boga S.
 Alicata de corte para plástico de 160mm. Alicata de electricista 4 en 1.

**Bandeja de espuma EVA 5242:**

60210150Q Cincel con protección de 10x150mm.
 60212150Q Cincel con protección de 12x150mm.
 60215180Q Cincel con protección de 15x180mm.
 60219200Q Cincel con protección de 19x200mm.
 60222200Q Cincel con protección de 22x200mm.
 60225220Q Cincel con protección de 25x220mm.
 6042140Q Botador cilíndrico de 2x140mm.
 6043150Q Botador cilíndrico de 3x150mm.
 6044190Q Botador cilíndrico de 4x190mm.
 6045200Q Botador cilíndrico de 5x200mm.
 6046210Q Botador cilíndrico de 6x210mm.
 6048215Q Botador cilíndrico de 8x215mm.
 6064185Q Botador cónico de 4x185mm.
 6065185Q Botador cónico de 5x185mm.
 6066185Q Botador cónico de 6x185mm.
 6074185Q Granete de 4x185mm.
 616400 Mazo de goma de 400g.
 616300 Martillo de mecánico de 300g.
 66303 Arco de sierra corto.
 5055P1 Tijera de chapa de 250mm.
 5055P4 Cutter bicomponente con 2 hojas de 19mm.
 Flexómetro de 5m y tijera de electricista.

**Bandeja de espuma EVA 5521:**

Juego de 10 llaves para racores: 8x10, 9x11, 11x13, 12x14, 14x17, 16x18, 17x19, 19x22, 24x27 y 30x32mm.
 5 Limas de 8": plana, media caña, cuadrada, redonda y triangular.
 1 Destorgolpe con 2 puntas phillips PH2 y PH2, 2 puntas planas 9 y 11mm, 3 puntas allen 6, 8 y 10mm, 5 puntas torx T25, T30, T40, T45 y T50.
 Adaptador para puntas de 5/16"x3/8" y portapuntas de golpe de 1/2"x5/16".
 4 Vasos extractores de espárragos de: 6, 8, 10 y 12mm.
 3 rompetuercas de: 9-12mm, 12-16mm y 16-22mm.
 Juego de 5 machos extractores de espárragos: 7/64", 9/64", 5/32", 1/4" y 19/64".
 Calibre, regla de 30cm y transportador de ángulos de acero inoxidable.
 Granete autocentrante.
 Galgas de roscas de 0.25 a 6mm y SAE de 4 a 62.
 Punta de trazar, juego de 26 galgas de espesores, lámpara LED magnética y flexible y dedo magnético 3 en 1.

**Bandeja de espuma EVA 4491:**

20 Vasos de impacto de 1/2": 10, 11, 12, 13, 14, 15, 16, 17, 18, 19, 20, 21, 22, 23, 24, 26, 27, 28, 30 y 32mm.
 20 Vasos de impacto largos de 1/2": 10, 11, 12, 13, 14, 15, 16, 17, 18, 19, 20, 21, 22, 23, 24, 26, 27, 28, 30 y 32mm.
 3 Vasos coloreados para llantas de aluminio: 17, 19 y 21mm.
 Articulación de impacto de 1/2".
 Extensión de impacto de 1/2" de 125mm.
 Tenaza para equilibrar ruedas.
 Llave de rueda desmontable de: 17, 19, 13/16" vaso hexagonal y 1/2" cuadrado conductor.
 Llave de impacto 82549 de composite 1054Nm.
 Llave dinamométrica de 1/2" de 40 a 200Nm.

1013R-562 CARRO DE 13 CAJONES CON 562 HERRAMIENTAS



DETALLE DE LA DOTACIÓN DEL CARRO 1013R-562



T5038:
 1 Llave ajustable 649250B de 250mm con empuñadura de aluminio.
 1 Llave de pico de loro 613B250 de 250mm.
 1 Mordaza grip 614250 de 250mm.



5046:
 1 Alicata universal 611B175 de 175mm.
 1 Alicata de punta 610B200 de 200mm.
 1 Alicata de corte diagonal reforzado 612B175 de 175mm.
 1 Alicata de junta variable 673B215 de 215mm.



T5053:
 1 Martillo de mecánico 616300 de 300g.
 1 Mazo de goma antirrebote 616400 de 400g.
 3 cinceles 60215180 de 15x180mm, 60219200 de 19x200mm y 60225220 de 22x220mm



T5055:
 5055P1 Tijera de chapa recta.
 66302 Arco de sierra mini 6".
 5055P4 Cutter bicomponente con 2 hojas de repuesto de 19mm.



T5082:
 Juego de 8 llaves para racores de 8x10, 11x13, 12x14, 16x18, 17x19, 19x22, 24x27 y 30x32mm



T5111:
 Juego de 11 llaves fijas planas de 6x7, 8x9, 10x11, 12x13, 14x15, 16x17, 18x19, 20x22, 21x23, 24x27 y 30x32mm



T5172:
 Juego de llaves de pata de cuervo de 3/8" y 1/2" de 17pzs:
 12 llaves de pata de cuervo de 3/8": 10, 11, 12, 13, 14, 15, 16, 17, 18, 19, 21 y 22mm.
 2 llaves de pata de cuervo de 1/2": 23, 24 y 26mm.
 Extensión de 3/8" de 150mm y de 1/2" de 125mm.

DETALLE DE LA DOTACIÓN DEL CARRO 1013R-562 (CONTINUACION)



T5331:
Mango de destorgolpe. 3 Rompetuercas de 9-12, 12-16 y 16-22mm.
14 Puntas de 5/16"x36mm: PH2, PH3, PZ2, PZ3, 2 planas de 9 y 11mm, 3 allen de 6, 8 y 10mm y 5 torx T25, T30, T40, T45, T50. 4 Puntas de 5/16" de 80mm: PH2, PH30, planas de 9 y 11mm.
Adaptador para puntas de 3/8"x5/16"y portapuntas de 1/2"x5/16". 4 Vasos extractores de espárragos de 6, 8, 10 y 12mm. Juego de 5 machos extractores de espárragos de 7-64", 9/64", 5/32", 1/4", 19/64".



T4119:
Juego de 11 vasos de impacto de 1/2" largos: 12, 14, 17, 19, 21, 22, 23, 24, 27, 30 y 32mm.



T4193:
Juego de 19 vasos de impacto de 1/2" : 10, 11, 12, 13, 14, 15, 16, 17, 18, 19, 21, 22, 23, 24, 26, 27, 30 y 32mm y extensión de impacto de 1/2" de 125mm.



T4413:
Juego de vasos, puntas y llaves torx macho y hembra de 41pzs.:
Juego de 12 llaves torx: T10, T15, T20, T25, T27, T30, T40, T45, T50, T55, T60, T70.
9 Vasos de 1/4"x 32mm con punta torx: T8, T9, T10, T15, T20, T25, T27, T30 y T40.
2 Vasos de 3/8"x50mm con punta torx: T45 y T50
3 Vasos de 1/2" con punta torx: T55x140mm, T60x100mm y T70x100mm. 6 Vasos torx hembra de 1/4": E4, E5, E6, E7, E8 y E10.
7 Vasos torx hembra de 3/8": E10, E11, E12, E14, E16, E18, E20. 2 Vasos torx hembra: E22 y E24



T5122:
6 Llaves para tapones de cárter: 5/16"Hex.-3/8"Hex., 8mm cuad.-3/8" cuad., 11mm cuad.-12mm hex., 13mm cuad.-14hex., 17mm hex.-1/2" hex., 8mm hex.-10mm hex.
2 Vasos magnéticos para bujías de 1/2" de 16 y 20.6mm.
Vaso para llaves de tapón de cárter de 1/2"Mx21mmH.
Espejo retráctil con imán, juego de galgas de espesores de 20pzs de 0.05 a 1mm y Llave para filtro de aceite.

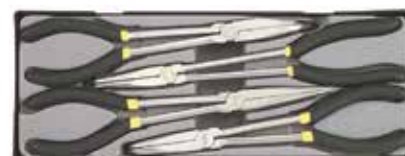

T5047:
Juego de 4 alicates de punta extra largos de 11":
5047P1 de punta recta,
5047P2 de punta curva a 45º
5047P3 de punta curva a 90º
5047P4 para capuchones.



T5057:
Juego de 5 mordazas grip multiusos:
67901 de doble boca plana ancha
67902 de doble mandíbula curva
67903 de boca ancha curva
67904 de boca oblicua
67905 de boca recta.



T5057:
Juego de 5 mordazas grip multiusos:
67901 de doble boca plana ancha
67902 de doble mandíbula curva
67903 de boca ancha curva
67904 de boca oblicua
67905 de boca recta.

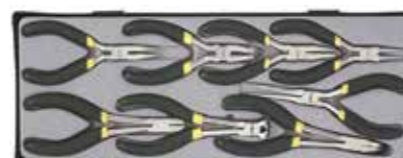

T50814:
Juego de 8 alicates de precisión:
4 Alicates de 125mm, punta redonda, punta plana, universal y punta larga.
4 Alicates de 150mm de punta de aguja, punta curva, corte frontal y corte diagonal.



T51811:
Remachadora 67801 de cabezal giratorio con surtido de remaches.



5048:
Juego de 3 prensaterminales y pelacables:
6801 Prensaterminales para terminales rojos, azules y amarillos.
6802 Prensaterminales para terminales de 0.5, 0.75, 1.0, 1.5, 2.5 y 4mm.
6803 Prensaterminales para terminales de 0.5-1, 1.1-2.5 y 4-6mm.
6804 Pelacables.



54111:
Pistola para poner bridas de nylon con surtido de bridas.

DETALLE DE LA DOTACIÓN DEL CARRO 1013R-562 (CONTINUACION)



2137:
Juego de 13 destornilladores torx: T5, T6, T7, T8, T9, T10, T15, T20, T25, T27, T30, T40 y T45.



2142:
Juego de 14 alicates bicomponente:
8 Planos de 3x75, 3.5x100, 4x100, 5.5x125, 6.5x150, 8x175, 5.5x25 y 6.5x25mm.
6 Phillips de PH0x60, PH1x80, PH2x100, PH3x150, PH1x25 y PH2x25mm.



T2046:
Llave de carraca de 1/4" 80222 de 24 dientes, llave de carraca corta 802219 de 1/4" de 20 dientes, llave de carraca articulada de 1/4" 802223 de 72 dientes.
6472300W Llave dinamoétrica de 1/4" de 6 a 30Nm.



T2742:
Juego de vasos de 1/4" de 74pzs.:
12 Vasos hexagonales de 1/4": 4, 4.5, 5, 5.5, 6, 7, 8, 9, 10, 11, 12 y 13mm.
12 Vasos hexagonales largos de 1/4": 4, 4.5, 5, 5.5, 6, 7, 8, 9, 10, 11, 12 y 13mm.
6 Vasos torx hembra de 1/4": E4, E5, E6, E7, E8 y E10.
6 Vasos torx hembra largos de 1/4": E4, E5, E6, E7, E8 y E10.
32 Puntas de 32mm:
7 allen de 3, 4, 5, 6, 7, 8 y 10mm, 3 phillips PH0, PH1 y PH2, 3 pozidriv PZ0, PZ1 y PZ2, 3 planas de 4, 5.5 y 6.5mm, 8 torx T8, T10, T15, T20, T25, T27, T30 y T40 y 8 torx inviolables T8H, T10H, T15H, T20H, T25H, T27H, T30H y T40H.
Carraca corta de 1/4" 802220 de 72 dientes.
Extensiones de 1/4" de 50, 100 y 150mm, articulación de 1/4" y vaso magnético de 1/4".



T5161:
Juego de 16 Llaves combinadas de 6, 7, 8, 9, 10, 11, 12, 13, 14, 15, 16, 17, 18, 19, 22 y 24mm.



T5052:
Juego de 5 Llaves combinadas de 26, 27, 28, 30 y 32mm.



T3311:
Juego de vasos y accesorios de 3/8" de 31pzs.:
7 Vasos hexagonales de 3/8": 6, 7, 8, 9, 10, 11 y 12mm.
7 Vasos hexagonales largos de 3/8": 6, 7, 8, 9, 10, 11 y 12mm.
10 Vasos de 3/8" con punta allen: 3, 4, 5, 5.5, 6, 7, 8, 9, 10 y 12mm.
Maneral articulado de 3/8", 4 extensiones de 3/8" de 45, 75, 150 y 250mm, articulación de 3/8" y adaptador de 3/8"Hx3/8"M para maneral.



T3331:
Juego de vasos de 3/8" de 33pzs.:
11 Vasos hexagonales de 3/8": 13, 14, 15, 16, 17, 18, 19, 20, 21 y 22mm.
10 Vasos hexagonales largos de 3/8": 13, 14, 15, 16, 17, 18, 19, 20, 21, 22 y 24mm.
12 Vasos de 3/8" con punta torx: T8, T10, T15, T20, T25, T27, T30, T40, T45, T50, T55 y T60.



T3381:
Juego de vasos de 3/8" torx y XZN de 38 pzs.:
10 Vasos de 3/8" torx hembra: E4, E5, E6, E7, E8, E10, E11, E12, E14 y E16.
10 Vasos de 3/8" torx hembra largos: E4, E5, E6, E7, E8, E10, E11, E12, E14 y E16.
12 Vasos de 3/8" con punta torx inviolable: T8H, T10H, T15H, T20H, T25H, T27H, T30H, T40H, T45H, T50H, T55H y T60H.
6 Vasos de 3/8" con punta XZN: M5, M6, M8, M9, M10 y M12.



T30712:
6473365 Llave dinamoétrica de 3/8" de 19 a 110Nm.
Carraca articulada de 3/8" 802323 de 72 dientes, carraca de 3/8" 80232 de 24 dientes y carraca corta de 3/8" 802319 de 30 dientes.
3 Vasos para bujías de 3/8" de 16, 18 y 20.6mm.

DETALLE DE LA DOTACIÓN DEL CARRO 1013R-562 (CONTINUACION)



T4203:
Juego de vasos hexagonales de 1/2" de 20pzs.:
10 Vasos hexagonales de 1/2": 20, 21, 22, 23, 24, 26, 27, 28, 30 y 32mm.
10 Vasos hexagonales largos de 1/2": 20, 21, 22, 23, 24, 26, 27, 28, 30 y 32mm.



T4248:
Juego de vasos hexagonales de 1/2" de 24pzs.:
12 Vasos hexagonales de 1/2": 8, 9, 10, 11, 12, 13, 14, 15, 16, 17, 18 y 19mm.
12 Vasos hexagonales largos de 1/2": 8, 9, 10, 11, 12, 13, 14, 15, 16, 17, 18 y 19mm.



T4322:
Juego de vasos de 1/2" torx y XZN de 32 pzs.:
8 Vasos de 1/2" torx hembra: E10, E11, E12, E14, E16, E18, E20 y E24.
8 Vasos de 1/2" torx hembra largos: E10, E11, E12, E14, E16, E18, E20 y E24.
4 Vasos de 1/2" con punta torx: T50, T55, T60 y T70.
4 Vasos de 1/2" con punta torx inviolable: T50H, T55H, T60H y T70H.
8 Vasos de 1/2" con punta XZN: M5, M6, M8, M9, M10, M12, M14 y M16.



T40612:
Juego de 6 accesorios de 1/2": Carraca de 1/2" 802415 de 36 dientes.
2 Extensiones de 1/2" de 125 y 250mm, maneral corredizo de 1/2", articulación de 1/2" y maneral basculante de 1/2".



T5074:
Juego de 7 llaves de vaso articuladas de 6x7, 8x9, 10x11, 12x13, 14x15, 16x17 y 18x19mm.



T5033:
Juego de 3 llaves de vaso articuladas de 20x22, 21x23 y 24x27mm.



T5081:
Juego de 8 llaves de estrella acodadas de 6x7, 8x9, 10x11, 12x13, 14x15, 16x17, 18x19 y 21x23mm.



T5044:
Juego de 4 llaves de estrella acodadas de 23x26, 24x27, 25x28 y 30x32mm.



T5056:
Juego de 5 limas de 8": plana, media caña, redonda, cuadrada y triangular.



T5096:
Juego de herramientas de medición de 9 pzs.:
Calibre, granete autocentrante, regla de 30cm, transportador de ángulos, galgas de roscas métrica y SAE, galga de espesores, puta de trazar y flexómetro.



T5131:
Juego de cinceles y botadores de 13pzs.:
5 Cinceles:
60210150 de 10x150mm
60212150 de 12x 150mm
60215180 de 15x180mm
60219200 de 19x200mm
60222200 de 22x200mm.



T5043A:
Juego de 4 alicates para anillos interiores y exteriores rectos y curvos de 19 a 60mm.

50233-48 CAJA DE 2 ALTURAS CON 48 HERRAMIENTAS

50233



C5166



C2206



C51221

DETALLE DE LA DOTACIÓN DE LA CAJA 50233-48



Bandeja C2206 con 20 destornilladores y herramientas:

- 4 Destornilladores planos de 3, 4, 5.5 y 6.5mm.
- 1 Destornillador plano corto de 6.5mm
- 2 Destornilladores Phillips PH1 y PH.
- 1 Destornillador Phillips corto PH2
- 1 Juego 5102 de 10 llaves allen: 1.27, 1.5, 2, 2.5, 3, 4, 5, 6, 8 y 10mm.
- 5096P8 Flexómetro de 5m
- 68601 Lámpara LED de clip.



Bandeja C5166 con 16 alicates y llaves combinadas:

- 610B160 Alicata de punta de 160mm.
- 611B160 Alicata universal de 160mm.
- 612B160 Alicata de corte diagonal reforzado de 160mm.
- Juego de 13 llaves combinadas de 6 a 22:
- 6,7,8,9,10,11,12,13,14,15,17,19 y 22mm.



Bandeja C51221 con 12 herramientas:

- 60212150 Cincel de 12x150mm
- 60219180 Cincel de 19x180mm
- 616A400 Mazo de bicomponente de 400g.
- 616300 Martillo de mecánico de 300g.
- 613B250 Llave pico de loro de 250mm
- 614250 Mordaza pico de loro de 250mm.
- 649200C Llave ajustable de apertura amplia de 200mm.
- 6982 Tijera de electricista inox bicomponente
- 66302 Arco de sierra corto.
- 5055P3 2 hojas de sierra
- 5055P4 Cutter bicomponente con 2 hojas de 19mm

50235-101 CAJA DE 3 ALTURAS CON 101 HERRAMIENTAS

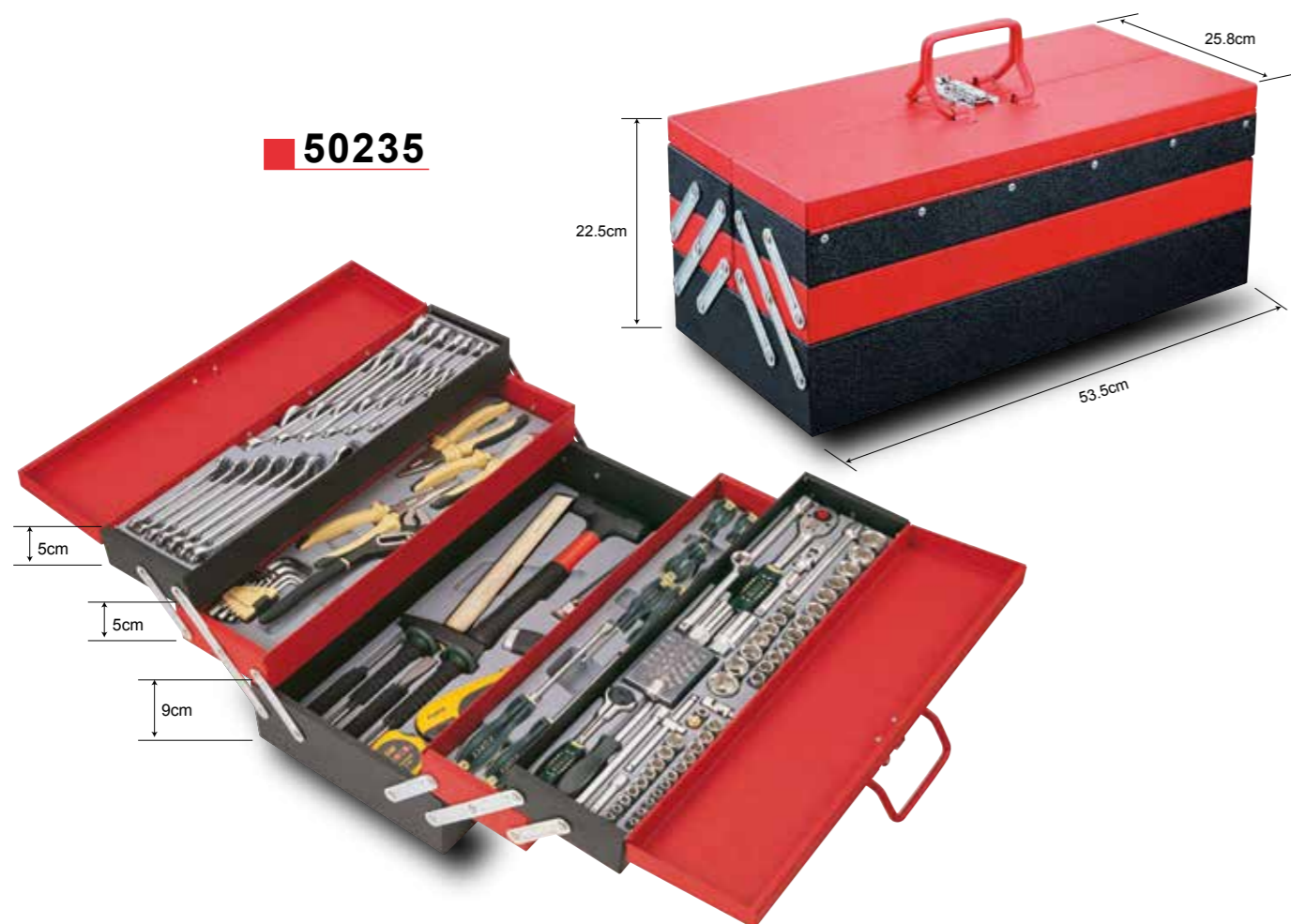

50235



C5153



C5142



C21114



C4482



C5136

DETALLE DE LA DOTACIÓN DE LA CAJA 50235-101



Bandeja C21114 con 11 :destornilladores:

- 4 Destornilladores planos de 3, 4, 5.5 y 6.5mm.
- 2 Destornilladores planos cortos de 5.5 y 6.5mm.
- 3 Destornilladores Phillips PH0, PH1 y PH2.
- 2 Destornilladores Phillips cortos PH1 y PH2.



Bandeja 4482 con juego de llaves de vaso de 48 pzs. ¼ y ½":
Contenido de ¼":

- 11 Vasos hexagonales de 4, 4.5, 5, 5.5, 6, 7, 8, 9, 10, 11 y 12mm.
- 2 Extensiones de 50 y 150mm, 1 articulación de ¼", 1 maneral corredizo de ¼".
- 1 Vaso portapuntas de ¼", 1 imán recogedor de ¼".
- 1 Carraca articulada de ¼ de 72 dientes y un destornillador portavasos de ¼".
- 4 Puntas phillips: PH0, PH1, PH2 y PH3.
- 4 Puntas pozi: PZ0, PZ1, PZ2 y PZ3.
- 2 Puntas planas de 5.5 y 6.5mm
- 1 Portapuntas de liberación rápida de ¼".

Contenido de ½":

- 13 Vasos hexagonales de ½": 10, 11, 12, 13, 14, 15, 16, 17, 18, 19, 21, 22 y 24mm.
- 1 Adaptador para maneral corredizo con prolongador
- 1 Articulación universal de ½"
- 1 Carraca de 24 dientes de ½".
- 2 Extensiones de 125 y 250mm de ½"



Bandeja C5142 con 3 alicates, llave pico de loro y llaves allen:

- 610B200 Alicates de punta de 200mm.
- 611B175 Alicates universal de 175mm.
- 612B175 Alicates de corte diagonal reforzado de 175mm.
- 613B250 Llave pico de loro de 250mm
- 5102 Juego de 10 llaves allen: 6 a 22: 6, 7, 8, 9, 10, 11, 12, 13, 14, 15, 17, 19 y 22mm.



Bandeja 5153 con 15 llaves combinadas:

- 8, 10, 11, 12, 13, 14, 15, 16, 17, 18, 19, 21, 22, 23 y 24mm.

DETALLE DE LA DOTACIÓN DE LA CAJA 50235-101 (CONTINUACIÓN)



- Bandeja C5136 con 13 herramientas:**
 50968P Flexómetro de 5m.
 6044190Q Botador de 4x190mm con protector.
 6045200Q Botador de 5x200mm con protector.
 6044190Q Botador de 6x210mm con protector.
 60215180Q Cincel de 15x180mm con protector.
 616400 Mazo de goma de 400g.
 616300 Martillo de mecánico de 300g.
 614250 Mordaza pico de loro de 250mm.
 649250A Llave ajustable de 250mm.
 66302 Arco de sierra corto.
 5055P3 2 hojas de sierra
 5055P4 Cutter bicomponente con 2 hojas de 19mm

50231-33
 NOTEBOOK CON 34 HERRAMIENTAS



Ref.	5/20/21/1.2'	4kg
Contenido:		
611B160	1-Alicate universal de 160mm	
612B160	1-Alicate de corte de 160mm	
613B250	1-Llave de pico de loro de 250mm	
616B16	1-Martillo de bola	
649200	1-Llave ajustable de 8" (200mmL)	
711 1...2	2-Destornilladores Phillips PH.1(80mm); PH.2(100mm)	
713 04...065	3-Destornilladores planos 4mm(100mm); 5.5mm(125mm); 6.5mm(150mm)	
755 08...19	8-Llaves combinadas 8; 10; 11; 12; 13; 14; 17; 19mm	
5072F	7-Juego de llaves Allen plegable 2.5; 3; 4; 5; 6; 8; 10; mm 8-	
5083F	Juego de llaves Torx plegable T9; T10; T15; T20; T25; T27; T30; T40	
9U3001	1-Cepillo de latón/nylon	

■50234 Maletín con ruedas



50223S-116 CAJA DE 3 CAJONES CON 116 HERRAMIENTAS



4721-5



20914



5252

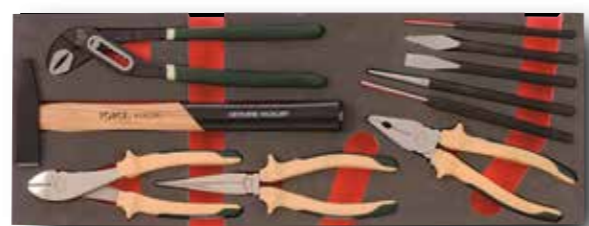

51012

DETALLE DE LA DOTACIÓN DE LA CAJA 50223S-116



Bandeja 20914 con 9 destornilladores:
 4 Destornilladores planos de 4, 5.5, 6.5 y 8mm.
 1 Destornillador plano corto de 6.5mm.
 3 Destornilladores Phillips PH0, PH1 y PH2.
 1 Destornillador Phillips corto PH2.



Bandeja superior 4721 con juego de llaves de vaso de 72 pzs.
Contenido de 1/4":
 12 Vasos poligonales de 4, 4.5, 5, 5.5, 6, 7, 8, 9, 10, 11, 12 y 13mm.
 3 Vasos poligonales largos de 8, 10 y 13mm.
 1 Extensiones de 50mm, 1 articulación de 1/4", 1 maneral corredizo de 1/4".
 1 Vaso portapuntas de 1/4", 1 imán recogedor de 1/4".
 1 Carraca de 1/4" y un destornillador portavasos de 1/4".
 4 Puntas phillips: PH0, PH1, PH2 y PH3.
 4 Puntas pozi: PZ0, PZ1, PZ2 y PZ3.
 5 Puntas planas de 4, 5, 5.5, 6 y 7mm.
 8 Puntas allen de 2, 3, 4, 5, 6, 7, 8 y 10mm.
 7 Puntas torx T10, T15, T20, T25, T27, T30 y T40.
Contenido de 1/2":
 13 Vasos poligonales de 1/2": 14, 15, 16, 17, 18, 19, 20, 21, 22, 24, 27, 30 y 32mm.
 3 Vasos poligonales largos de 1/2": 17, 19 y 21.
 1 Adaptador para maneral corredizo con prolongador 3/8H x 1/2 M
 1 Articulación universal de 1/2"
 1 Carraca de 24 dientes de 1/2".
 3 Extensiones de 75, 125 y 250mm de 1/2"



Bandeja 5252 con 16 llaves combinadas y juego de llaves allen:
 16 Llaves combinadas: 6, 7, 8, 9, 10, 11, 12, 13, 14, 15, 16, 17, 18, 19, 22 y 24mm.
 5093LB juego de 9 llaves allen: 1.5, 2, 2.5, 3, 4, 5, 6, 8 y 10mm.



Bandeja 51012 con 10 herramientas:
 6043150 Botador de 3x150mm.
 6044190 Botador de 4x190mm.
 60212150 Cincel de 12x150mm.
 603150 Butil de 150mm.
 6074185 Granete de 4x185mm.
 610B200 Alicata de punta de 200mm.
 611B185 Alicata universal de 175mm.
 612B175 Alicata de corte reforzado de 175mm.
 613B250 Llave pico de loro de 250mm.
 616200 Martillo de mecánico de 200g.

50223S-147 SAE CAJA DE 3 CAJONES CON 147 HERRAMIENTAS SAE

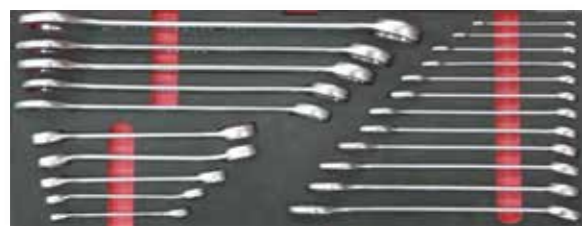

Bandeja superior



Primer cajón



Segundo cajón



Tercer cajón

DETALLE DE LA DOTACIÓN DE LA CAJA 50223S-147 SAE



Bandeja superior

Ref.	
755 1.4...1.5.16	17-Llaves combinadas SAE 1/4"; 5/16"; 3/8"; 7/16"; 1/2"; 9/16"; 5/8"; 11/16"; 3/4"; 13/16"; 7/8"; 15/16"; 1"; 1-1/16"; 1-1/8"; 1-1/4"; 1-5/16"
751 0810...1719	5-Llaves para racores SAE 5/16"x3/8"; 3/8"x7/16"; 1/2"x9/16"; 5/8"x3/4"; 11/16"x3/4"



Primer cajón

Ref.	
616300	1-Martillo de mecánico 300g
611175	1-Alicate universal de 180 mm
614250	1-Llave de pico de loro de 250mm
7111S	1-Destornillador Phillips corto PH.1
7111	1-Destornillador Phillips PH.1
7112M	1-Destornillador Phillips de golpe PH.1
713055S	1-Destornillador plano corto 5.5mm x 25mm
713055	1-Destornillador plano 5.5mm x 125mm
713065M	1-Destornillador plano de golpe 6.5mm x 150mm



Segundo cajón

Ref.	Contenido de 1/4":
12125 0...3	28-Puntas de 1/4" (25mm) Phillips PH.0; PH.1; PH.2; PH.3
12225 0...3	Pozidriv PZ.0; PZ.1; PZ.2; PZ.3
12325 04...07	Planas 4; 5; 5.5; 6.5; 7 mm
12425 1.16...3.8	Allen 1/16"; 3/32"; 1/8"; 5/32"; 3/16"; 1/4"; 5/16"; 3/8"
12625 10...40	Torx T10; T15; T20; T25; T27; T30; T40
529 5.32...9.16	11-Vasos poligonales de 1/4": 5/32"; 3/16"; 7/32"; 1/4"; 9/32"; 5/16"; 11/32"; 3/8"; 7/16"; 1/2"; 9/16"
526 04...08	5-Vasos Torx hembra E4; E5; E6; E7; E8 mm
80229	1-Carraca de 72 dientes
8042 050...150	3-Extensiones de 50, 100 y 150mm
80521	1-Articulación universal
80632	1-Adaptador para extensión 3/8"(H)x1/4"(M)
81022	1-Vaso portapuntas
81225	1-Vaso magnético
8143	1-Destornillador para vasos de 1/4"
	Contenido de 3/8":
539 1.4...15.16	14-Vasos poligonales de 3/8": 1/4"; 5/16"; 3/8"; 7/16"; 1/2"; 9/16"; 19/32"; 5/8"; 11/16"; 3/4"; 25/32"; 13/16"; 7/8"; 15/16"
80239	1-Carraca de 72 dientes
8043 075...150	2-Extensiones de 75 y 150mm
80531	1-Articulación universal
80643	1-Adaptador para extensión 1/2"(H)*3/8"(M)
5109S	Juego de 10 llaves Allen
764 1.16...1.2	1/16"; 5/64"; 3/32"; 1/8"; 5/32"; 3/16"; 1/4"; 5/16"; 3/8"; 1/2"



Tercer cajón

Ref.	Contenido de 1/2":
549 5.16...1.1.4	19-Vasos poligonales de 1/2": 5/16"; 3/8"; 7/16"; 15/32"; 1/2"; 9/16"; 19/32"; 5/8"; 11/16"; 3/4"; 25/32"; 13/16"; 7/8"; 15/16"; 1"; 1-1/16"; 1-1/8"; 1-3/16"; 1-1/4"
546 10...20	6-Vasos Torx hembra E10; E12; E14; E16; E18; E20
8014430	1-Maneral basculante (430mm)
80249	1-Carraca de 72 dientes
8044 075...250	2-Extensiones de 75 y 250mm
80541	1-Articulación universal
80634	1-Adaptador para extensión 3/8"(H) x 1/2"(M)
8074 16...20.6	2-Vasos para bujías 16 & 20.6 mm
8154260	1-Maneral en L

50229S-94 CAJA DE 9 CAJONES CON 94 HERRAMIENTAS

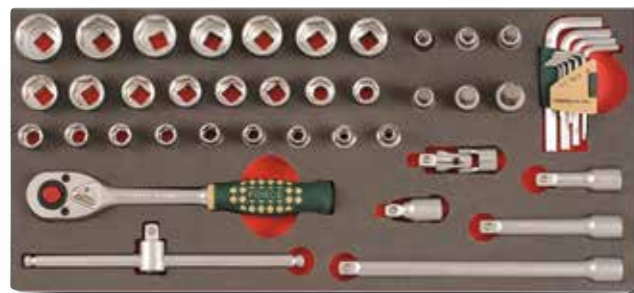

4461

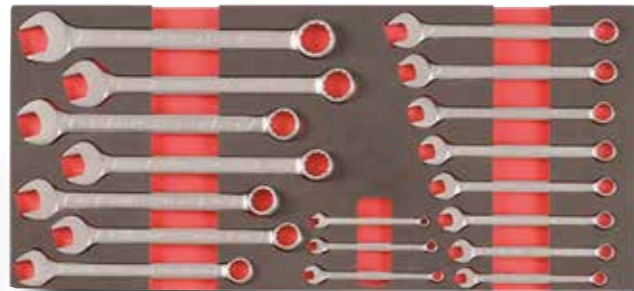

5185



2033



5024



5205



5039



5021V

DETALLE DE LA DOTACIÓN DE LA CAJA 50229S-94

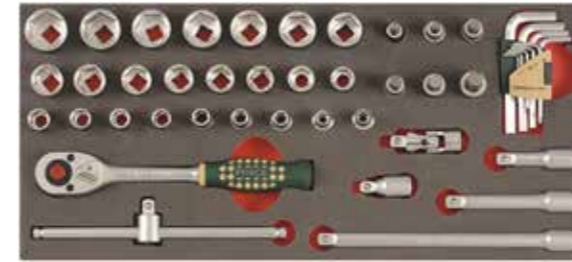

Bandeja superior 4461 con juego de llaves de vaso de 46 pzs. de ½":
 24 Vasos hexagonales de ½: 8, 9, 10, 11, 12, 13, 14, 15, 16, 17, 18, 19, 20, 21, 22, 23, 24, 25, 26, 27, 28, 29, 30 y 32mm.
 6 Vasos allen de ½: 7, 8, 9, 10, 12 y 14mm.
 1 Articulación universal de ½
 1 Carraca de 24 dientes de ½
 1 Maneral corredizo de ½"
 4 Extensiones de 75, 100, 125 y 250mm de ½"
 5093 Juego de llaves allen de 9 pzs.: 1.5, 2, 2.5, 3, 4, 5, 6, 8 y 10mm.

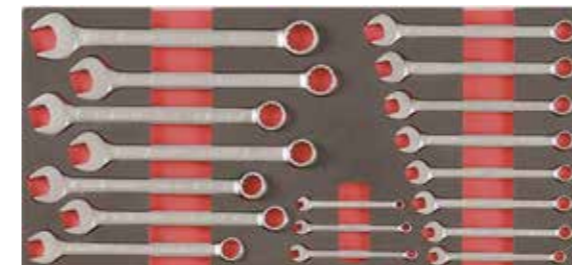

Bandeja 5185 con 18 llaves combinadas:
 18 Llaves combinadas: 6, 7, 8, 9, 10, 11, 12, 13, 14, 15, 16, 17, 18, 19, 20, 21, 22 y 24mm.



Bandeja 5039 con 3 alicates:
 610B200 Alicata de punta de 200mm.
 611B185 Alicata universal de 175mm.
 612B175 Alicata de corte reforzado de 175mm.



Bandeja 2033 con 3 destornilladores:
 7111N Destornillador 1000V Phillips PH1.
 71304N Destornillador 1000V plano de 4mm.
 88401 Destornillador buscapolos 110-250V.



Bandeja 5024:
 649200C Llave ajustable de apertura extra de 200mm.
 5055P4 Cutter bicomponente con 3 hojas.



Bandeja 5021V:
 613250 Llave pico de loro de 250mm.
 614250 Mordaza grip de 250mm.

DETALLE DE LA DOTACIÓN DE LA CAJA 50229S-94 (CONTINUACIÓN)



Bandeja 5205 con 20 herramientas:

- 2 Destornilladores planos de 5.5 y 6.5mm. Martillables.
- 1 Destornillador plano de 4mm.
- 2 Destornilladores Phillips PH1 y PH2 martillables.
- 6062185 Botador cónico de 2 x 185mm.
- 6063185 Botador cónico de 3 x 185mm.
- 6064185 Botador cónico de 4 x 185mm.
- 6074185 Granete de 4x185mm.
- 6078185 Granete de 8x185mm.
- 6042140 Botador de 2x140mm.
- 6043150 Botador de 3x150mm.
- 6044190 Botador de 4x190mm.
- 60212150 Cincel de 12x150mm.
- 60219220 Cincel de 19x220mm.
- 60225220 Cincel de 25x220mm.
- 603150 Buril de 150mm.
- 616500 Martillo de mecánico de 500g.
- 616A400 Martillo de cabezas de nylon y ptfе.
- 88601 Imantador/desimantador.

3313 JUEGO DE 31 HERRAMIENTAS AISLADAS 1000V DE 3/8"



Contenido:

- 14 Vasos poligonales aislados 1000V de 3/8" 6; 7; 8; 9; 10; 11; 12; 13; 14; 15; 16; 17; 18; 19 mm
- 5 Llaves fijas de una boca aisladas 1000V 7; 8; 10; 12; 14 mm
- Extensiones aisladas 1000V de 3/8": 150 y 250mm
- Carraca aislada 1000V de 3/8"
- Destornillador buscapolos 110~250V AC
- Alicate universal aislado 1000V de 175mm
- Alicate de punta aislado 1000V de 150mm
- Alicate de core aislado 1000V de 150mm
- 2 Destornilladores Phillips aislados 1000V: PH.1(80mm); PH.2(100mm)
- 3 Destornilladores Planos aislados 1000V: 2.5(75mm); 4(100mm); 5.5(125mm)

3/11.9/12.5/1.5'

4000g

10225R APARADOR DE 5 CAJONES CON LLAVE



60mm
60mm
60mm
60mm
60mm
60mm

69 x 46 x 49 cm

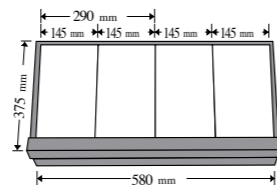

Apilable sobre los carros 10217R

10225R



Juego de botadores y cinces de 5 pzs.

5054		
Ref.	40/20.2/21.5/1.3'	505g

60212150	Contenido:
603150	1-Cinzel de 12 x 150mm
6044190	1-Buril de 150mm
6063185	1-Botador de 4 x 190mm
6074185	1-Botador cónico de 3 x 185mm
	1-Granete de 4 x 185mm



Juego de cinces de 5 pzs.

50510		
Ref.	30/26.5/27.6/0.5'	887g

602 10150...22200	Contenido:
	1-Cinzel de 10 x 150mm
	1-Cinzel de 12 x 150mm
	1-Cinzel de 15 x 180mm
	1-Cinzel de 19 x 200mm
	1-Cinzel de 22 x 200mm



Juego de granetes de 5 pzs.

50511		
Ref.	30/18.8/19.8/0.5'	627g

607 25185...10185	Contenido:
	1-Granete de 2.5 x 185mm
	1-Granete de 4 x 185mm
	1-Granete de 6 x 185mm
	1-Granete de 8 x 185mm
	1-Granete de 10 x 185mm



Juego de botadores cónicos de 5 pzs

50512		
Ref.	30/14.4/15.4/0.5'	480g

606 2185...6185	Contenido:
	1-Botador cónico de 2.5 x 185mm
	1-Botador cónico de 3 x 185mm
	1-Botador cónico de 4 x 185mm
	1-Botador cónico de 5 x 185mm
	1-Botador cónico de 6 x 185mm



Juego de botadores de 6 pzs.

50613		
Ref.	30/16.7/17.7/1.3'	540g

604 2140...8215	Contenido:
	1-Botador de 2 x 140mm
	1-Botador de 3 x 150mm
	1-Botador de 4 x 190mm
	1-Botador de 5 x 200mm
	1-Botador de 6 x 210mm
	1-Botador de 8 x 215mm



Juego de botadores de 6 pzs.

50614		
Ref.	100/23.6/24.6/0.9'	236g

605 19090...79150	Contenido:
	1-Botador de 1,9 x 90mm
	1-Botador de 2.9 x 95mm
	1-Botador de 3.9 x 115mm
	1-Botador de 4.9 x 115mm
	1-Botador de 5.9 x 140mm
	1-Botador de 7.9 x 150mm



Juego de cinces y botadores de 13 pzs.

5131		
Ref.	6/13.0/14.0/0.9'	2167g

602 10150...22200	Contenido:
	5- Cinceles
	10 x 150mm; 12 x 150mm;
	15 x 180mm; 19 x 200mm;
	22 x 200mm
603150	1- Buril de 150mm
604 2140...4190	3- Botadores
	2 x 140mm; 3 x 150mm;
	4 x 190mm
606 2185...4185	3- Botadores cónicos
	2 x 185mm; 3 x 185mm;
	4 x 185mm
6074185	1- Granete de 4 x 185mm



Juego de cinces y botadores de 18 pzs.

K5183		
Ref.	6/13.0/14.0/0.9'	3200g

602 10150...25220	Contenido:
	6-Cinceles
	10 x 150mm; 12 x 150mm;
	15 x 180mm; 19 x 200mm;
	22 x 200mm; 25 x 220mm
603150	1-Buril de 150mm
6042140...8215	6-Botadores
	2 x 140mm; 3 x 150mm;
	4 x 190mm; 5 x 200mm;
	6 x 210mm; 8 x 215mm
6064185...8185	4-Botadores cónicos
	4 x 185mm; 5 x 185mm;
	6 x 185mm; 8 x 185mm 1-
6074185	Granete
	4 x 185mm



Botador cilíndrico con protección

604...Q	Medida	<i>l</i>		
Ref.	mm	mm	g	Uds/Caja
6042140Q	2	140	58	10
6043150Q	3	150	59	10
6044190Q	4	190	105	10
6045200Q	5	200	106	10
6046210Q	6	210	147	10



Cinzel con protección

602...Q	Medida	<i>l</i>		
Ref.	mm	mm	g	Uds/Caja
60210150Q	10	150	100	10
60212150Q	12	150	102	10
60215180Q	15	180	168	10



Botador cilíndrico con protección

606...Q	Medida	<i>l</i>		
Ref.	mm	mm	g	Uds/Caja
6062185Q	2	185	114	10
6063185Q	3	185	115	10
6064185Q	4	185	116	10
6065185Q	5	185	119	10



Cortafrió

602...C	Medida	<i>l</i>		
Ref.	mm	mm	g	Uds/Caja
60226200C	26	200	320	10
60229250C	29	250	470	5
60234300C	34	300	750	5



Granete con protección

607...Q	Medida	<i>l</i>		
Ref.	mm	mm	g	Uds/Caja
60725185Q	2.5	185	114	10
6074185Q	4	185	116	10
6076185Q	6	185	120	10



Cortafrió con protección

602...Q	Medida	<i>l</i>		
Ref.	mm	mm	g	Uds/Caja
60229250Q	29	250	540	10
60234300Q	34	300	820	5



Juego de destorgolpe de 17 Pzs.

5171		
Ref.	20/22.0/23.0/0.82'	1100g
8174	Contenido de 1/2" 1-Atornillador de golpe 14- Puntas de 5/16"	
15136 2...3	Phillips: PH.2; PH.3 x 36mm	
15236 2...3	Pozidriv PZ.2; PZ.3 x 36mm	
15336 09...11	Planas 9; 11 mm x 36mm	
15635 25...50	Torx T25; T30; T40; T45; T50 x 35mm	
15436 06...10	Allen 6; 8; 10 x 36mm	
81045A	1-Portapuntas de golpe 1/2"x5/16"	
8095330	1-Adaptador 5/16"Hex-3/8".	



Juego de limas de 5 pzs.

5056		
Ref.	6/10.2/11.2/0.9'	1690g
5056P1	Contenido: 1-Lima plana de 8"	
5056P2	1-Lima mediacaña de 8"	
5056P3	1-Lima redonda de 8"	
5056P4	1-Lima cuadrada de 8"	
5056P5	1-Lima triangular de 8"	



Arco de sierra de 6"

66302		
Ref.	72/15.7/16.7/1'	218g

Empuñadura ergonómica de goma
Para plástico madera o metal
Hojas de 150mm
66302B hoja de repuesto



Arco de sierra de 12" de empuñadura

66303	<i>l</i>		
Ref.	135mm	72/15.7/16.7/1'	100g

Empuñadura ergonómica de goma
Hojas estándar de 12"



Arco de sierra de 12" Heavy Duty

66301		
Ref.	24/22.0/23.0/1.9'	916g

Empuñadura ergonómica de goma
Sistema de cambio de hoja rápido
Hojas estándar de 12"



Mazo de goma antirrebote

616		<i>l</i>	
Ref.	Envase	mm	g
616260	72/25.0/27.0/1.71'	262	350
616400	48/26.0/28.0/1.62'	280	520
616580	36/25.0/27.0/1.61'	300	690
616810	24/23.0/25.0/1.35'	320	940



Martillo de doble componente

616A400		
Ref.	Envase	g
616A400	48/19.2/20.2/1.62'	400g

Mango de nogal americano.
Cabeza de dos componentes, Nylon y PU.



Martillo de mecánico

616		
Ref.	Envase	g
616200	84/20.8/22.2/1.11'	240
616300	48/20.7/22.7/1.11'	431
616500	36/22.0/23.5/1.19'	611
6161000	16/20.0/21.3/0.91'	1250
6161500	12/21.0/22.1/0.84'	1750



Martillo de doble componente

616A700		
Ref.	Envase	g
616A700	30/21.0/22.0/1.3'	700g

Mango de acero con empuñadura de PVC
Cabeza de dos componentes, TPR y acetato.



Mazo de nylon antirrebote

616A	<i>l</i>	
Ref.	mm	g
616A025	25	389
616A030	30	435
616A035	35	505
616A040	40	606
616A045	45	865
616A050	50	952
616A055	55	1038
616A060	60	1125

Mango de acero con empuñadura de goma.
Cabezas de nylon.



Martillo de peña

616F			
Ref.	Size	Envase	g
616F032	32mm	36/23.5/24.9/1.06'	600
616F035	35mm	24/19.4/20.5/0.85'	760
616F040	40mm	24/25.5/26.8/1.04'	1040

Cabeza de acero carbono 1055 pulida y pintada
Mango de nogal americano.



Tijera de electricista

6982		<i>l</i>	
Ref.	Envase	mm	g
6982	72/7.0/9.0/1.4'	145mm	80g

Diseñada para cortar y pelar cables eléctricos de hasta 2mm de diámetro.
Filos aserrados para evitar deslizamientos.
Tornillo ajustable
Empuñadura bicomponente de larga duración



Corte recto

Tijera de chapa de muelle

698		<i>l</i>	<i>l</i>	
Ref.	Sentido	mm	Corte	g
6981250	Corte recto	250	38mm	400



Tijera de electricista

6983		<i>l</i>	
Ref.	Envase	mm	g
6983	72/4.3/5.3/1.1'	145	60

Empuñadura de ABS
2.5mm de espesor



Tenaza de encofrar

6971		<i>l</i>	
Ref.	Envase	mm	g
6971250	40/19.2/20.2/1.2'	250	480



Tijeras de chapa rectas

5055P1		<i>l</i>	
Ref.	Largo del corte	mm	g
5055P108	40mm	203-8"	340
5055P1	51mm	254-10"	480



Tenaza de carpintero

6972180		<i>l</i>	
Ref.	Envase	mm	g
6972180	60/18.9/19.9/1.2'	180	315



Alicate de punta recta extra largo de 15.7"

5047P1				
Ref.	Envase	mm	g	Ud/Caja
5047P1L	50/17.5/18.5/0.83'	400-15.7"	480	5



Alicate de punta a 45° extra largo de 15.7"

5047P2				
Ref.	Envase	mm	g	Ud/Caja
5047P2L	50/17.5/18.5/ 1.1'	400-15.7"	480	5



Alicate de punta a 90° largo de 11"

5047P3				
Ref.	Envase	mm	g	Ud/Caja
5047P3	50/16.5/17.5/0.64'	280-11"	330	5



Alicate de punta de anillo largo de 11"

5047P4				
Ref.	Envase	mm	g	Ud/Caja
5047P4	50/16.5/17.5/0.64'	280-11"	330	5



Juego de alicates extra largos de 4 pzs.

5047		
Ref.	Envase	g
5047	6/11.8/12.8/0.9'	1970g

Contenido:
 1-Alicate de punta recto largo de 11"
 1-Alicate de punta a 45° largo de 11"
 1-Alicate de punta a 90° largo de 11"
 1-Alicate de punta de anillo largo de 11"



Alicate de punta

610B			
Ref.	Envase	mm	g
610B160	50/9.3/10.3/1.2'	160-6.3"	186
610B200	50/11.0/12.0/2'	200-8"	220



Alicate de punta curva

610B..B			
Ref.	Envase	mm	g
610B200B	50/11.0/12.0/1.9'	200-8"	220



Alicate universal

611B			
Ref.	Envase	mm	g
611B160	60/15.7/16.7/1.5'	160-6.3"	261
611B175	60/16.8/17.8/2'	175-7"	280
611B200	60/22.8/23.8/1.8'	200-8"	380



Alicate de corte reforzado

612B			
Ref.	Envase	mm	g
612B160	60/14.3/15.3/1.6'	160-6.3"	238
612B175	60/15.6/16.6/2'	175-7"	260



Juego de alicates de 4 pzs.

5046		
Ref.	Envase	g
5046	6/9.9/10.9/0.9'	1650g

Contenido:
 1-Alicate de punta de 200mm
 1-licate de punta curva de 200mm
 1-Alicate universal de 180mm
 1-Alicate de corte reforzado de 180mm

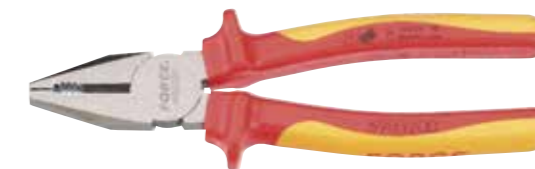

Alicate universal aislado 1000V

6903			
Ref.	Envase	mm	g
6903180	60/18.0/19.0/0.93'	180-7"	300



Alicate de punta aislado 1000V

6904			
Ref.	Envase	mm	g
6904160	60/11.1/12.1/0.64'	160-6"	185



Alicate de corte diagonal aislado 1000V

6905160			
Ref.	Envase	mm	g
6905160	60/14.4/15.4/0.9'	160-6"	240



Alicate de puntas redondas aislado 1000V

6908160			
Ref.	Envase	mm	g
6908160	60/10.2/11.2/0.64"	160-6"	170



Alicate pelahilos aislado 1000V

Ref.	Envase	l	g
6912160	60/11.4/12.4/1.6'	160-6"	190



Alicate cortacables aislado 1000V

Ref.	Envase	mm	g
6914	60/10.8/11.8/1.3'	160-6"	180



Navaja de electricista

Ref.	Envase	mm	g
68021	100/8.4/9.4/1.8'	210/122	64



Cuchillo para pelar cables de 8 a 28mm

Ref.	Envase	mm	g
6809	60/10.8/11.8/1.3'	125	100



Pelahilos de 0.8-2.6 y cables de 9.5mm

Ref.	Envase	mm	g
68011	200/25.5/26.5/3.1'	100	125



Alicate para terminales

Ref.	Envase	mm	g
6801	30/15.8/16.8/1.5'	233	528



Alicate para terminales 5.5; 0.75; 1.0; 1.5; 2.5 y 4

Ref.	Envase	mm	g
6802	30/16.5/17.5/1.5'	233	549



Alicate para terminales 0.5-1; 1.1-2.5; 4-6

Ref.	Envase	mm	g
6803	30/16.1/17.1/1.5'	233	535



Alicate para terminales RG58,59,62 BNC/TNC

Ref.	Envase	mm	g
6807	30/16.1/17.1/1.5'	233	535



Alicate para terminales RJ

Ref.	Envase	mm	g
68012	48/19.0/20.0/1.5'	210	400g

Cortar, pelar y crimpar con una sola herramienta. Con tope longitudinal para limitar la cantidad de cable a pelar. Válido para terminales RJ45 y RJ11 Sistema de presión de carraca Cuchilla para cortar cables telefónicos.



Alicate pelacables Heavy Duty

Ref.	Envase	mm	g
6805	60/21.0/22.0/2.3'	210	311

Corta y pela cable de 10-24 AWG de cobre o aluminio Para prensar: Terminales aislados de 10-22 AWG Terminales no aislados de 4-22 AWG Terminales de ignición de 7 a 8mm



Alicate prensaterminales múltiple

Ref.	Envase	mm	g
6806	40/11.8/12.8/1'	245	251

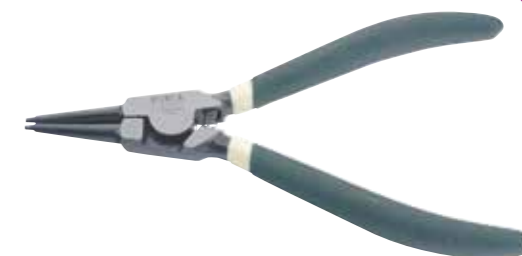

Alicate para anillos exteriores recto

Ref.	Capacidad	Envase	mm	g
609ASO	19-60mm	30/4.5/5.5/0.69'	180-7"	150

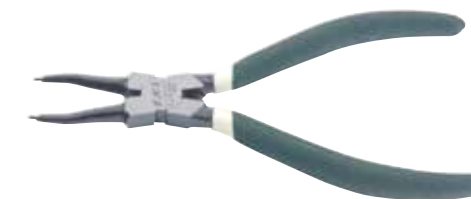

Alicate para anillos interiores recto

Ref.	Capacidad	Envase	mm	g
609ASC	19-60mm	30/4.5/5.5/0.69'	180-7"	150



Alicate para anillos exteriores curvo

Ref.	Capacidad	Envase	mm	g
609ABO	19-60mm	30/4.5/5.5/0.69'	180-7"	150



Alicate para anillos interiores recto

Ref.	Capacidad	Envase	mm	g
609ABC	19-60mm	30/4.5/5.5/0.69'	180-7"	150

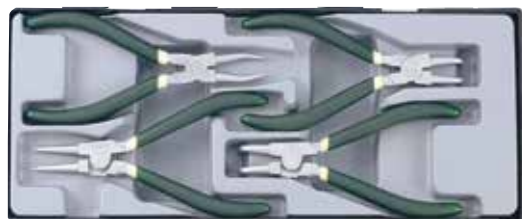

Juego de alicates para anillos de 4 pzs.

5043A		
Ref.	6/9.5/10.5.8/0.9'	1800g

609ASO
609ASC
609ABO
609ABC

Contenido:
4-Alicates para anillos de presión
Recto para anillos exteriores
Recto para anillos interiores
Curvo para anillos exteriores
Curvo para anillos interiores



Alicate compuesto para anillos de presión

9T0101		
Ref.	Envase	mm g
9T0101	36/14.2/15.2/1.7'	250 395g

Construido con acero forjado. Para anillos exteriores.
Alicate compuesto para mayor amplitud de apertura
con menor esfuerzo.
Apertura: 27mm



Alicate de punta oblicua para anillos

9T0104		
Ref.	Envase	mm g
9T0104	48/14.4/15.4/0.75'	230 300g

Construido con acero forjado.
Con dentado transversal
Apertura: 38mm



Alicate para trenzar alambre

6958		
Ref.	Envase	mm g
6958225	60/22.1/23.1/1.1'	225 360



Mordaza grip

614		
Ref.	Envase	mm g
614175	40/14.8/15.8/0.96'	175-7" 370
614250	40/22.0/23.0/1'	250-10" 550



Mordaza grip de 10" de boca recta

614A		
Ref.	mm-inch	Envase g
614A250	250-10"	40/23.2/24.2/1.0' 580



Mordaza grip de soldar

66201		
Ref.	Envase	g
	40/22.8/23.8/1.4'	600g



Cortavarillas

9U0501		
Ref.	Envase	Largo g
9U050112	20/16.6/17.6/2.1'	300-12" 830
9U050114	20/24/25/2.1'	355-14" 1200
9U050118	15/24.2/25.2/2.3'	455-18" 1613
9U050124	8/19/20/2.7'	610-24" 2375
9U050130	6/23.8/24.8/2.1'	762-30" 3967
9U050136	5/30.4/31.4/1.8'	863-36" 6080
9U050142	3/28.0/29.0/2'	1095-42" 8320



Cortacables de 310mm

6927310	Cable de acero:	
Ref.	7mm	mm g
6927600	Cobre 60 mm2	310 1200



Cortacables de 600mm

6927600	Cable de acero:	
Ref.	14mm	mm g
6927600	Cobre 150 mm2	600 2500



Remachadora

67801		
Ref.	Envase	mm g
67801	20/15.7/16.7/2.1'	180 785



Remachadora de dos manos

678535		
Ref.	Envase	Cap. g
678535	10/17.5/18.5/1.6'	3 a 6.4m 1890g



Remachadora para remaches de tuerca

5861		
Ref.	6/5.8/6.8/0.9'	960g
67802	Contenido: Remachadora para remaches tuerca con tornillo de M6 3 Tornillos:	
5861-M3	M3 x 0.5	
5861-M4	M4 x 0.7	
5861-M5	M5 x 0.8	
5861-S	1 Llave	
5861-1	20 remaches tuerca de 5.1mm	
5861-2	20 remaches tuerca de 6.1mm	
5861-3	20 remaches tuerca de 7.1mm	
5861-4	20 remaches tuerca de 9.1mm	



Llave de pico de loro

613		<i>l</i>	
Ref.	Envase	mm	g
613200	60/13.5/14.5/1.5'	200-8"	225
613250	50/23.7/24.7/1.6'	250-10"	470
613300	20/18.8/19.8/1.1'	300-12"	680
613410	12/15.6/16.6/0.5'	410-16"	1300



Llave de pico de loro

613B250		<i>l</i>	
Ref.	Envase	mm	g
613B250	50/20.5/21.5/1.7'	250-10"	410



Llave ajustable

649		<i>l</i>	
Ref.	largo	Envase	mm g
649150	20mm	100/17.0/18.0/1.6'	150 170
649200	24mm	60/17.4/18.4/2.1'	200 290
649250	29mm	30/15.0/16.0/1.5'	250 500
649300	33mm	20/15.3/16.3/1.2'	300 765
649375	46mm	12/15.6/16.6/1.3'	375 1300
649450	60mm	10/19.0/20.0/0.7'	450 2150



Llave ajustable de apertura extra

649200C		<i>l</i>	
Ref.	Envase	mm	g
649200C	50/16.0/17.0/1'	200	280

Materia: Acero al Cromo Vanadio
 Con escala grabada
 Asa forjada
 Movimiento de apertura y cierre rápido, suave y preciso
 Apertura máxima de 38mm
 Empuñadura bicomponente



Llave ajustable de trinquete

649200D		<i>l</i>	
Ref.	Envase	mm	g
649200D	40/10.8/11.8/1'	200	270

Materia: Acero al Cromo Vanadio
 Función de trinquete patentada
 Empuñadura bicomponente



Llave de carraca para radiadores

4031		
Ref.	Envase	g
Ref.	20/17.0/18.0/1.4	850g

Contenido: 1/2".
 1-Carraca hembra de 1/2"
 1-Llave de escalonada cuadrada de:
 1.5x8.9; 3/8"(9.35mm); 7/16"(9.75mm);
 15/32"(12mm); 1/2"(12.8mm);
 35/64"(13.8mm); 3/4"(18.4mm);
 27/32"(21.4mm); 7/8"(21.9mm)
 1-Llave de escalonada hexagonal de:
 3/8"; 1/2"; 3/4"; 1"



Llave stillson de aluminio

684...A		<i>l</i>	
Ref.	Envase	Largo	g
68410A	24/11.0/12.0/0.65'	250-10"	460
68412A	24/17.0/18.0/1.2'	300-12"	700
68414A	12/11.5/12.5/0.6'	355-14"	895
68418A	12/18.0/19.0/1.2'	455-18"	1500
68424A	6/14.0/15.0/1'	610-24"	2330
68436A	3/14.0/15.0/1.1'	863-36"	4660



Llave stillson de acero forjado

684		<i>l</i>	
Ref.	Envase	Largo	g
68410	24/17.0/18.0/0.65'	250-10"	710
68412	24/23.0/24.0/1.2'	300-12"	960
68414	12/16.0/17.0/0.6'	355-14"	1340
68418	12/25.0/26.0/1.2'	455-18"	2090
68424	6/22.0/23.0/1'	610-24"	3670
68436	3/25.0/26.0/1.1'	863-36"	8340
68448	2/24.0/25.0/1'	1220-48"	12000



Escariador para tubos

65304	
Ref.	g
65304	35g

Capacidad hasta 1.1/2"

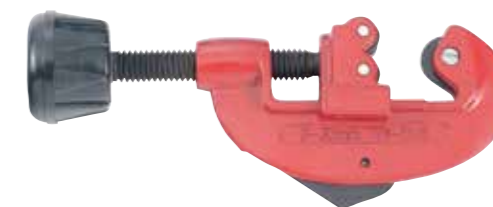

Cortatubos para hierro

65601	Capacidad		
Ref.	Envase	Largo	g
65601	3-32mm	60/17.0/18.0/2.1'	283g

Cuchilla de repuesto: 65601-B



Cortatubos mini

65602	Capacidad		
Ref.	Envase	Largo	g
65602	3-22mm	100/14.0/15.0/1.2'	140g

Cuchilla de repuesto: 65602-B



Cortatubos telescópico

65608	Capacidad		
Ref.	Envase	Largo	g
65608	3-32mm	60/17.0/18.0/2.1'	283g

Cuchilla de repuesto: 65608-B



Cortatubos para hierro 2"

65605	<i>l</i>	
Ref.	Envase	g
65605	43cm	3.1kg

Capacidad de 12 a 50mm en hierro
 Cuchilla de repuesto: 65605-B



Cizalla de acero inoxidable para PVC

65607		
Ref.	225mm	490g

Capacidad: Tubo de PVC de 42mm



Juego de corte y abocardado de tubos SAE

656		
Ref.	10/18.0/19.0/1.8'	1800g

Contenido: 1 Cortatubos
1 Abocardador y guía de soporte
7 Adaptadores: 3/16"; 1/4"; 5/16"; 3/8"; 7/16"; 1/2"; 5/8"

Juego de corte y abocardado de tubos MM

656M		
Ref.	10/17.2/18.2/1'	1720g

Contenido: 1 Cortatubos
1 Abocardador y guía de soporte
7 Adaptadores: 4; 6; 8; 10; 12; 14; 16mm(5/8")



Llave dinámometrica

Ref.	Capacidad Nm	Envase		
	Nm		mm	g
6472295	1/4" 6-30	20/19.0/20.0/1.12'	295	950
6473295	3/8" 6-30	20/18.1/19.1/1.12'	295	905
6473380	1/2" 19-110	12/13.7/14.7/1.57'	380	1140
6474535	3/4" 40-210	10/21.0/22.0/1.31'	535	2100
6474660	1" 70-350	6/17.9/18.9/0.92'	660	2980
6476880	1 1/2" 100-500	4/18.7/19.7/1.07'	880	4675
64761095	2" 140-700	4/31.0/32.0/1.93'	1095	7750



Llave dinámometrica con visor

Ref.	Capacidad Nm		
	Nm	mm	g
6473360W	3/8" 5~50	360	920
6474500W	1/2" 20~200	500	1200



Llave dinámometrica con visor

Ref.	Capacidad Nm		
	Nm	mm	g
6472195W	1/4" 3-15Nm	195	215



Juego de dinámometrica con cabezas intercambiables de 8 pzs.

64704		
Ref.	6/19.5/20.5/1.2'	3250g

Contenido:
1- Llave dinámometrica de 15~80Nm
647H414A 1- Cabezal de carraca de 1/2".
68514 17...29 6- Bocas de llave abiertas 17; 22; 24; 26; 27; 29 mm



Juego de dinámometrica con cabezas intercambiables de 11 pzs.

64705		
Ref.	4/17.9/18.9/0.96'	4470g

Contenido:
647B210 1- Llave dinámometrica de 40~210Nm
647H414 1- Cabezal de carraca de 1/2".
68514 13...30 9- Bocas de llave abiertas 13; 14; 15; 17; 19; 22; 24; 27; 30 mm

647B210 1- Llave dinámometrica de 40~210Nm



Llaves de boca abierta para dinámometrica con base de 14x18mm

Ref.	Medida (mm)
6851413	13
6851414	14
6851415	15
6851416	16
6851417	17
6851418	18
6851419	19
6851421	21
6851422	22
6851424	24
6851426	26
6851427	27
6851429	29
6851430	30
6851432	32



Llaves de estrella para dinámometrica

Ref.	Medida (mm)	Ref.	Medida (mm)
685A14			
685A1413	13	685A1427	27
685A1414	14	685A1430	30
685A1415	15	685A1432	32
685A1416	16		
685A1417	17		
685A1418	18		
685A1419	19		
685A1421	21		
685A1422	22		
685A1424	24		



Multiplicador de torque

65111L		
Ref.	3/10.5/11.5/1.2'	3500g
65111	Contenido: Multiplicador de par de 1/2"H x 3/4"M 1500Nm máximo de salida y barra de reacción de 380mm	
65111L-1	Barra de reacción de 90°	
65111L-2	Base de reacción de 90°	
65111L-3	Adaptador	



Multiplicador de torque

65113L		
Ref.	3/10.5/11.5/1.2'	3500g
65113	Contenido: Multiplicador de par de 3/4"H x 1"M 2500Nm máximo de salida y barra de reacción de 380mm	
65113L-1	Barra de reacción de 90°	
65113L-2	Base de reacción de 90°	
65113L-3	Adaptador	



Destornillador de torque con puntas.

K64706		
Ref.	24/21.7/22.7/1.5'	905g
6472150	Contenido: 1/4"	
81022	1- Atornillador de torque de 1 a 5 Nm	
8042100	1- Portapuntas de 1/4"H x 1/4"hex.	
12125 0...3	1- Extensión 4"	
12223 0...3	4- Puntas Phillips(25mm) PH.0; PH.1; PH.2; PH.3	
12325 03...065	4- Puntas Pozidriv (25mm) PZ.0; PZ.1; PZ.2; PZ.3	
12425 015...06	5- Puntas planas 3; 4; 5; 5.5; 6.5 mm	
124R25 1...3	6- Puntas allen 1.5; 2; 3; 4; 5; 6 mm	
12625 06...40	3- Puntas cuadradas 1; 2; 3 mm	
12725 06...40	11-^Puntas Torx T6; T7; T8; T9; T10; T15;T20; T25; T27; T30; T40	
	11-Puntas Torx inviolables T-6H; T-7H; T-8H; T-9H; T-10H; T-15H;T-20H; T-25H; T-27H; T-30H; T-40H	



Soporte mural para herramientas

63201		
Ref.	100/14.0/15.0/2.9'	140g

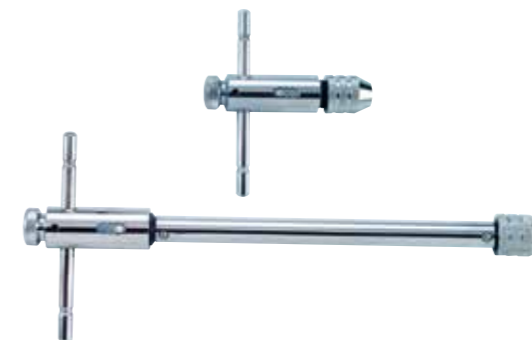

Giramachos de carraca

881			
Ref.	Medidas de rosca	l	g
8812090	1/8"-1/4" (3-6mm)	90	190
8814110	1/4"-1/2" (6-12mm)	110	320



Juego de 5 extractores de espárragos

63005		
Ref.	100/13.4/14.4/1.4'	134g
63005	7/64"; 9/64"; 5/32"; 1/4"; 19/64"	



Juego de 8 extractores de espárragos

63006B		
Ref.	24/19.9/20.9/0.79'	830g
63006B	5/64"; 7/64"; 5/32"; 1/4"; 19/64"; 13/32"; 17/32"; 13/16"(CR-MO)	

Juego de 7 extractores de espárragos

5078



• Para sacar espárragos dañados.

Contenido:

7 Extractores para espárragos de:
5; 6; 7; 8; 10; 12; 14 mm



12/16.8/17.8/0.73' 1400g

Extractor de espárragos

818A



Cuadradillo de 1/2"

Para sacar espárragos dañados

Rango de aplicación: 6 - 19mm (1/4" - 3/4")



30/16.9/17.9/0.55' 560g

Extractores de espárragos

818B



Rango de aplicación en espárragos de 6 a 12mm (1/4" - 1/2")

Ref.	DR.	l mm	 g	 Envase
818B02	1/2"	75	395	48/19.0/20.0/1.8'



Juego de vsos de impacto para tornillos dañados de 6pzs.

906U2



• Para sacar tornillos y tuercas dañados u oxidados.

Contenido:

5 Vasos de impacto de 1/2" x 50mm para tornillos dañados:
17; 19; 21; 23; 27mm



20/19.8/20.8/1.4' 990g

Juego de vsos de impacto para tornillos dañados de 12 pzs.

912U3



• Para sacar tornillos y tuercas dañados u oxidados.

Contenido:

4 Vasos de impacto de 3/8" para tornillos dañados:
8; 10; 12; 13mm

6 Vasos de impacto de 1/2" para tornillos dañados:
14; 15; 16; 17; 19; 21mm

20/15.5/16.5/0.9' 775g

Kit de reparación de roscas de 130 pzs.

9130U1



Contenido:

• Insertos de acero inoxidable:
25 de M5-0.8 x 1.5D, 25 de M6-1.0 x 1.5D, 25 de M8-1.25 x 1.5D, 25 de M10-1.5 x 1.5D, 10 de M12-1.75 x 1.5D.

• Machos de acero rápido:
1 de M5-0.8, 1 de M6-1.0, 1 de M8-1.25, 1 de M10-1.5, 1 de M12-1.75.

• Barrenas de acero carbon:
1 de M5-0.8, 1 de M6-1.0, 1 de M8-1.25, 1 de M10-1.5, 1 de M12-1.75.

• Brocas de acero rápido:
1 de 5.2mm, 1 de 6.3mm, 1 de 8.3mm, 1 de 10.4mm, 1 de 12.4mm.

• Utiles de acero:
1 de M5-0.8, 1 de M6-1.0, 1 de M8-1.25, 1 de M10-1.5, 1 de M12-1.75.

8/19.5/20.5/1.2' 2437g

Lima para roscas exteriores métricas

66901



66901 Contenido:

Lima métrica / Pasos: 0.75; 1.00; 1.25; 1.50;
1.75; 2.00; 2.50; 3.00

72/15.0/16.0/1.2' 208g



Limas para roscas exteriores e interiores métricas y SAE

9U1101 / 9U1102

- Para repar roscas exteriores e interiores



9U1101

Pasos métricos :0.80-1.00-1.25-1.50-1.75-2.00-2.50-3.00

9U1102

Pasos SAE : 24-20-18-16-14-12-11-10

120/19.7/20.7/1.7' 164g

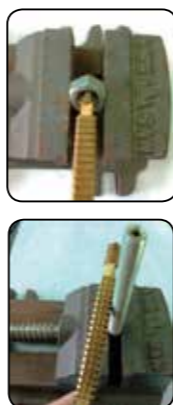

Juego de 20 galgas de espesores métricas

618		l	
Ref.	100/10.4/11.4/1.1'	105mm	104g

20 Galgas de 0.05 a 1.00mm



Punta de trazar de tungsteno

87901	l	
Ref.	mm	g
87901	145	20



Juego de 9 galgas SAE y métricas inclinadas

61803		l	
Ref.	100/10.4/11.4/1.4'	100mm	104g

*Medidas: 0.009"-0.015"-0.016"-0.017"-0.018"
0.019"-0.020"-0.021"-0.026"

*Con medida métrica y SAE en cada galga
*Hojas de 100x13mm

Pistolas de soplar

9U0202 / 9U0203



9U0202

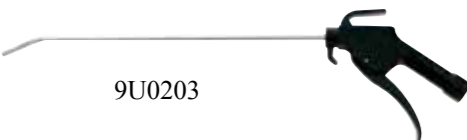

9U0203

Especificaciones:

- Largo: 100mm (9U0202) / 175mm (9U0203)
- Presión de trabajo: 78~120 PSI / 5~8 KGS
- Entrada de aire: 1/4"

9U0202 60/10/11/1.6' 167g
9U0203 50/12/13.5/2.9' 240g

Termómetro de infrarrojos

9U0401



- Punto láser de referencia.
- Mide en °C y °F
- Rango de medida: -20 a 500°C
- Operativo a temperaturas de 0 a 50°C
- Temperatura de almacenamiento: -20 a 50°C
- Precisión: ±2.5% o 3°C
- Distancia al punto: 10:1
- Pila incluida de 9V

20/3.5/4.5/2' 175g

Lupa de trabajo con 14 LED

68610



- LED de luz blanca.
- Lente de 3 x aumentos.
- Diámetro de la lupa de 100mm.
- Puede usar 2 pilas AAA o enchufarse a la red con el transformador que la acompaña.
- Base magnética.
- Pilas: AAA x 2 (1.5V/cada una).
Transformador (Input : AC100V / AC240V ; Output : DC4.5V)

20/18.5/20.0/2.7' 925g



Comprobador de tension sin contacto

88407		l	
Ref.	100/5.1/6.1/1.3'	160mm	51g

Rango de comprobación: 12-600V AC



Comprobador de tension universal

88408		l	
Ref.	60/9.7/10.7/2.7'	210mm	162g

Rango de comprobación: 12-400V AC



Rompetuercas

672	Capacidad
6721622	5/8" a 7/8" / 16 a 22mm
6722227	7/8" a 1.1/8" / 22 a 27mm



Imantador / Desimantador

88601	Tamaño	Envase	g
88601	5cmx5cmx3cm	120/16.6/17.6/1.3'	140



Bandeja magnética rectangular de 3 imanes

88003		
Ref.	12/15.0/16.0/1.4'	1250g

Largo: 360mm ; Ancho: 160mm
 Con 3 imanes de alta potencia recubiertos de goma para no dañar superficies.
 Construida en acero inoxidable
 Se puede usar en horizontal, verical, etc.



Bandeja magnética cuadrada de 4 imanes

88004		
Ref.	6/8.5/9.5/1.42'	1420g

Largo: 293mm ; Ancho: 270mm
 Imanes de alta potencia recubiertos de goma para no dañar superficies.
 Construida en acero inoxidable
 Se puede usar en horizontal, verical, etc.



Bandeja magnética rectangular de 2 imanes

88002		
Ref.	20/14.7/15.7/2.28'	735g

Largo: 242mm ; Ancho: 132mm
 Con dos imanes de alta potencia recubiertos de goma para no dañar superficies.
 Construida en acero inoxidable
 Se puede usar en horizontal, verical, etc.



Imán retráctil con luz, espejo y punta

617			
Ref.	100/8.2/9.2/1.1'	235mm	82g

Extensible hasta 63cm
 Con imán para recoger objetos ferrosos.
 Con espejo ajustable en múltiples posiciones.
 Con punta de trazar cubierta en un extremo



Imán flexible con espejo y luz

617L		
Ref.	72/15.1/16.1/2'	210g

Interruptor de encendido para la luz
 Imán recogedor de 1,6Kg
 Cuello flexible de 455 x 8.5mm
 Espejo oval de 25 x 50mm
 Bombilla de 2.2V 0,25A
 Usa 2 pilas AA no incluidas



Dedo magético ligero

61702		
Ref.	72/11.0/12.0/1.8'	150g

Longitud: 400mm y diámetro 5mm
 Cuello flexible y empuñadura PVC
 Capacidad magnetica de 0.7Kg
 Longitud total de 510mm

Recogedor magnético con liberador rápido

88013



- 400mm
- Capacidad: 6.36 kg



- Recoge de forma rápida y eficaz todo tipo de restos de hierro. Especialmente útil para virutas de hierro y otros restos de corte ya que los elimina en su totalidad y sin riesgo de accidentes para el usuario.

20/12.8/13.8/2.9'	640g
-------------------	------



Pinza recogedora de 3 garras

88901		
Ref.	150/15.1/16.1/1.2'	100g

Longitud: 560mm



Dedo magético de alta potencia

61701		
Ref.	100/19.0/20.0/1.9'	190g

Longitud: 440mm y diámetro 8.5mm
 Cuello flexible y empuñadura PVC
 Capacidad magnetica de 1.6Kg
 Longitud total de 535mm

Manta magnética con bolsillos

88804

Medidas: 108cmx39cm

- No daña la pintura en la zona donde se apoya
- Fácil de plegar. Los imanes se pueden sacar para lavarla. Con varios bolsillos para poner herramientas.



18/11.9/12.9/4' 660g

Camilla deslizante

9U0311

- 6 Ruedas giratorias,
- La almohada se puede quitar.
- Medidas: 93x50x12 cm



1/8.0/9.0/1.8' 8kg

Embudo metálico flexible

887D01

- Embudo de acero galvanizado con cuello largo maleable.
- Muy útil para accesos difíciles
- Largo del tubo: 370 mm



10/3.4/4.4/2.6' 340g

Juego de 4 palancas desmontadoras con garra y punta

904U6

- 904U606 - 150mm
- 904U612 - 300mm
- 904U616 - 400mm
- 904U620 - 500mm



1700g

Palancas Jumbo

687



Ref.	Largo mm	Peso
687780	780	1085 g
687910	910	1830 g
687910A	910	1830 g

Palancas desmontadoras extensibles

68790 / 68755



- Para reparaciones en vehículos y maquinaria.
- Ocupa poco espacio.
- Fácil de transportar y guardar.



Ref.	Diámetro	Plegada	Extendida	Peso(kg)	Fuerza (kgf.m)	Embalaje
68790	16 mm Hex	65.5 cm	90.5 cm	2.0	50	8/16.0/16.8/1.0
68755	13 mm Hex	42.0 cm	55.5 cm	0.9	35	20/18.0/19.0/0.6

Palancas desmontadoras con mango

904U5



- Tamaños: 200mm, 300mm, 450mm y 600mm.

12/17.0/18.0/1.5' 1420g

Juego de palancas Jumbo

904U2



- Extra largas y fuertes para usar con las dos manos.
- Empuñaduras ergonómicas bicomponente
- Construidas en Cromo Molibdeno
- Templadas y endurecidas
- 16mm de grosor
- Medidas: 600mm x 70°; 600mm x 90°; 900mm x 35°; 900mm recta

2/17.5/18.5/1.4' 8730g



Juego de 4 destornilladores torx

2044			
Ref.	Torx	60/9.0/10.0/2.5'	150g
716185 06...09	Contenido: 4-Destornilladores Torx: T6; T7; T8; T9 (Varilla de 100mm)		



Juego de 6 destornilladores torx

2061			
Ref.	Torx	30/12.5/13.5/2.2'	415g
716 10...30	Contenido: 6-Destornilladores Torx: T10; T15; T20; T25; T27; T30		

NEW



Juego de 7 destornilladores torx de 300mm

20719			
Ref.	Tip	10/10.3/11.3/1.3'	1030g
716300 10..40	Contenido: 7-Destornilladores Torx de 300mm: T10; T15; T20; T25; T27; T30; T40		



Juego de 8 destornilladores torx

2086			
Ref.	Torx	10/6.0/7.0/1.1'	600g
716 08...40	Contenido: 8-Destornilladores Torx: T8; T10; T15; T20; T25; T27; T30; T40		



Juego de 11 destornilladores torx inviolable

2119T			
Ref.	Torx H	20/18.0/19.0/2.3'	900g
717 06...40	Contenido: 11-Destornilladores Torx inviolable T-6H; T-7H; T-8H; T-9H; T-10H; T-15H; T-20H; T-25H; T-27H; T-30H; T-40H		

NEW



Juego de 6 destornilladores

2068		
Ref.	10/10/11/1.2'	1000g
713 03...065	Contenido: 4-Destornilladores planos 3mm(75mm); 4mm(100mm); 5.5mm(125mm); 6.5mm(150mm) 2-Destornilladores Phillips PH.1(80mm); PH.2(100mm)	
711 1, 2		

NEW



Juego de 6 destornilladores largos

20611		
Ref.	10/10/11/1.2'	1000g
6553 04...12	Contenido: 4-Desornilladores planos largos 4mm(300mm); 5mm(300mmL); 6mm(300mmL); 8mm(300mmL) 2-Destornilladores Phillips largos PH.1(350mm); PH.2(350mm)	
655..11..08		



Juego de 8 destornilladores

2085		
Ref.	10/4.6/5.6/1.1'	460g
713055S	Contenido: 2-Destornilladores planos 5.5 mm (25mm)	
713065S	6.5 mm (25mm)	
7110	2-Destornilladores Phillips PH.0 (60mm)	
7111S	PH.1 (25mm)	
7120	4-Destornilladores Pozidriv PZ.0 (60mm)	
7121S	PZ.1 (25mm)	
7121	PZ.1 (80mm)	
7122	PZ.2 (100mm)	



Juego de 8 destornilladores

2084		
Ref.	10/6.8/7.8/1.1'	680g
71303	Contenido: 6-Destornilladores planos 3 mm (75mm)	
713035	3.5 mm (100mm)	
71304	4 mm (100mm)	
713055	5.5 mm (125mm)	
713065	6.5 mm (150mm)	
71308	8 mm (175mm)	
7111	2-Destornilladores Phillips PH.1 (80mm)	
7112	PH.2 (100mm)	



Juego de 10 destornilladores martillables

2108		
Ref.	6/14.4/15.4/1.3'	2400g
713 055M...14M	Contenido: 6-Destornilladores planos martillables 5.5(125mm); 6.5(150mm); 8(150mm); 10(200mm); 12(200mm); 14(250mm)	
711 1M...4M	4-Destornilladores Phillips martillables PH.1(80mm); PH.2(100mm); PH.3(150mm); PH.4(200mm)	



Juego de 14 destornilladores

2142		
Ref.	6/8.4/9.4/1.3'	1400g
713 03...08	Contenido: 6-Destornilladores planos 3mm(75mm); 3.5mm(100mm); 4mm(100mm); 5.5mm(125mm); 6.5mm(150mm); 8mm(175mm)	
713 055S...065S	2-Destornilladores planos cortos 5.5mm(25mm); 6.5mm(25mm)	
711 0...3	4-Destornilladores Phillips PH.0(60mm); PH.1(80mm); PH.2(100mm); PH.3(150mm)	
711 1S...2S	2-Destornilladores Phillips cortos PH.1(25mm); PH.2(25mm)	



Juego de 8 destornilladores de precisión

2087		
Ref.	40/13.6/14.6/1.6'	340g
733075 02...04	Contenido: 5-Destornilladores planos de precisión 2.0; 2.5; 3.0; 3.5; 4.0 (75mm)	
731075 00...1	3-Destornilladores Phillips de precisión PH.00; PH.0; PH.1 (75mm)	



Juego de 8 destornilladores de precisión Torx

2088			
Ref.	Torx	40/13.6/14.6/1.6'	340g
736040 05...08	Contenido: 8-Destornilladores torx de precisión T5; T6; T7; T8 (40mm)		
736075 09...20	T9; T10; T15; T20 (75mm)		



Juego de 10 herramientas de precisión

2106A		
Ref.	20/13.5/14.5/2.4'	675g
733A040	5 Destornilladores planos: 1.2; 1.5; 1.8; 2 y 2.5mm	
731A040	3 Destornilladores Phillips: Ph000, Ph00 y Ph0	
610110	Mini alicate de punta	
612140	Mini alicate de corte	
6945140	Pinza de precisión	

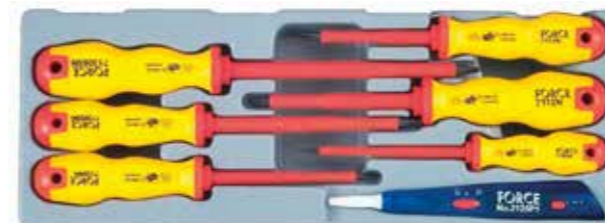

Juego de 7 destornilladores 1000V

20712		
Ref.	10/6.4/7.4/1.1'	640g
711 1N...2N	Contenido: 2-Destornilladores Phillips 1000V PH.1 (80mm); PH.2 (100mm)	
713 03N...065N	4-Destornilladores planos 1000V 3 (100mm); 4 (100mm); 5.5 (125mm); 6.5 (150mm)	
2125P1	1-Comprobador de corriente	



Juego de 13 destornilladores de tubo

2134			
Ref.	Vaso	6/11.0/12.0/1.3'	1833g
744250 04...14	Contenido: 13-Llaves de tubo con mango 4; 4.5; 5; 5.5; 6; 7; 8; 9; 10; 11; 12; 13; 14mm (250mm)		



Juego de 12 destornilladores 1000V

2125		
Ref.	6/7.0/8.0/1.3'	1160g
713 024N...8N	Contenido: 7-Destornilladores planos 1000V 2.5(75mm); 3(100mm); 3.5(100mm); 4(100mm); 5.5(125mm); 6.5(150mm); 8(175mm)	
711 0N...3N	4-Destornilladores Phillips 1000V PH.0(60mm); PH.1(80mm); PH.2(100mm); PH.3(150mm)	
2125P1	1-Comprobador de corriente	



Juego de 9 llaves allen mango T

2097			
Ref.	Allen	6/7.0/8.0/1.3'	1166g
724 02...10	Contenido: 9-Llaves allen mango T 2; 2.5; 3; 4; 5; 6; 7; 8; 10mm		



Juego de 14 llaves Torx mango T

2141			
Ref.	Torx	6/8.5/9.5/2.4'	1415g
726 06...55	Contenido: 14- Llaves Torx mango T T6; T7; T8; T9; T10; T15; T20; T25; T27; T30; T40; T45; T50; T55		

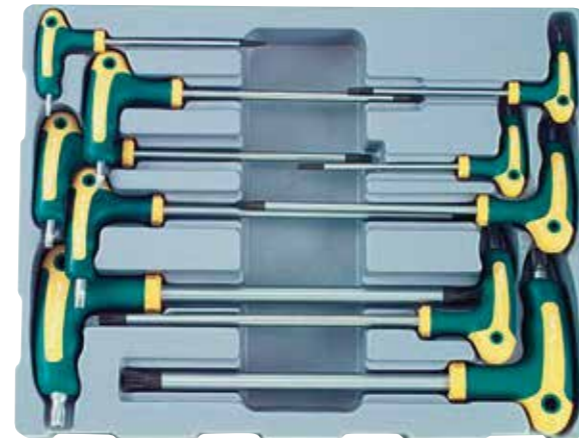

Juego de 10 llaves Torx inviolable bicomponente

51010T			
Ref.	Torx	6/7.8/8.8/1.3'	1300g
767 10G...55G	Contenido: 10-Llaves torx inviolable bicomponente T10xT-10H; T15xT-15H; T20xT-20H; T25xT-25H; T27xT-27H; T30xT-30H; T40xT-40H; T45xT-45H; T50xT-50H; T55xT-55H		



Juego de 9 llaves de vaso mango T

2095			
Ref.	Vaso	6/11.3/12.3/2.4'	1880g
774300 05...13	Contenido: 9- Llaves de vaso mango T 5; 6; 7; 8; 9; 10; 11; 12; 13mm (300mm)		

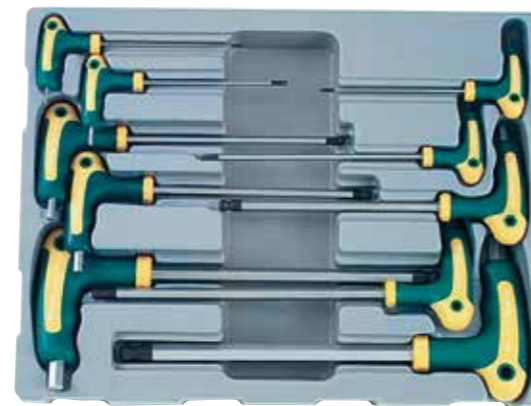

Juego de 10 llaves allen bicomponente

5106B			
Ref.		6/9.3/10.3/1.3'	1550g
765 02G...12G	Contenido: 10-Llaves allen bicomponente bola 2; 2.5; 3; 4; 5; 6; 7; 8; 10; 12 mm		

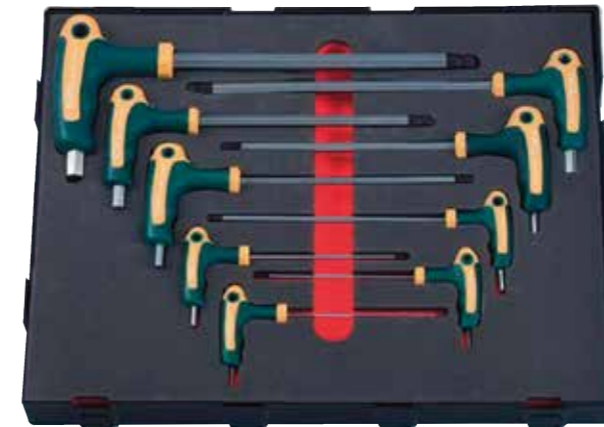

Juego de 9 llaves allen bicomponente SAE

K50916S			
Ref.	Allen	6/7.0/8.0/1.3'	1772g
765 5.64G...1.2G	Contenido: 9-Llaves allen mango bicomponente SAE 5/64"; 3/32"; 1/8"; 5/32"; 3/16"; 1/4"; 5/16"; 3/8"; 1/2"		

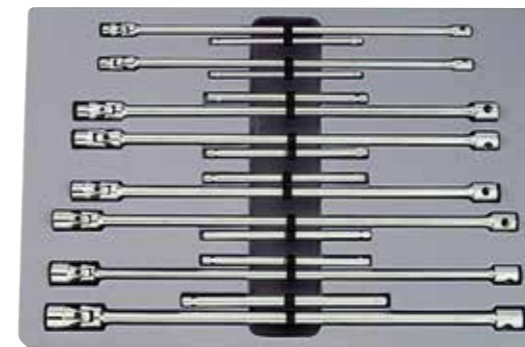

Juego de 8 llaves de vaso articuladas T

50816		
Ref.	6/24.2/25.2/2.8'	4030g
7842 07U...08U 7843 10U...17U 7844 19U	Contenido: 8- Llaves de vaso articuladas largas 1/4": 7 y 8 mm 3/8": 10; 12; 13; 14; 17 mm 1/2": 19 mm	



Juego de 6 llaves para racores métricas

5066		
Ref.	30/20.5/21.5/1.3'	610g
751 0810...1719	Contenido: 6-Llaves para racores 8x10; 10x11; 10x12; 11x13; 12x14; 17x19 mm	



Juego de 8 llaves para racores métricas

5082		
Part no.	6/14.5/15.5/0.9'	2415g
751 0810...3032	Contenido: 8-Llaves para racores 8x10; 11x13; 12x14; 16x18; 17x19; 19x22; 24x27; 30x32 mm	



Juego de llaves de pata de cuervo de 17 pzs.

5172		
Ref.	6/12.9/13.9/0.9'	2150g
7513 10...22	Contenido: 12- Llaves de pata de cuervo de 3/8" 10; 11; 12; 13; 14; 15; 16; 17; 18; 19; 21; 22 mm	
7514 23...26	3- Llaves de pata de cuervo de 1/2" 23; 24; 26 mm	
808306	2- Extensiones con bloqueo 3/8" (150mm)	
808405	1/2" (125mm)	



Juego de 3 llaves de vaso articuladas

5033			
Ref.	6/15.0/16.0/0.9'	2500g	
752 2022...2427	Contenido: 3- Llaves de vaso articuladas poligonales 20x22; 21x23; 24x27 mm		



Juego de 7 llaves de Torx hembra articuladas

5075			
Ref.	Torx E	6/12.5/13.5/0.9'	2080g
756 0405F... 2224F	Contenido: 7- Llaves Torx hembra articuladas E4xE5; E6xE7; E8xE10; E11xE12; E14xE16; E18xE20; E22xE24		



Juego de 6 llaves Torx hembra codo 75°

5065			
Ref.	Torx E	20/13.8/14.8/1.4'	690g
756 0608A... 2024A	Contenido: 6- Llaves Torx hembra acodadas 75° E6xE8; E7xE11; E10xE12; E14xE18; E16xE22; E20xE24		



Juego de llaves pata de cuervo de 13 pzs. SAE

5135S		
Ref.	6/12.0/13.0/0.9'	2000g
7513 3.8...7.8	Contenido: 9- Llaves de pata de cuervo de 3/8" 3/8"; 7/16"; 1/2"; 9/16"; 5/8"; 11/16"; 3/4"; 13/16"; 7/8"	
7514 15.16...1.0	2- Llaves de pata de cuervo de 1/2" 15/16"; 1"	
808306	2- Extensiones con bloqueo 3/8" (150mm)	
808405	1/2" (125mm)	



Juego de 7 llaves de vaso articuladas

5074			
Ref.	6/13.0/14.0/0.9'	2165g	
752 0607... 1819	Contenido: 7- Llaves de vaso articuladas poligonales 6x7; 8x9; 10x11; 12x13; 14x15; 16x17; 18x19 mm		



Juego de 6 llaves Torx hembra planas

5062			
Ref.	Torx E	30/17.0/18.0/1.4'	515g
756 0608...2024	Contenido: 6- Llaves Torx hembra planas E6xE8; E7xE11; E10xE12; E14xE18; E16xE22; E20xE24		

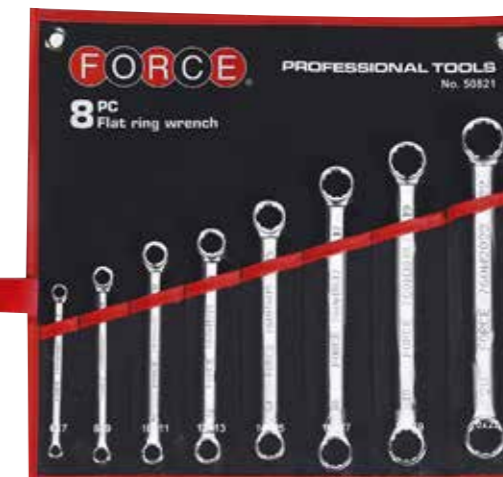

Juego de 8 llaves de estrella planas en bolsa

50821		
Ref.	10/8.0/9.0/0.69'	800g
760M 0607...2022	Contenido: 8- Llaves de estrella planas 6x7; 8x9; 10x11; 12x13; 14x15; 16x17; 18x19; 20x22;	



Juego de 12 llaves de estrella planas

T51226			
Ref.	6/14.0/15.0/0.73'	2333g	

760M 0607...3032
 Contenido:
 12-Llaves de estrella planas
 6x7; 8x9; 10x11; 12x13; 14x15; 16x17;
 18x19; 20x22; 21x23; 22x24; 26x28;
 30x32 mm



Juego de 6 llaves de estrella planas largas

50622			
Ref.	12/23.8/24.8/1.2'	1980g	

760 1012...1719
 Contenido:
 6-Llaves estrella plana largas
 10x12; 12x14; 13x15; 14x17;
 16x18; 17x19 mm



Juego de 6 llaves estrella plana carraca

K50625			
Part no.	6/15.5/16.5/0.8'	2580g	

827M 0809...
 1719
 Contenido:
 6-Llaves estrella plana carraca
 8x9; 10x11; 12x13; 14x15;
 16x18; 17x19



Juego de 4 llaves Torx hembra carraca

K50411			
Ref.	Torx E 12/15.0/16.0/1.1'	1250g	

828 0608...2024
 Contenido:
 4-Llaves Torx hembra carraca
 E6xE8; E10xE12; E14xE18;
 E20xE24



Juego de 8 llaves fijas planas en estuche

K5084		
Ref.	6/14.0/15.0/0.73'	1050g

7540607...2022
 Contenido:
 8-Llaves fijas planas
 6x7; 8x9; 10x11; 12x13; 14x15; 16x17;
 18x19; 20x22



Juego de 10 llaves fijas planas en estuche

K51019		
Ref.	6/14.0/15.0/0.73'	2000g

7540607...2426
 Contenido:
 10-Llaves fijas planas
 6x7; 8x9; 10x11; 12x13; 14x15; 16x17;
 18x19; 20x22; 21x23; 24x26



Juego de 12 llaves fijas planas en estuche

K5128-26		
Ref.	6/14.0/15.0/0.73'	2600g

7540607...3032
 Contenido:
 12-Llaves fijas planas
 6x7; 8x9; 10x11; 12x13; 14x15; 16x17;
 18x19; 20x22; 21x23; 24x26; 25x28;
 30x32



Juego de 8 llaves fijas planas en caja

5084K		
Ref.	10/9.6/10.6/0.88'	960g

754 0607...
 2022
 Contenido:
 8-Llaves fijas planas
 6x7; 8x9; 10x11; 12x13; 14x15;
 16x17; 18x19; 20x22 mm



Juego de 10 llaves fijas planas en caja

51019K		
Ref.	10/9.6/10.6/0.88'	2000g

754 0607...
 2426
 Contenido:
 10-Llaves fijas planas
 6x7; 8x9; 10x11; 12x13; 14x15;
 16x17; 18x19; 20x22; 21x23; 24x26



Juego de 12 llaves fijas planas en caja

5128K-26		
Ref.	10/9.6/10.6/0.88'	2500g

754 0607...
 3032
 Contenido:
 12-Llaves fijas planas
 6x7; 8x9; 10x11; 12x13; 14x15;
 16x17; 18x19; 20x22; 21x23;
 24x26; 25x28; 30x32mm



Juego de 12 llaves combinadas cortas

51214P		
Ref.	20/20.5/21.5/1.3'	1025g
755S 08...19	Contenido: 12-Llaves combinadas cortas 8; 9; 10; 11; 12; 13; 14; 15; 16; 17; 18; 19 mm	



Juego de 10 llaves combinadas en estuche

K51018		
Ref.	6/14.0/15.0/0.73'	2000g
75508...22	Contenido: 10-Llaves combinadas 8; 10; 11; 12; 13; 14; 15; 17; 19; 22	



Juego de 8 llaves combinadas en estuche

K5086		
Ref.	6/14.0/15.0/0.73'	1000g
75510...22	Contenido: 10-Llaves combinadas 10; 11; 12; 13; 14; 17; 19; 22	

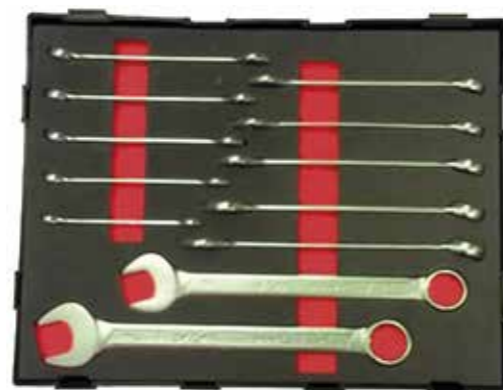

Juego de 12 llaves combinadas en estuche

K5121-24		
Ref.	6/14.0/15.0/0.73'	2700g
75508...24	Contenido: 12-Llaves combinadas 8; 10; 11; 12; 13; 14; 15; 16; 17; 19; 22; 24	

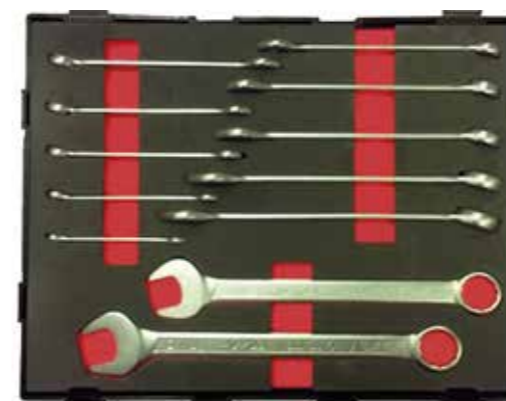

Juego de 12 llaves combinadas en estuche SAE

K5121S		
Ref.	6/14.0/15.0/0.73'	2700g
7551.4...15.16	Contenido: 10-Llaves combinadas SAE 1/4; 5/16; 3/8; 7/16; 1/2; 9/16; 5/8; 11/16 3/4; 13/16; 7/8; 15/16	



Juego de 8 llaves combinadas en caja

5086K		
Ref.	20/17.3/18.3/1.1'	1000g
755 10...22	Contenido: 8-Llaves combinadas 10; 11; 12; 13; 14; 17; 19; 22 mm	



Juego de 10 llaves combinadas en caja

51018K		
Ref.	20/17.3/18.3/1.1'	2000g
755 08...22	Contenido: 10-Llaves combinadas 8; 10; 11; 12; 13; 14; 15; 17; 19; 22	



Juego de 12 llaves combinadas en caja

5121K-24		
Ref.	20/17.3/18.3/1.1'	2700g
755 08...24	Contenido: 12- Llaves combinadas 8; 10; 11; 12; 13; 14; 15; 16; 17; 19; 22; 24	



Juego de 12 llaves combinadas en caja SAE

5121SK		
Ref.	20/17.3/18.3/1.1'	2700g
7551.4...15.16	Contenido: 12-Llaves combinadas SAE 1/4; 5/16; 3/8; 7/16; 1/2; 9/16; 5/8; 11/16 3/4; 13/16; 7/8; 15/16	



Juego de 19 llaves combinadas en bolsa

5191		
Ref.	10/24.5/25.5/1.2'	2450g
755 06...24	Contenido: 19- Llaves combinadas 6; 7; 8; 9; 10; 11; 12; 13; 14; 15; 16; 17; 18; 19; 20; 21; 22; 23; 24 mm	



Juego de 26 llaves combinadas en bolsa

5261P		
Ref.	3/16.6/17.6/1'	5533g
755 06...32	Contenido: 26-Llaves combinadas 6; 7; 8; 9; 10; 11; 12; 13; 14; 15; 16; 17; 18; 19; 20; 21; 22; 23; 24; 25; 26; 27; 28; 29; 30; 32 mm	

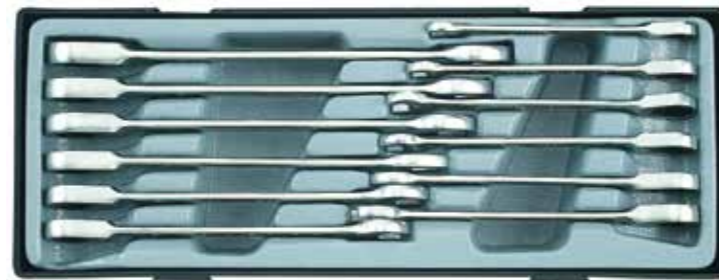

Juego de 12 llaves combinadas con carraca

51210		
Ref.	6/12.8/13.8/0.9'	2130g
757 08...19	Contenido: 12-Llaves combinadas con carraca 8; 9; 10; 11; 12; 13; 14; 15; 16; 17; 18; 19 mm	



Juego de 12 llaves combinadas carraca mini

K51216		
Ref.	6/8.8/9.8/0.8'	1466g
757S 08...19	Contenido: 12-Llaves combinadas carraca cortas 8; 9; 10; 11; 12; 13; 14; 15; 16; 17; 18; 19 mm	



Juego de 12 llaves combinadas con carraca articuladas

K51210F		
Ref.	6/14.4/15.4/1.5'	2400g
757 08F...19F	Contenido: 12-Llaves combinadas con carraca articuladas 8; 9; 10; 11; 12; 13; 14; 15; 16; 17; 18; 19 mm	

NEW



Juego de 12 llaves combinadas carraca articulada SAE

K51225		
Ref.	6/23.4/24.4/1.5'	3900g
757 5.16F...1.0F	Contenido: 12-Llaves combinadas con carraca articuladas 5/16"; 3/8"; 7/16"; 1/2"; 9/16"; 5/8"; 11/16"; 3/4"; 13/16"; 7/8"; 15/16"; 1"	



Juego de 10 llaves estrella acodada 75° en estuche

K51017			
Ref.		6/12.4/13.4/0.9'	3000g
759 0607...2426	Contenido: 10-Llaves estrella acodada 75° 6x7; 8x9; 10x11; 12x13; 14x15; 16x17; 18x19; 20x22; 21x23; 24x26		



Juego de 8 llaves estrella acodada 75° en estuche

K5081-20			
Ref.		6/12.4/13.4/0.9'	2066g
759 0607...2022	Contenido: 8-Llaves estrella acodada 75° 6x7; 8x9; 10x11; 12x13; 14x15; 16x17; 18x19; 20x22 mm		



Juego de 12 llaves estrella acodada 75° en estuche

K51213-26			
Ref.		6/12.4/13.4/0.9'	3800g
759 0607...3032	Contenido: 12-Llaves estrella acodada 75° 6x7; 8x9; 10x11; 12x13; 14x15; 16x17; 18x19; 20x22; 21x23; 24x26; 25x28; 30x32		



Juego de 8 llaves estrella acodada 75° en caja

5081K-20			
Ref.		6/12.4/13.4/0.9'	2066g

759 0607...
2022

Contenido:
8-Llaves estrella acodada 75°
6x7; 8x9; 10x11; 12x13; 14x15;
16x17; 18x19; 20x22 mm

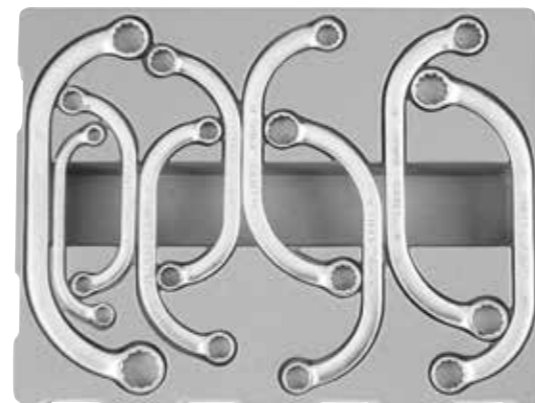

Juego de 9 llaves de media luna

50911			
Ref.		6/8.3/9.8/1.3'	1380g

761 0810...1922

Contenido
9-Llaves de media luna
8x10; 10x12; 11x13; 12x14;
13x15; 14x17; 16x18; 17x19;
19x22 mm



Juego de 10 llaves estrella acodada 75° en caja

51017K			
Ref.		6/12.4/13.4/0.9'	3000g

759 0607...
2426

Contenido:
10-Llaves estrella acodada 75°
6x7; 8x9; 10x11; 12x13; 14x15;
16x17; 18x19; 20x22; 21x23; 24x26

NEW



Juego de llaves de tubo con llave ajustable de trinquete en estuche de 11 pzs.

51113			
Ref.		6/14.7/15.7/1.5'	2463g

649200D.

762 0607..2123

762220

Contenido
1-Llave ajustable de trinquete
11- Llaves de tubo
6x7; 8x9; 10x11; 12x13; 14x15;
16x17; 18x19; 20x22; 21x23;
1-Barra para girar llaves de tubo de 220mm

Juego de 12 llaves estrella acodada 75° en caja

51213K-26			
Ref.		6/12.4/13.4/0.9'	3800g

759 0607...
3032

Contenido:
12-Llaves estrella acodada 75°
6x7; 8x9; 10x11; 12x13; 14x15;
16x17; 18x19; 20x22; 21x23;
24x26; 25x28; 30x32



Juego de 8 llaves te tubo en estuche

K50920			
Ref.		6/14.7/15.7/1.5'	1400g

762 0607..2022

762220

Contenido
8- Llaves de tubo
6x7; 8x9; 10x11; 12x13; 14x15;
16x17; 18x19; 20x22;
1-Barra para girar llaves de tubo de 220mm

NEW



Juego de 12 llaves te tubo en estuche

K5145			
Ref.		6/14.7/15.7/1.5'	5300g

762 0607..2426

762220

Contenido
12- Llaves de tubo
6x7; 8x9; 10x11; 12x13; 14x15; 16x17;
18x19; 20x22; 21X23; 24X26; 25X28;
30X32
2-Barras para girar llaves de tubo



Juego de 10 llaves te tubo en estuche

K51227			
Ref.		6/14.7/15.7/1.5'	3000g

762 0607..2426

762220

Contenido
10- Llaves de tubo
6x7; 8x9; 10x11; 12x13; 14x15;
16x17; 18x19; 20x22; 21X23; 24X26
2-Barras para girar llaves de tubo



Juego de 7 llaves allen

5072			
Ref.		60/16.2/17.2/1.1'	270g

764 025...10

Contenido:
7-Llaves allen
2.5; 3; 4; 5; 6; 8; 10 mm



Juego de 7 llaves allen largas de bola

5072XLB				
Ref.			40/18.2/19.2/1.1'	455g
765 025XL... 10XL	Contenido: 7-Llaves allen largas de bola 2.5; 3; 4; 5; 6; 8; 10 mm			

Juego de 7 llaves allen largas de bola SAE

5072XLS				
Ref.			40/17.5/18.5/1.1'	438g
765 3.32XL... 3.8XL	Contenido: 7-Llaves allen largas de bola 3/32"; 1/8"; 5/32"; 3/16"; 1/4"; 5/16"; 3/8"			



Juego de 9 llaves allen largas de bola SAE

5093LBS				
Part no.			60/22.8/23.8/1.9'	380g
765 1.16L... 3.8L	Contenido: 9-Llaves allen largas de bola 1/16"; 5/64"; 3/32"; 1/8"; 5/32"; 3/16"; 1/4"; 5/16"; 3/8"			



Juego de 10 llaves allen SAE

5109S			
Ref.		60/27.0/28.0/2.2	450g
764 1.16...1.2	Contenido: 10-Llaves allen 1/16"; 5/64"; 3/32"; 1/8"; 5/32"; 3/16"; 1/4"; 5/16"; 3/8"; 1/2"		



Juego de 10 llaves allen de bola

5102LB				
Part no.			50/19.4/20.4/2.2'	386g
765 0127L... 10L	Contenido: 10-Llaves allen de bola 1.27; 1.5; 2; 2.5; 3; 4; 5; 6; 8; 10 mm			

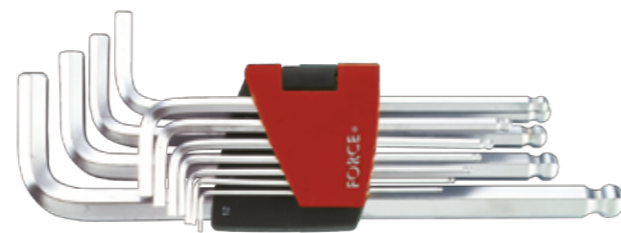

Juego de 11 llaves allen de bola

5116LB				
Part no.			30/21.8/22.8/1.58'	726g
765 015L...12L	Contenido: 11-Llaves allen de bola 1.5; 2; 2.5; 3; 4; 5; 6; 7; 8; 10; 12 mm			



Juego de 13 llaves allen (MM)

5137			
Ref.		12/23.4/24.4/1.3'	1950g
764 02...19	Contenido: 13-Llaves allen 2; 2.5; 3; 4; 5; 6; 7; 8; 10; 12; 14; 17; 19 mm		

Juego de 13 llaves allen (SAE)

5137S			
Ref.		12/23.4/24.4/1.3'	1950g
764 1.16...3.4	Contenido: 13-Llaves allen 1/16"; 5/64"; 3/32"; 1/8"; 5/32"; 3/16"; 1/4"; 5/16"; 3/8"; 1/2"; 9/16"; 5/8"; 3/4"		



Juego de 9 llaves Torx largas

5098L			
Ref.		50/16.5/17.5/1.8'	870g
766 10L...50L	Contenido: 9-Llaves Torx largas T10; T15; T20; T25; T27; T30; T40; T45; T50		

Juego de 9 llaves Torx Inviolable largas

5098LT			
Ref.		50/16.5/17.5/1.8'	870g
767 10L...50L	Contenido: 9-Llaves Torx Inviolable largas T-10H; T-15H; T-20H; T-25H; T-27H; T-30H; T-40H; T-45H; T-50H		



Juego de 9 llaves Torx largas en bolsa

5099L			
Ref.		30/22.0/23.0/0.7'	733g
766 20L...60L	Contenido: 9-Llaves Torx largas T20; T25; T27; T30; T40; T45; T50; T55; T60		



Destornillador Phillips mango bicomponente

711					
Ref.	Punta	Varilla	Total	g	ud/caja
7111S	PH.1	25	75	39	10
7112S	PH.2	25	75	42	10
7110	PH.0	60	145	33	10
7111	PH.1	80	185	79	10
7112	PH.2	100	215	11	10



Destornillador Phillips mango bicomponente varilla hexagonal

7113					
Ref.	Punta	Varilla	Total	g	ud/caja
7113	PH.3	150	275	226	10



Destornillador plano martillable

713..M					
Ref.	Punta	Varilla	Total	g	ud/caja
71310M	10	200	325	327	10
71312M	12	200	325	329	10
71314M	14	250	375	364	10



Destornillador plano mango bicomponente

713					
Ref.	Punta	Varilla	Total	g	ud/caja
71305S	1.0 x 5.5	25	75	36	10
71306S	1.2 x 6.5	25	75	40	10
71303	0.5 x 3	75	160	31	10
713035	0.5 x 3.5	100	185	35	10
71304	0.8 x 4	100	205	58	10
713055	1.0 x 5.5	125	230	65	10
713065	1.2 x 6.5	150	265	132	10

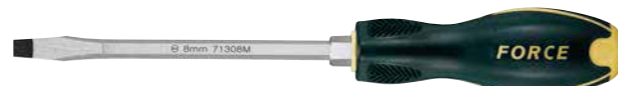

Destornillador plano varilla hexagonal

71308					
Ref.	Punta	Varilla	Total	g	ud/caja
71308	5.5	125	230	103	10



Destornillador Torx Inviolable

717					
Ref.	Punta	Varilla	Total	g	ud/caja
71705	T-5H	60	145	31	10
71706	T-6H	60	145	31	10
71707	T-7H	60	145	33	10
71708	T-8H	60	145	33	10
71709	T-9H	60	145	32	10
71710	T-10H	80	185	62	10
71715	T-15H	80	185	62	10
71720	T-20H	100	205	64	10
71725	T-25H	100	205	73	10
71727	T-27H	115	230	106	10
71730	T-30H	115	230	107	10
71740	T-40H	130	245	151	10
71745	T-45H	130	255	168	10



Destornillador Phillips extra largo

6551					
Ref.	Punta	Varilla	Total	g	ud/caja
65512	PH.2	350	450	75	5



Destornillador Plano extra largo

6553					
Ref.	Punta	Varilla	Total	g	ud/caja
655304	4	300	400	65	10
655305	5	300	400	65	10
655306	6	300	400	65	10
655308	8	300	400	70	5



Destornillador de vaso flexible

648					
Ref.	Punta	Varilla	Total	g	ud/caja
64806	6	160	270	192	60/2.5'
64807	7	160	270	196	60/2.5'
64808	8	160	270	198	60/2.5'



Destornillador de vaso flexible largo

648...L					
Ref.	Punta	Varilla	Total	g	ud/caja
64806L	6	500	630	275	60/2.4'
64807L	7	500	630	275	60/2.4'
64808L	8	500	630	275	60/2.4'



Llave alen de bola bicomponente

765..G					
Ref.	Punta	larga	corta	g	ud/caja
76502G	2	126	53	15	10
765025G	2.5	126	53	18	10
76503G	3	126	53	21	10
76504G	4	183	68	34	10
76505G	5	183	68	72	10
76506G	6	240	82	90	10
76507G	7	240	82	110	10
76508G	8	240	82	154	10
76510G	10	240	82	275	10
76512G	12	240	82	369	10



Llave Torx inviolable bicomponente

767..G					
Ref.	Punta	larga	corta	g	ud/caja
76710G	T10xT-10H	53	126	27	10
76715G	T15xT-15H	53	126	27	10
76720G	T20xT-20H	68	126	27	10
76725G	T25xT-25H	68	133	84	10
76727G	T27xT-27H	68	133	84	10
76730G	T30xT-30H	82	190	85	10
76740G	T40xT-40H	82	190	144	10
76745G	T45xT-45H	82	190	144	10
76750G	T50xT-50H	82	190	334	10
76755G	T55xT-55H	82	190	340	10



Llave de tubo con mango T

774		<i>l</i>	<i>l</i>		
Ref.	Punta	Varilla	Total	g	ud/caja
77430005	5	260	300	122	10
774300055	5.5	260	300	127	10
77430006	6	260	300	130	10
77430007	7	260	300	133	10
77430008	8	260	300	137	10
77430009	9	260	300	139	10
77430010	10	260	300	202	10
77430011	11	260	300	202	10
77430012	12	260	300	204	10
77430013	13	260	300	224	10



Llaves para racores métricas

751	<i>l</i>			
Ref.	Medidas	mm	g	ud/caja
7510810	8x10	145	50	10
7510911	9x11	150	55	10
7511011	10x11	152	64	10
7511113	11x13	165	86	10
7511214	12x14	178	116	10
7511314	13x14	178	95	10
7511417	14x17	196	174	10
7511618	16x18	210	198	10
7511719	17x19	210	193	10
7511722	17x22	230	244	5
7511819	18x19	210	183	5
7511922	19x22	233	259	5



Llave de vaso articulada

752		<i>l</i>		
Ref.	Medidas	mm	g	ud/caja
7520607	6x7	198	97	10
7520809	8x9	198	99	10
7521011	10x11	213	125	10
7521012	10x12	213	128	10
7521213	12x13	227	161	10
7521415	14x15	243	234	5
7521617	16x17	253	313	5
7521819	18x19	277	382	5
7522022	20x22	292	520	5



Llave de estrella plana

760M		<i>l</i>		
Ref.	Medidas	mm	g	ud/caja
760M0607	6x7	120	23	10
760M0809	8x9	135	31	10
760M1011	10x11	153	48	10
760M1213	12x13	162	64	10
760M1415	14x15	180	92	10
760M1617	16x17	210	118	10
760M1819	18x19	225	146	10
760M2022	20x22	240	186	10
760M2123	21x23	255	245	5
760M2224	22x24	255	224	5
760M2628	26x28	313	417	5
760M2729	27x29	315	414	5
760M3032	30x32	335	510	5



Llave de estrella plana extra larga

760		<i>l</i>		
Ref.	Medidas	mm	g	ud/caja
7600810	8x10	240	87	10
7601214	12x14	330	200	10
7601315	13x15	360	333	10
7601618	16x18	405	458	10
7601719	17x19	405	447	10
7602224	22x24	440	602	10



Llave de estrella plana con carraca

827M		<i>l</i>		
Ref.	Medidas	mm	g	ud/caja
827M0809	8x9	135	52	10
827M1011	10x11	145	70	10
827M1213	12x13	165	92	10
827M1415	14x15	180	134	10
827M1618	16x18	205	175	10
827M1719	17x19	225	198	10



Llave Torx hembra plana con carraca

828		<i>l</i>		
Ref.	Medidas	mm	g	ud/caja
8280608	E6xE8	129	56	10
8281012	E10xE12	144	75	10
8281418	E14xE18	180	147	10
8282024	E20xE24	225	208	10



Llave Torx hembra acodada 75°

756..A		<i>l</i>		
Ref.	Medidas	mm	g	ud/caja
7560608A	E6xE8	145	34	10
7560711A	E7xE11	155	42	10
7561012A	E10xE12	175	51	10
7561418A	E14xE18	215	112	10
7561622A	E16xE22	235	192	5
7562024A	E20xE24	265	224	5



Llave fija plana de dos bocas

754	<i>l</i>			
Ref.	Medidas	mm	g	ud/caja
7540607	6x7	123	27	10
7540809	8x9	141	42	10
7541011	10x11	157	63	10
7541213	12x13	172	83	10
7541415	14x15	190	106	10
7541617	16x17	205	142	10
7541819	18x19	205	134	10
7542022	20x22	236	223	5
7542123	21x23	246	260	5
7542426	24x26	255	266	5
7542427	24x27	259	318	5
7542528	25x28	279	322	5
7543032	30x32	297	465	5
7543436	34x36	350	730	5
7543641	36x41	380	950	5
7544146	41x46	415	1490	5
7544650	46x50	465	2084	5



Llave combinada MM

755	<i>l</i>			
Ref.	Medida	mm	g	ud/caja
75506	6	106	19	10
75507	7	116	22	10
75508	8	126	26	10
75509	9	136	34	10
75510	10	146	43	10
75511	11	156	49	10
75512	12	166	63	10
75513	13	176	72	10
75514	14	186	88	10
75515	15	196	101	10
75516	16	206	108	10
75517	17	216	128	10
75518	18	226	145	10
75519	19	236	167	5
75520	20	246	191	5
75521	21	256	224	5
75522	22	266	226	5
75523	23	276	261	5
75524	24	286	281	5
75526	26	306	332	5
75527	27	316	363	5
75528	28	326	402	5
75529	29	336	450	5
75530	30	346	512	5
75532	32	366	522	5
75534	34	385	660	5
75536	36	410	817	5
75541	41	460	1341	5
75546	46	500	1619	5
75550	50	540	2049	5



Llave combinada SAE

755		<i>l</i>	⚖	📦
Ref.	Medida	mm	g	ud/caja
7551.4	1/4"	106	17	10
7555.16	5/16"	126	26	10
7553.8	3/8"	146	42	10
7557.16	7/16"	156	49	10
7551.2	1/2"	176	72	10
7559.16	9/16"	186	84	10
7555.8	5/8"	206	113	10
75511.16	11/16"	216	124	10
7553.4	3/4"	236	167	5
75513.16	13/16"	256	229	5
7557.8	7/8"	266	220	5
75515.16	15/16"	286	279	5
7551.0	1"	306	335	5
7551.1.16	1-1/16"	316	375	5
7551.1.8	1-1/8"	346	530	5
7551.1.4	1-1/4"	366	527	5



Llave combinada corta con carraca

757S		<i>l</i>	⚖	📦
Ref.	Medida	mm	g	ud/caja
757S08	8	92	29	10
757S09	9	92	43	10
757S10	10	94	43	10
757S11	11	105	59	10
757S12	12	105	59	10
757S13	13	105	65	10
757S14	14	115	89	10
757S15	15	120	117	10
757S16	16	120	117	10
757S17	17	125	122	10
757S18	18	138	167	10
757S19	19	138	167	10



Llave combinada articulada con carraca

757..F		<i>l</i>	⚖	📦
Ref.	Medida	mm	g	ud/caja
75708F	8	130	50	10
75709F	9	155	73	10
75710F	10	155	73	10
75711F	11	173	99	10
75712F	12	173	99	10
75713F	13	185	116	10
75714F	14	191	133	10
75715F	15	215	198	10
75716F	16	215	198	10
75717F	17	230	223	10
75718F	18	248	276	10
75719F	19	248	276	10



Llave de media luna

761	●	<i>l</i>	⚖	📦
Ref.	Medida	mm	g	ud/caja
7610810	8x10	141	56	10
7611012	10x12	141	65	10
7611113	11x13	166	104	10
7611214	12x14	166	93	10
7611315	13x15	190	134	10
7611417	14x17	190	141	10
7611618	16x18	220	190	10
7611719	17x19	220	190	10
7611922	19x22	256	240	5



Llave combinada corta

755S		<i>l</i>	⚖	📦
Ref.	Medida	mm	g	ud/caja
755S08	8	91	25	10
755S09	9	97	32	10
755S10	10	97	32	10
755S11	11	100	45	10
755S12	12	105	47	10
755S13	13	108	55	10
755S14	14	115	67	10
755S15	15	118	76	10
755S16	16	122	88	10
755S17	17	130	108	10
755S18	18	133	115	10
755S19	19	138	134	10



Llave combinada con carraca

757		<i>l</i>	⚖	📦
Ref.	Medida	mm	g	ud/caja
75708	8	140	36	10
75709	9	150	46	10
75710	10	160	59	10
75711	11	165	69	10
75712	12	170	83	10
75713	13	180	99	10
75714	14	190	122	10
75715	15	200	132	10
75716	16	210	154	10
75717	17	223	181	10
75718	18	233	204	10
75719	19	244	241	10
75720	20	275	330	5
75721	21	275	330	5
75722	22	290	355	5
75723	23	290	355	5
75724	24	290	355	5



Llave de estrella acodada 75°

759	●	<i>l</i>	⚖	📦
Ref.	Medida	mm	g	ud/caja
7590607	6x7	168	53	10
7590809	8x9	183	64	10
7591011	10x11	198	100	10
7591213	12x13	217	132	10
7591415	14x15	239	161	10
7591617	16x17	260	206	10
7591719	17x19	292	257	5
7591819	18x19	292	258	5
7592022	20x22	318	319	5
7592123	21x23	327	388	5
7592426	24x26	329	492	5
7592427	24x27	329	496	5
7592528	25x28	347	536	5
7593032	30x32	362	664	5
7593436	34x36	415	908	5
7593641	36x41	450	1141	5



Llave de pipa abierta hexagonal

753	⬡	<i>l</i>	<i>l</i>	⚖	📦
Ref.	Medida	Corto	Largo	g	ud/caja
75306	6	26	102	40	10
75307	7	27	106	52	10
75308	8	28	114	66	10
75309	9	29	122	77	10
75310	10	33	129	96	10
75311	11	36	136	127	10
75312	12	40	144	163	10
75313	13	42	152	200	10
75314	14	45	160	217	10
75315	15	47	169	246	10
75316	16	51	178	315	5
75317	17	53	187	343	5
75318	18	54	195	368	5
75319	19	57	204	466	5
75320	20	59	212	466	5
75321	21	62	221	518	5
75322	22	66	230	574	5
75323	23	69	240	758	5
75324	24	72	250	854	5
75326	26	77	270	1049	5
75327	27	80	280	1170	5
75330	30	88	310	1552	5
75332	32	98	330	1718	5



Llave de tubo hexagonal de 2 bocas

762		<i>l</i>		
Ref.	Medida	mm	g	ud/caja
7620607	6x7	117	32	10
7620809	8x9	123	48	10
7621011	10x11	131	66	10
7621213	12x13	144	106	10
7621415	14x15	153	138	10
7621617	16x17	162	188	10
7621819	18x19	175	238	10
7622022	20x22	185	262	5
7622123	21x23	185	294	5
7622426	24x26	193	416	5
7622427 <small>NEW</small>	24x27	195	429	5
7622528	25x28	196	442	5
7622729	27x29	200	504	5
7623032	30x32	202	630	5



Llave allen de bola larga MM

765..L		<i>l</i>	<i>l</i>		
Ref.	Medida	Corto	Largo	g	ud/caja
7650127L	1.27	12	68	4	10
765015L	1.5	14	77	4	10
76502L	2	16	83	4	10
765025L	2.5	18	90	6	10
76503L	3	20	98	8	10
76504L	4	25	106	14	10
76505L	5	28	120	26	10
76506L	6	32	137	42	10
76507L	7	34	147	68	10
76508L	8	36	156	84	10
76510L	10	40	170	146	10
76512L	12	45	205	230	5
76514L	14	56	230	355	5



Llave allen

764		<i>l</i>	<i>l</i>		
Ref.	Medida	Corto	Largo	g	ud/caja
76409	9	38	105	90	10
76411	11	42	118	140	5
76417	17	63	160	527	5
76419	19	70	180	674	5
76422	22	80	200	991	5
76424	24	90	224	1344	5



Llave allen de bola larga SAE

765..L		<i>l</i>	<i>l</i>		
Ref.	Medida	Corto	Largo	g	ud/caja
7651.16L	1/16"	14	77	4	10
7655.64L	5/64"	16	83	4	10
7653.32L	3/32"	18	90	6	10
7651.8L	1/8"	20	98	8	10
7655.32L	5/32"	25	106	14	10
7653.16L	3/16"	28	118	26	10
7657.32L	7/32"	30	128	38	10
7651.4L	1/4"	32	137	42	10
7655.16L	5/16"	36	156	84	10
7653.8L	3/8"	40	170	142	10
7651.2L	1/2"	45	207	250	5



Llave Torx Inviolable larga

767..L		<i>l</i>	<i>l</i>		
Ref.	Medida	Corto	Largo	g	ud/caja
76706L	T-6H	18	68	5	10
76707L	T-7H	18	73	6	10
76708L	T-8H	18	77	6	10
76709L	T-9H	18	82	6	10
76710L	T-10H	19	86	6	10
76715L	T-15H	21	90	8	10
76720L	T-20H	23	95	11	10
76725L	T-25H	25	98	18	10
76727L	T-27H	26	105	19	10
76730L	T-30H	29	115	30	10
76740L	T-40H	33	122	45	10
76745L	T-45H	36	138	62	10
76750L	T-50H	40	155	90	10
76755L	T-55H	45	172	164	10
76760L	T-60H	52	200	267	5



Llave de estrella de golpe

793	<i>l</i>			
Ref.	Medida	mm	g	ud/caja
79327	27	180	340	10
79330	30	190	416	10
79332	32	190	416	10
79336	36	205	518	5
79338	38	205	518	5
79341	41	230	735	5
79346	46	240	930	5
79350	50	255	1162	5



Llave de carraca doble (para andamio)

8221922		<i>l</i>		
Ref.	Medidas	mm	g	ud/caja
8221922	19x22	315	450	2



Llave de gancho de uña

823	Medida		
Ref.	mm	Envase	Peso
823035	13-35	160/18.0/19.0/1.1'	110g
823050	35-50	80/17.0/18.0/1'	210g
823080	50-80	40/17.0/18.0/0.9'	425g
823120	80-120	24/18.0/19.0/1'	750g



Llave de gancho de pin

823A	Medida		
Ref.	mm	Envase	Peso
823A035	13-35	160/18.0/19.0/1.1'	110g
823A050	35-50	80/17.0/18.0/1'	210g
823A080	50-80	40/17.0/18.0/0.9'	425g
823A120	80-120	24/18.0/19.0/1'	750g



Juego de puntas de 1/4" de 8 pzs.

Ref.	100/14.0/15.0/1.5'	140g
2081C		
Contenido de 1/4":		
12130 1G...3G	3-Puntas Phillips PH.1; PH.2; PH.3 (30mm)	
12230 1G...3G	3-Puntas Pozidriv PZ.1; PZ.2; PZ.3 (30mm)	
1233007G	1-Punta plana de 7 mm (30mm)	
8152105	1-Adaptador angular de 1/4"	



Juego de puntas de 1/4" de 31 pzs.

Ref.	48/14.4/15.4/1.2'	300g
2313		
Contenido de 1/4":		
12125 0...3	6-Puntas Phillips de 25mm PH.0 x 1pz.; PH.1 x 2pzs. PH.2 x 2pzs.; PH.3 x 1pz.	
12225 1...3	5-Puntas Pozidriv de 25mm PZ.1 x 2pzs.; PZ.2 x 2pzs.; PZ.3 x 1pz.	
12325 055...065	3-Puntas planas 4; 5.5; 6.5 mm (25mm)	
12425 03...06	4- Puntas Allen 3; 4; 5; 6 mm (25mm)	
12625 05...40	12-Puntas Torx T5; T6; T7; T8; T9; T10; T15; T20; T25; T27; T30; T40 (25mm)	
81260Q	1-Prolongador magnético	



Juego de puntas de 1/4" de 31 pzs. especiales

Ref.	48/14.4/15.4/1.2'	300g
2315		
Contenido de 1/4":		
121S25 06...1.4	4-Puntas Torq de 25mm: 6; 8; 10; mm y 1/4"	
122S25 01...03	3-Puntas de 3 aletas de 25mm: PH.1; PH.2; PH.3	
123S25 04...10	4-Puntas abiertas de 25mm: 4; 6; 8; 10 mm	
124S25 02...06	6-Puntas allen inviolable de 25mm: 2; 2.5; 3; 4; 5; 6 mm	
12725 07...40	9-Puntas Torx inviolable de 25mm: T-7H; T-8H; T-10H; T-15H; T-20H; T-25H; T-27H; T-30H; T-40H	
124R25 0...3	4-Puntas cuadradas de 25mm: No.0; No.1; No.2; No.3	
81260Q	1-Prolongador magnético	



Destornillador de carraca con varillas de 26pzs.

Ref.	10/14.0/15.0/1'	1400g
2263		
Contenido de 1/4":		
121D 12...34	Phillips: PH1 x PH2; PH3 x PH4	
122D 12...34	Pozidriv: PZ1 x PZ2; PZ3 x PZ4	
123D 0304...05507	Planas: 3x4mm; 5.5x7mm	
124D 0304...0506	Allen: 3x4mm; 5x6mm	
126D 0810...3040	Torx: T8xT10; T15xT20; T25xT27 T30xT40	
525 04...12	11-Vasos hexagonales d 1/4": 4; 4.5; 5; 5.5; 6; 7; 8; 9; 10; 11; 12mm	
80922	1-Adaptador 1/4"H x 1/4"M	
8152R	1-Mango de destornillador de carraca	
88601	1-Imantador desimantador	



Varilla doble de destornillador de 1/4" Phillips

Ref.	Punta	mm	g	ud/caja
121D				
121D12	PH.1xPH.2	165	40	10
121D34	PH.3xPH.4	165	42	10



Varilla doble de destornillador de 1/4" Pozidriv

Ref.	Punta	mm	g	ud/caja
122D				
122D12	PZ.1xPZ.2	165	41	10
122D34	PZ.3xPZ.4	165	42	10



Varilla doble de destornillador de 1/4" Plana

Ref.	Punta	mm	g	ud/caja
123D				
123D0304	3mmx4mm	165	39	10
123D05507	5.5mmx7mm	165	41	10



Varilla doble de destornillador de 1/4" Allen

Ref.	Punta	mm	g	ud/caja
124D				
124D0304	3mmx4mm	165	40	10
124D0506	5mmx6mm	165	43	10



Varilla doble de destornillador de 1/4" Torx

Ref.	Punta	mm	g	ud/caja
126D				
126D0810	T8xT10	165	39	10
126D1520	T15xT20	165	40	10
126D2527	T25xT27	165	41	10
126D3040	T30xT40	165	42	10



Juego de puntas y vasos de 46 pzs.

Ref.	Vaso	24/17.8/18.8/1.5'	740g
K2463			
Contenido de 1/4"			
52Q 04...14	13-Vasos Spline 4; 4.5; 5; 5.5; 6; 7; 8; 9; 10; 11; 12; 13; 14 mm		
12125 0...3	31-Puntas de 1/4" de 25mm Phillips PH.0; PH.1; PH.2; PH.3		
12225 0...3	Pozidriv PZ.0; PZ.1; PZ.2; PZ.3		
12325 03...065	Planas 3; 4; 5; 5.5; 6.5 mm		
12425 03...08	Allen 3; 4; 5; 6; 7; 8 mm		
12725 10...40	Torx inviolable T-10H; T-15H; T-20H; T-25H; T-27H; T-30H; T-40H		
12825 04...10	Spline M4; M5; M6; M8; M10		
81022M	1-Portapuntas magnético 1/4"(H)x1/4(H)		
8149	1-Empuñadura de carraca		



Regleta de 6 vasos largos Torx hembra

Ref.	Torx H	60/10.2/11.2/1.5'	180g
2062			
Contenido de 1/4"			
52650 04...10	6- Vasos largos Torx Hembra E4; E5; E6; E7; E8; E10 (50mm)		



Regleta de 13 vasos poligonales de 1/4"

2133			
Ref.	Vaso	48/12.0/13.0/1.4'	270g

529 04...14
 Contenido de 1/4":
 13-Vasos poligonales cortos de 1/4":
 4; 4.5; 5; 5.5; 6; 7; 8; 9; 10; 11; 12;
 13; 14 mm



Juego de 14 vasos Spline cortos de 1/4"

2144Q			
Part no.	Vaso	48/11.0/12.0/1'	230g

52Q 032...14
 Contenido de 1/4":
 14- Vasos Spline cortos
 3.2; 4; 4.5; 5; 5.5; 6; 7; 8; 9; 10; 11;
 12; 13; 14 mm



Juego de 13 vasos Spline largos de 1/4"

2138Q			
Ref.	Vaso	48/21.0/22.0/1.2'	438g

52Q50 04...14
 Contenido de 1/4":
 13-Vasos Spline largos (50mm)
 4; 4.5; 5; 5.5; 6; 7; 8; 9; 10; 11; 12;
 13; 14 mm



Juego de vasos de 19 pzs. de 1/4" MM

2203-72-5			
Ref.	Vaso	15/14.0/15.0/1'	934g

525 04...14
 Contenido de 1/4":
 13-Vasos hexagonales cortos
 4; 4.5; 5; 5.5; 6; 7; 8; 9; 10; 11; 12;
 13; 14 mm
 80229 1-Carraca de 72 dientes
 8042 050...150 2-Extensiones de 50 y 150mm
 80521 1-Articulación universal
 8032115 1-Maneral corredizo
 8145 1-Destornillador portavasos



Juego de vasos de 19 pzs. de 1/4" MM

2203-72-9			
Ref.	Vaso	15/14.0/15.0/1'	934g

525 04...14
 Contenido de 1/4":
 13-Vasos poligonales cortos
 4; 4.5; 5; 5.5; 6; 7; 8; 9; 10; 11; 12;
 13; 14 mm
 80229 1-Carraca de 72 dientes
 8042 050...150 2-Extensiones de 50 y 150mm
 80521 1-Articulación universal
 8032115 1-Maneral corredizo
 8145 1-Destornillador portavasos



Juego de vasos de 19 pzs. de 1/4" SAE

2203S-72-9			
Ref.	Vaso	15/14.0/15.0/1'	934g

525 04...14
 Contenido de 1/4":
 13-Vasos poligonales cortos SAE
 5/32; 3/16; 7/32; 1/4; 9/32; 5/16;
 11/32; 3/8; 13/32; 7/16; 1/2; 9/16
 80229 1-Carraca de 72 dientes
 8042 050...150 2-Extensiones de 50 y 150mm
 80521 1-Articulación universal
 8032115 1-Maneral corredizo
 8145 1-Destornillador portavasos



Juego de vasos de 24 pzs. de 1/4" MM

2253-72			
Ref.	Vaso	15/15.5/16.5/1'	1033g

525 04...13
 Contenido de 1/4":
 11-Vasos hexagonales cortos
 4; 5; 5.5; 6; 7; 8; 9; 10; 11; 12;
 13 mm
 52550 05...13 9-Vasos hexagonales largos
 5; 6; 7; 8; 9; 10; 11; 12; 13 mm
 80229 1-Carraca de 72 dientes
 8042 050...150 2-Extensiones de 50 y 150mm
 8143 1-Destornillador portavasos



Juego de vasos de 24 pzs. de 1/4" MM

2253-72-9			
Ref.	Vaso	15/15.5/16.5/1'	1033g

525 04...13
 Contenido de 1/4":
 11-Vasos poligonales cortos
 4; 5; 5.5; 6; 7; 8; 9; 10; 11; 12;
 13 mm
 52550 05...13 9-Vasos poligonales largos
 5; 6; 7; 8; 9; 10; 11; 12; 13 mm
 80229 1-Carraca de 72 dientes
 8042 050...150 2-Extensiones de 50 y 150mm
 8143 1-Destornillador portavasos



Juego de vasos de 24 pzs. de 1/4" SAE

2253S-72-9			
Ref.	Vaso	15/15.5/16.5/1'	1033g

525 5.32...9.16
 Contenido de 1/4":
 11-Vasos poligonales cortos SAE
 5/32; 3/16; 7/32; 1/4; 9/32; 5/16;
 11/32; 3/8; 7/16; 1/2; 9/16
 52550 3.16...9.16 9-Vasos poligonales largos SAE
 3/16; 1/4; 9/32; 5/16; 11/32; 3/8;
 7/16; 1/2; 9/16
 80229 1-Carraca de 72 dientes
 8042 050...150 2-Extensiones de 50 y 150mm
 8143 1-Destornillador portavasos



Juego de vasos de 28 pzs. de 1/4" MM

Ref.	Vaso	15/14.8/15.8/1'	986g
2281-72-5			
525 04...14	Contenido de 1/4": 11-Vasos hexagonales cortos 4; 5; 6; 7; 8; 9; 10; 11; 12; 13; 14 mm		
32432 03...06	10-Vasos con punta (32mm) Allen 3; 4; 5; 6 mm		
32332 04...07	Plana 4; 5.5; 7 mm		
32132 1...3	Phillips PH.1; PH.2; PH.3		
80229	1-Carraca de 72 dientes		
8042 050...150	2-Extensiones de 50 y 150mm		
8032115	1-Maneral corredizo		
80521	1-Articulación universal		
8143	1-Destornillador portavasos		



Juego de vasos de 28 pzs. de 1/4" SAE

Ref.	Vaso	15/14.8/15.8/1'	986g
2281S-72			
529 04...14	Contenido de 1/4": 11-Vasos poligonales cortos 5/32; 3/16; 7/32; 1/4; 9/32; 5/16; 11/32; 3/8; 7/16; 1/2; 9/16		
32432 03...06	10-Vasos con punta (32mm) Allen 1/8; 5/32; 3/16; 1/4		
32332 04...07	Plana 4; 5.5; 7 mm		
32132 1...3	Phillips PH.1; PH.2; PH.3		
80229	1-Carraca de 72 dientes		
8042 050...150	2-Extensiones de 50 y 150mm		
8032115	1-Maneral corredizo		
80521	1-Articulación universal		
8143	1-Destornillador portavasos		



Juego de vasos de 28 pzs. de 1/4" MM

Ref.	Vaso	15/14.8/15.8/1'	986g
2281-72			
529 04...14	Contenido de 1/4": 11-Vasos poligonales cortos 4; 5; 6; 7; 8; 9; 10; 11; 12; 13; 14 mm		
32432 03...06	10-Vasos con punta (32mm) Allen 3; 4; 5; 6 mm		
32332 04...07	Plana 4; 5.5; 7 mm		
32132 1...3	Phillips PH.1; PH.2; PH.3		
80229	1-Carraca de 72 dientes		
8042 050...150	2-Extensiones de 50 y 150mm		
8032115	1-Maneral corredizo		
80521	1-Articulación universal		
8143	1-Destornillador portavasos		



Juego de vasos de 29 pzs. de 1/4" MM

Ref.	Vaso	20/14.8/15.8/1'	740g
2292-9			
529 04...13	Contenido de 1/4": 12-Vasos poligonales cortos 4; 4.5; 5; 5.5; 6; 7; 8; 9; 10; 11; 12; 13 mm		
32432 03...08	Allen 3; 4; 5; 6; 8 mm		
32332 04...07	Plana 4; 5.5; 7 mm		
32132 01...02	Phillips PH.1; PH.2		
32232 01...02	Pozidriv PZ.1; PZ.2		
80222	1-Carraca de 24 dientes		
8032115	1-Maneral corredizo		
8042050	1-Extensión de 50		
80521	1-Articulación universal		
8143	1-Destornillador portavasos		



Juego de vasos de 31 pzs. de 1/4" MM y SAE

Ref.	Vaso	15/16/17/1'	1066g
2312-72			
529 04...14	Contenido de 1/4": 13-Vasos poligonales cortos MM 4; 4.5; 5; 5.5; 6; 7; 8; 9; 10; 11; 12; 13; 14 mm		
529 3.16...9.16	10-Vasos poligonales cortos SAE 3/16"; 7/32"; 1/4"; 9/32"; 5/16"; 11/32"; 3/8"; 7/16"; 1/2"; 9/16"		
80229	1-Carraca de 72 dientes		
8042 050...150	2-Extensiones de 50 y 150mm		
80622	1-Adaptador para extensión 1/4"(H)x1/4"(M)		
80521	1-Articulación universal		
8145	1-Destornillador portavasos		
81022	1-Vaso portapuntas 1/4".x1/4" H		
8111	1-Extensión flexible		



Juego de vasos de 31 pzs. de 1/4" MM y SAE

Ref.	Vaso	15/16/17/1'	1066g
2312-72-5			
529 04...14	Contenido de 1/4": 13-Vasos hexagonales cortos MM 4; 4.5; 5; 5.5; 6; 7; 8; 9; 10; 11; 12; 13; 14 mm		
529 3.16...9.16	10-Vasos hexagonales cortos SAE 3/16"; 7/32"; 1/4"; 9/32"; 5/16"; 11/32"; 3/8"; 7/16"; 1/2"; 9/16"		
80229	1-Carraca de 72 dientes		
8042 050...150	2-Extensiones de 50 y 150mm		
80622	1-Adaptador para extensión 1/4"(H)x1/4"(M)		
80521	1-Articulación universal		
8145	1-Destornillador portavasos		
81022	1-Vaso portapuntas 1/4".x1/4" H		
8111	1-Extensión flexible		



Juego de vasos de 42 pzs. de 1/4" MM

2421			
Ref.	Vaso	20/18.0/19.0/0.82	900g
525 032...14	Contenido de 1/4": 14-Vasos hexagonales cortos 3.2; 4; 4.5; 5; 5.5; 6; 7; 8; 9; 10; 11; 12; 13; 14 mm		
12425 03...08	20-Puntas de 1/4" (25mm) Allen 3, 4, 5, 6, 8 mm		
12625 10...40	Torx T10, T15, T20, T25, T30, T40		
12325 04...065	Plana 4, 5.5, 6.5 mm		
12125 1...3	Phillips PH.1, PH.2, PH.3		
12225 1...3	Pozidriv PZ.1, PZ.2, PZ.3		
80229	1-Carraca de 72 dientes		
8042 050...150	2-Extensiones de 50 y 150mm		
80521	1-Articulación universal		
81022	1-Portapuntas 1/4"(H)x1/4"(H)		
8143	1-Destornillador portavasos		
80632	1-Adaptador para extensión 3/8"(H)x1/4"(M)		
81225	1-Vaso magnético		

Juego de vasos de 42 pzs. de 1/4" MM

2421-9			
Ref.	Vaso	20/18.0/19.0/0.82	900g
525 032...14	Contenido de 1/4": 14-Vasos poligonales cortos 3.2; 4; 4.5; 5; 5.5; 6; 7; 8; 9; 10; 11; 12; 13; 14 mm		
12425 03...08	20-Puntas de 1/4" (25mm) Allen 3, 4, 5, 6, 8 mm		
12625 10...40	Torx T10, T15, T20, T25, T30, T40		
12325 04...065	Plana 4, 5.5, 6.5 mm		
12125 1...3	Phillips PH.1, PH.2, PH.3		
12225 1...3	Pozidriv PZ.1, PZ.2, PZ.3		
80229	1-Carraca de 72 dientes		
8042 050...150	2-Extensiones de 50 y 150mm		
80521	1-Articulación universal		
81022	1-Portapuntas 1/4"(H)x1/4"(H)		
8143	1-Destornillador portavasos		
80632	1-Adaptador para extensión 3/8"(H)x1/4"(M)		
81225	1-Vaso magnético		

Juego de vasos de 42 pzs. de 1/4" SAE

2421S-9			
Ref.	Vaso	20/18.0/19.0/0.82	900g
525 032...14	Contenido de 1/4": 14-Vasos poligonales cortos SAE 5/32; 3/16; 7/32; 1/4; 9/32; 5/16; 11/32; 3/8; 7/16; 15/32; 1/2; 9/16		
12425 03...08	20-Puntas de 1/4" (25mm) Allen 1/8; 5/32; 3/16; 1/4; 5/16		
12625 10...40	Torx T10, T15, T20, T25, T30, T40		
12325 04...065	Plana 4, 5.5, 6.5 mm		
12125 1...3	Phillips PH.1, PH.2, PH.3		
12225 1...3	Pozidriv PZ.1, PZ.2, PZ.3		
80229	1-Carraca de 72 dientes		
8042 050...150	2-Extensiones de 50 y 150mm		
80521	1-Articulación universal		
81022	1-Portapuntas 1/4"(H)x1/4"(H)		
8143	1-Destornillador portavasos		
80632	1-Adaptador para extensión 3/8"(H)x1/4"(M)		
81225	1-Vaso magnético		

Juego de vasos de 42 pzs. de 1/4" MM

2421F			
Ref.	Vaso	20/18.0/19.0/0.82	900g
525 032...14	Contenido de 1/4": 14-Vasos hexagonales cortos 3.2; 4; 4.5; 5; 5.5; 6; 7; 8; 9; 10; 11; 12; 13; 14 mm		
12425 03...08	20-Puntas de 1/4" (25mm) Allen 1/8; 5/32; 3/16; 1/4; 5/16		
12625 10...40	Torx T10, T15, T20, T25, T30, T40		
12325 04...065	Plana 4, 5.5, 6.5 mm		
12125 1...3	Phillips PH.1, PH.2, PH.3		
12225 1...3	Pozidriv PZ.1, PZ.2, PZ.3		
802218	1-Carraca articulada de 24 dientes		
8042 050...150	2-Extensiones de 50 y 150mm		
80521	1-Articulación universal		
81022	1-Portapuntas 1/4"(H)x1/4"(H)		
8143	1-Destornillador portavasos		
80632	1-Adaptador para extensión 3/8"(H)x1/4"(M)		
81225	1-Vaso magnético		



Juego de vasos de 46 pzs de 1/4" MM

Ref.	Vaso	10/13/14/1.3'	1300g
2461-5	Contenido de 1/4"		
527 04...14	13-Vasos hexagonales cortos 4; 4.5; 5; 5.5; 6; 7; 8; 9; 10; 11; 12; 13; 14 mm		
52750 08...13	4-Vasos hexagonales largos 8; 10; 12; 13 (50mm) 20-		
32432 03...08	Vasos con punta (32mm) Allen 3; 4; 5; 6; 8 mm		
32632 10...40	Torx T10; T15; T20; T25; T30; T40		
32332 04...065	Planas 4; 5.5; 6.5 mm		
32132 1...3	Phillips PH.1; PH.2; PH.3		
32232 1...3	Pozidriv PZ.1; PZ.2; PZ.3		
80222	1-Carraca de 24 dientes		
8042 050...100	2-Extensiones de 50 y 150mm		
8032115	1-Maneral corredizo		
80521	1-Articulacion universal		
8143	1-Destornillador portavasos		
764-3	3-Llaves allen 1.5; 2; 2.5 mm		



Vaso con punta de 1/4" Phillips

321	+	l	g	ud/caja
Ref.	Medida	mm	g	ud/caja
321321	PH.1	32	12	50
321322	PH.2	32	12	50
321323	PH.3	32	14	50



Vaso con punta de 1/4" Pozidriv

322	+	l	g	ud/caja
Ref.	Medida	mm	g	ud/caja
322321	PZ.1	32	12	50
322322	PZ.2	32	12	50
322323	PZ.3	32	14	50



Vaso con punta de 1/4" Allen

324	○	l	g	ud/caja
Ref.	Medida	mm	g	ud/caja
3243203	3	32	13	50
3243204	4	32	14	50
3243205	5	32	14	50
3243206	6	32	14	50
3243207	7	32	16	50
3243208	8	32	17	50
3243210	10	32	21	50



Vaso con punta de 1/4" Torx

326	✦	l	g	ud/caja
Ref.	Medida	mm	g	ud/caja
3263208	T8	32	13	50
3263209	T9	32	13	50
3263210	T10	32	13	50
3263215	T15	32	13	50
3263220	T20	32	14	50
3263225	T25	32	14	50
3263227	T27	32	14	50
3263230	T30	32	14	50
3263240	T40	32	15	50



Vaso corto hexagonal de 1/4"

527	⬢	l	g	ud/caja
Ref.	Medida	mm	g	ud/caja
52704	4	25	10	50
52705	5	25	10	50
52706	6	25	11	50
52707	7	25	12	50
52708	8	25	12	50
52709	9	25	13	50
52710	10	25	15	50
52711	11	25	24	50
52712	12	25	28	50
52713	13	25	32	50
52714	14	25	36	50



Vaso largo poligonal de 1/4"

52950	⬢	l	g	ud/caja
Ref.	Medida	mm	g	ud/caja
5295005	5	50	18	50
52950055	5.5	50	18	50
5295006	6	50	21	50
5295007	7	50	22	50
5295008	8	50	22	50
5295009	9	50	28	40
5295010	10	50	33	30
5295011	11	50	44	30
5295012	12	50	44	20
5295013	13	50	45	20



Carraca de 1/4" de 24 dientes

80222	l	g	ud/caja
Ref.	mm	g	ud/caja
80222	155	150	1



Carraca de 1/4" de 24 dientes

802211	l	g	ud/caja
Ref.	mm	g	ud/caja
802211	140	168	1



Carraca de 1/4" de 72 dientes

80229	l		
Ref.	mm	g	ud/caja
80229	115	132	1



Carraca de 1/4" de 20 dientes articulada

802218	l		
Ref.	mm	g	ud/caja
802218	125	146	1



Carraca de 1/4" de 72 dientes articulada

802223	l		
Ref.	mm	g	ud/caja
802223	150	126	1



Portapuntas de cambio rápido de 1/4"

81260Q	l			
Ref.	mm	g	ud/caja	
81260Q	1/4"Hex-1/4"Hex	60	32	10



Amplificador de 1/4" a 3/8"

80923	l			
Ref.	mm	g	ud/caja	
80923	1/4"(F) x3/8"(M)	26	18	25



Articulación universal de 1/4"

80521	l		
Ref.	mm	g	ud/caja
80521	37	23	20



Vaso portapuntas de 1/4"

81022	l			
Ref.	mm	g	ud/caja	
81022	1/4"(F) x1/4"(F)	25	14	50



Extensión de 1/4"

8042	l		
Ref.	mm	g	ud/caja
8042050	50-2"	23	20
8042075 NEW	75-3"	34	10
8042100	100-4"	46	10
8042125 NEW	125-5"	54	10
8042150	150-6"	66	10
8042250	250-10"	110	10



Juego de 4 extensiones de 1/4" en estuche

K2047

Contenido de 1/4"
4-Extensiones de:
050W...150W 50; 75; 100; 150mm

24/9.6/10.6/1.5' 402g



Extensión flexible de 1/4"

8111	l			
Ref.	mm	g	ud/caja	
8111	1/4"DR.	145	61	10



Destornillador portavasos flexible de 1/4"

8113	l			
Ref.	mm	g	ud/caja	
8113	1/4"DR.	275-11"	151	10



Destornillador portavasos de 1/4"

8143	l			
Ref.	mm	g	ud/caja	
8143	1/4"DR.	150-6"	104	10



Maneral corredizo de 1/4"

8032115	l		
Ref.	mm	g	ud/caja
8032115	115	42	10



Adaptador acodado para máquina de 1/4"

827B03

- Máximo 57Nm
- Empuñadura ajustable a cualquier ángulo

48/18.6/19.3/1.2' 388g



Regleta de 7 vasos Ribe largos de 3/8" y 1/2"

3078			
Ref.	Ribe	20/20.0/21.0/1.2'	1000g
339090 06...10	Contenido de 3/8" y 1/2" 4-Vasos punta Ribe de 3/8" (90mm) M6; M7; M8; M10		
349100 12...14	3-Vasos punta Ribe de 1/2" (100mm) M12; M13; M14		



Juego de vasos de 21 pzs de 3/8" SAE

3212			
Ref.	Vaso	6/12.2/13.2/0.9'	2030g
535 1.4...7.8	Contenido de 3/8" 13-Vasos hexagonales cortos 1/4"; 5/16"; 3/8"; 7/16"; 1/2"; 9/16"; 19/32"; 5/8"; 11/16"; 3/4"; 25/32"; 13/16"; 7/8"		
80232	1-Carraca de 24 dientes		
8033165	1-Maneral corredizo		
8043 075...250	3-Extensiones de 75, 150 y 250mm		
80531	1-Articulación universal		
8073 16...20.6	2-Vasos para bujías de 16; 20.6 mm		



Juego de vasos de 23 pzs de 3/8"

3232			
Ref.	Vaso	10/19.0/20.0/1'	1900g
535 06...22	Contenido de 3/8" 17-Vasos hexagonales cortos 6; 7; 8; 9; 10; 11; 12; 13; 14; 15; 16; 17; 18; 19; 20; 21; 22 mm		
80239	1-Carraca de 72 dientes		
8043 075...225	3-Extensiones de 75, 150 y 225mm		
80531	1-Articulación universal		
80643	1-Adaptador para extensión 1/2"(H)x3/8"(M)		



Juego de vasos de 24 pzs de 3/8"

3251			
Ref.	Vaso	6/13.9/14.9/0.9'	2320g
537 06...22	Contenido de 3/8" 17-Vasos hexagonales 6; 7; 8; 9; 10; 11; 12; 13; 14; 15; 16; 17; 18; 19; 20; 21; 22 mm		
80232	1-Carraca de 24 dientes		
8043 075...150	2-Extensiones de 75 y 150mm		
80531	1-Articulación universal		
8033165	1-Maneral corredizo		
8073 16...20.6	2-Vasos para bujías de 16; 20.6 mm		



Regleta de 9 vasos Torx inviolable de 5 puntas de 1/4" y 3/8"

3095			
Ref.	Punta	30/7.0/8.0/0.9'	233g
32F32 10...40	Contenido de 1/4" y 3/8". 7-Puntas Torx inviolable de 5 puntas de 1/4" TS10; TS15; TS20; TS25; TS27; TS30; TS40		
33F50 45...50	2-Puntas Torx inviolable de 5 puntas de 3/8" TS45; TS50		



Juego de vasos de 21 pzs de 3/8" SAE

3212-9			
Ref.	Vaso	6/12.2/13.2/0.9'	2030g
535 1.4...7.8	Contenido de 3/8" 13-Vasos poligonales cortos 1/4"; 5/16"; 3/8"; 7/16"; 1/2"; 9/16"; 19/32"; 5/8"; 11/16"; 3/4"; 25/32"; 13/16"; 7/8"		
80232	1-Carraca de 24 dientes		
8033165	1-Maneral corredizo		
8043 075...250	3-Extensiones de 75, 150 y 250mm		
80531	1-Articulación universal		
8073 16...20.6	2-Vasos para bujías de 16; 20.6 mm		



Juego de vasos de 23 pzs de 3/8"

3232-9			
Ref.	Vaso	10/19.0/20.0/1'	1900g
535 06...22	Contenido de 3/8" 17-Vasos poligonales cortos 6; 7; 8; 9; 10; 11; 12; 13; 14; 15; 16; 17; 18; 19; 20; 21; 22 mm		
80239	1-Carraca de 72 dientes		
8043 075...225	3-Extensiones de 75, 150 y 225mm		
80531	1-Articulación universal		
80643	1-Adaptador para extensión 1/2"(H)x3/8"(M)		



Juego de vasos de 24 pzs de 3/8"

3251-72			
Ref.	Vaso	6/13.9/14.9/0.9'	2320g
537 06...22	Contenido de 3/8" 17-Vasos hexagonales 6; 7; 8; 9; 10; 11; 12; 13; 14; 15; 16; 17; 18; 19; 20; 21; 22 mm		
80232	1-Carraca de 72 dientes		
8043 075...150	2-Extensiones de 75 y 150mm		
80531	1-Articulación universal		
8033165	1-Maneral corredizo		
8073 16...20.6	2-Vasos para bujías de 16; 20.6 mm		



Juego de vasos de 24 pzs de 3/8"

Ref.	Vaso	6/13.9/14.9/0.9"	2320g
537 06...22	Contenido de 3/8" 17-Vasos poligonales 6; 7; 8; 9; 10; 11; 12; 13; 14; 15; 16; 17; 18; 19; 20; 21; 22 mm		
80232	1-Carraca de 72 dientes		
8043 075...150	2-Extensiones de 75 y 150mm		
80531	1-Articulación universal		
8033165	1-Maneral corredizo		
8073 16...20.6	2-Vasos para bujías de 16; 20.6 mm		



Juego de vasos de 32 pzs de 3/8" (MM & SAE)

Ref.	Vaso	6/15.0/16.0/0.9"	2500g
535 06...22	Contenido de 3/8" 15-Vasos hexagonales cortos MM 6; 7; 8; 9; 10; 11; 12; 13; 14; 15; 16; 17; 18; 19; 20; 21; 22 mm		
535 1.4...13.16	11-Vasos hexagonales cortos SAE 1/4"; 3/8"; 1/2"; 9/16"; 5/8"; 11/16"; 13/16"		
8043 075...225	3-Extensiones de 75, 150 y 225mm		
80643	1-Adaptador para extensión 1/2"(H)x3/8"(M)		
80531	1-Articulación universal		
802322	1-Carraca de 72 dientes		
8073 16...20.6	2-Vasos para bujías de 16; 20.6 mm		

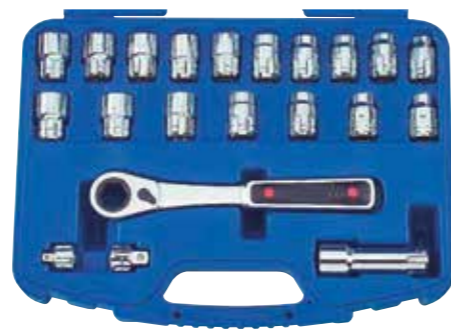

Juego de vasoss pasantes de 21 pzs. (SAE & MM)

Ref.	Vaso	1710g
3213	Contenido de 3/8" 17- Vasos pasantes 3/8"; 7/16"; 1/2"; 9/16"; 5/8"; 11/16"; 3/4" 10; 11; 12; 13; 14; 15; 16; 17; 18; 19 mm 2- Adaptadores de cuadradillo 3/8"; 1/4" 1- Extensión de 75mm 1- Caraca hueca de 72 dientes	



Punta de 5/16" Phillips

Ref.	Medida	mm	g	ud/caja
151302	PH.2	30	10	10
151303	PH.3	30	10	10
151304	PH.4	30	11	10



Punta de 5/16" Pozidriv

Ref.	Medida	mm	g	ud/caja
152302	PZ.2	30	10	10
152303	PZ.3	30	10	10
152304	PZ.4	30	10	10



Punta plana de 5/16"

Ref.	Medida	mm	g	ud/caja
1533007	1.2x7	30	10	10
1533008	1.2x8	30	12	10
1533010	1.6x10	30	14	10
1533012	2.0x12	30	14	10



Punta de 5/16" Allen

Ref.	Medida	mm	g	ud/caja
1543004	4	30	9	10
1543005	5	30	10	10
1543006	6	30	11	10
1543007	7	30	12	10
1543008	8	30	12	10
1543010	10	30	16	10
1543012	12	30	21	10
1543014	14	30	25	10



Punta de 5/16" Torx

Ref.	Medida	mm	g	ud/caja
1563025	T25	30	9	10
1563030	T30	30	10	10
1563040	T40	30	10	10
1563045	T45	30	11	10
1563050	T50	30	12	10



Vaso con punta Torx inviolable de 5 puntas de 3/8"

Ref.	Medida	mm	g	ud/caja
33F5045	TS45	50	52	20
33F5050	TS50	50	52	20



Vaso hexagonal de 3/8"

Ref.	Medida	mm	g	ud/caja
53706	6	28	22	20
53707	7	28	23	20
53708	8	28	24	20
53709	9	28	24	20
53710	10	28	24	20
53711	11	28	25	20
53712	12	28	25	20
53713	13	28	28	20
53714	14	30	36	20
53715	15	30	44	20
53716	16	30	44	20
53717	17	30	47	20
53718	18	30	47	20
53719	19	30	55	20
53720	20	30	66	20
53721	21	30	66	20
53722	22	32	74	20



Vaso poligonal largo de 3/8"

Ref.	Medida	l mm	g	ud/caja
53963				
5396306	6	63	50	20
5396307	7	63	50	20
5396308	8	63	54	20
5396309	9	63	54	20
5396310	10	63	66	20
5396311	11	63	66	20
5396312	12	63	66	20
5396313	13	63	82	20
5396314	14	63	82	20
5396315	15	63	88	20
5396316	16	63	102	20
5396317	17	63	120	10
5396318	18	63	130	10
5396319	19	63	138	10
5396320	20	63	176	10
5396321	21	63	194	10
5396322	22	63	220	10



Vaso Torx hembra corto de 3/8"

Ref	Medida	l mm	g	ud/caja
536				
53604	E4	28	22	20
53605	E5	28	23	20
53606	E6	28	23	20
53607	E7	28	23	20
53608	E8	28	23	20
53610	E10	28	24	20
53611	E11	28	25	20
53612	E12	28	26	20
53614	E14	28	27	20
53616	E16	28	30	20
53618	E18	28	36	20
53620	E20	28	46	20



Carraca de 24 dientes de 3/8"

Ref.	l mm	g	ud/caja
802311			
802311	195	374	1



Carraca de 24 dientes de 3/8"

Ref.	l mm	g	ud/caja
802315			
802315	175	324	1



Carraca de 72 dientes de 3/8"

Ref.	l mm	g	ud/caja
80239			
80239	195	248	1

* 80239-P Repuesto



Carraca de 72 dientes de 3/8" articulada

Ref.	l mm	g	ud/caja
802323			
802323	225	404	1



Adaptador de 3/8"

Ref.	Medida	l mm	g	ud/caja
8093				
80932	3/8(H) x 1/4"(M)	35	31	10
80934	3/8(H) x 1/2"(M)	46	47	10



Extensión de 3/8"

Ref.	l mm	g	ud/caja
8043			
8043075	75-3"	78	10
8043150	150-6"	148	10
8043225	225-9"	220	10

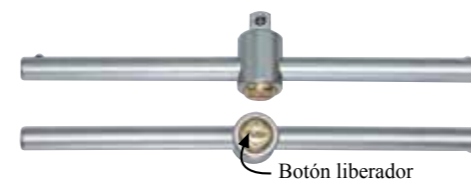

Botón liberador

Maneral corredizo de 3/8" con botón

Ref.	l mm	g	ud/caja
8033200L			
8033200L	200-8"	184	10



Articulación universal de 3/8"

Ref.	l mm	g	ud/caja
80531			
80531	46	61	10



Juego de puntas XZN de 7 pzs. de 1/2"

4072			
Ref.	XZN	60/16.5/17.5/1.3'	275g
Contenido de 1/2":			
6-Puntas XZN de 10mm			
M6; M8; M10 (30mm)			
M8; M10; M12 (75mm)			
1-Vaso portapuntas 1/2"H.x10mm			
17830 06...10			
17875 08...12			
81047			



Juego de puntas Torx de 8 pzs. de 1/2"

4081			
Ref.	Torx	100/19.0/20.0/1.6'	190g
Contenido de 1/2":			
7-Puntas Torx de 10mm (30mm)			
T20; T25; T30; T40; T45; T50; T55			
1-Vaso portapuntas 1/2"H.x10mm			
17630 20...55			
81047			



Juego de 8 vasos hexagonales largos de 1/2"

4082			
Ref.	Vaso	12/17.3/18.3/1'	1440g
Contenido de 1/2":			
8-Vasos hexagonales largos			
13; 14; 15; 17; 19; 21; 22; 24 mm			
54577 13...24			



Juego de 8 vasos Torx Hembra largos de 1/2"

4083			
Ref.	Vaso	12/13.5/14.5/1'	1125g
Contenido de 1/2":			
8-Vasos Torx hembra largos			
E10; E11; E12; E14; E16; E18;			
E20; E24			
54677 10...24			



Juego de 8 adaptadores de cuadrado

K4087			
Ref.	Adaptador	24/26.5/27.5/1.5'	1750g
Contenido de 1/2":			
8-Adaptadores			
1/4"(H)x3/8"(M); 3/8"(H)x1/4"(M);			
3/8"(H)x1/2"(M); 1/2"(H)x3/8"(M);			
1/2"(H)x3/4"(M); 3/4"(H)x1/2"(M);			
3/4"(H)x1"(M); 1"(H)x3/4"(M)			
809 23...86			



Juego de 9 vaos Torx hembra de 1/2"

4093			
Ref.	Vaso	20/24.0/25.0/1.1'	1200g
Contenido de 1/2":			
9-Vasos Torx hembra			
E10; E11; E12; E14; E16; E18;			
E20; E22; E24			
546 10...24			



Juego de 9 vasos con punta Torx de 1/2"

4102			
Ref.	Vaso	20/22.0/23.0/0.82'	1100g
Contenido de 1/2":			
9-Vasos con punta Torx			
T20; T25; T27; T30; T40; T45;			
T50; T55; T60 (55mm)			
346055 20...60			



Regleta de 10 vasos hexagonales de 1/2" MM

4106			
Ref.	Vaso	20/16.0/17.0/1.3'	800g
Contenido de 1/2":			
10-Vasos hexagonales			
11; 12; 13; 14; 15; 17; 19; 21; 22;			
24 mm			
545 11...24			



Juego de 10 vasos largos Spline de 1/2"

41014Q			
Ref.	Vaso	24/36.0/37.0/1.4'	1500g
Contenido de 1/2":			
10-Vasos largos Spline			
10; 11; 12; 13; 14; 15; 17; 19; 22;			
24 mm			
54Q77 10...24			



Juego de 10 vasos con punta allen MM

4111			
Ref.	Vaso	15/23.4/24.4/1'	1560g
Contenido de 1/2":			
10-Vasos con pnta allen			
4; 5; 6; 7; 8; 10; 12 mm (55mm)			
14 mm (65mm)			
17; 19 mm (70mm)			
344055 04...12			
34406514			
344070 17...19			



Juego de 10 vasos con punta allen SAE

4111S			
Ref.	Vaso	15/23.4/24.4/1'	1560g
Contenido de 1/2":			
10-Vasos con pnta allen			
5/32"; 3/16"; 7/32"; 1/4"; 5/16";			
3/8"; 1/2" (55mm)			
9/16"; 5/8" (65mm)			
3/4" (70mm)			
344055 5.32...1.2			
344065 9.16...5.8			
3440703.4			



Juego de 11 vasos Torx hembra de 1/4", 3/8" y 1/2"

4113			
Ref.	Torx H	36/16.5/17.5/1.6'	458g
Contenido de 1/4", 3/8" y 1/2":			
11-Vasos Torx hembra			
526 05...08	1/4"DR.: E5; E6; E7; E8		
536 10...14	3/8"DR.: E10; E11; E12; E14		
546 16...20	1/2"DR.: E16; E18; E20		



Juego de 16 vasos Torx Macho y Hembra

4171			
Ref..	Torx	10/20.0/21.0/0.7'	2000g
Contenido de 1/2":			
9-Vasos Torx hembra			
E10; E11; E12; E14; E16; E18;			
E20; E22; E24			
7-Vasos con punta Torx (55mm)			
T30; T40; T45; T50; T55; T60; T70			



Juego de 12 vasos Spline hembra de 1/2"

4124Q			
Ref..	Spline	36/29.0/30.0/1.6'	806g
Contenido de 1/2":			
12-Vasos spline			
10; 11; 12; 13; 14; 15; 16; 17; 19;			
21; 22; 24 mm			



Juego de puntas allen de 10mm de 15 pzs.

4155			
Ref.	Allen	20/16.0/17.0/0.82'	800g
Contenido:			
14-Puntas allen de 10mm			
4; 5; 6; 7; 8; 10; 12 mm de 30mm			
4; 5; 6; 7; 8; 10; 12 mm de 75mm			
1-Portapuntas de 1/2" x 10mm			



Juego de 18 vasos Torx Macho y Hembra de 3/8 y 1/2"

4192			
Ref..	Torx	10/16.5/17.5/0.7'	1650g
Contenido de 3/8" y 1/2":			
6-Vasos Torx hembra 3/8"			
E10; E11; E12; E14; E16; E18			
3-Vasos Torx hembra 1/2"			
E20; E22; E24			
5- Vasos con punta Torx 3/8"			
T20; T25; T27; T30; T40 (50mmL)			
4-Vasos con punta Torx 1/2"			
T45; T50; T55; T60 (55mmL)			



Juego de puntas Ribe de 22 pzs.

4225			
Ref.	Ribe	15/18.2/19.2/1'	1230g
Contenido:			
20 Puntas Ribe de 10mm largas y cortas:			
M4; M5; M6; M7; M8; M9; M10;			
M12; M13; M14 de 30mm			
M4; M5; M6; M7; M8; M9; M10;			
M12; M13; M14 de 75mm			
2-Portapuntas:			
3/8" x 10mm; 1/2" x 10mm			



Juego de 26 vasos de punta Torx

4263			
Ref.	Torx	4/14.9/15.9/1.3'	3725g
Contenido:			
12-Vasos con punta Torx cortos (55mm)			
T20; T25; T27; T30; T35; T40;			
T45; T47; T50; T55; T60; T70.			
13-Vasos con punta Torx largos (100mm)			
T20; T25; T27; T30; T40; T45; T50;			
T55; T60; T70; T80; T90; T100. 1-			
Vaso con punta Torx (140mmL) T60.			



Juego de 26 vasos de punta Ribe

4265			
Ref.	Ribe	4/15.7/16.7/1.3'	3925g
Contenido:			
10-Vasos con punta Ribe largos (100mm)			
M5; M6; M7; M8; M9; M10; M12;			
M13; M14; M16.			
5-Vasos con punta Ribe largos (140mm)			
M8; M9; M10; M12; M14			
1-Vaso con punta Ribe largos (140mm)			
M10V			
9-Vasos con punta Ribe inviolable			
largos (63mm)			
M5; M6; M7; M8; M9; M10; M12;			
M14; M16.			
1-Vaso con punta Ribe corto (55mm)			
M6.			



Juego de 26 vasos de punta Especial

4266	4/18.8/19.8/1.3' 4700g
Ref.	
344100 11...13	Contenido 2-Vasos punta allen largos (100mm) 11; 13.
34414010	1-Vaso punta allen largo (140mm) 10mm.
346100 60...70	2-Vasos punta Torx largos (100mm) T60; T70.
34614060	1-Vaso punta Torx largo (140mmL) T60.
34710055	1-Vaso punta Torx inviolable largo (100mm) T-55H.
34710570	1-Vaso punta Torx inviolable largo (105mm) T-70H.
34713030	1-Vaso punta Torx inviolable largo (130mm) T-30H.
34714080	1-Vaso punta Torx inviolable largo (140mm) T-80H.
34810014	1-Vaso punta XZN largo (100mm) M14.
34812009	1-Vaso punta XZN largo (120mm) M9.
348140 08...12	4-Vasos punta XZN largos (140mm) M8; M9; M10; M12.
34805516T	1-Vaso punta XZN inviolable corto (55mm) M16.
34810016T	1-Vaso punta XZN inviolable largo (100mm) M16.
34910013	1-Vaso punta Ribe largo (100mm) M13.
34912012	1-Vaso punta Ribe largo (120mm) M12.
34914009	1-Vaso punta Ribe largo (140mm) M9.
34914010V	1-Vaso punta Ribe largo (140mm) M10V.
674	2-Vasos para alternadores M10 1-Vaso con punta XZN M10x110mm para alternador
678	1-Vaso con punta Torx T50x110mm para alternador



Juego de 28 vasos de punta XZN

4285	4/17.6/18.6/1.3' 4400g
Ref.	
348055 05...16	Contenido 8-Vasos con punta XZN (55mm) M5; M6; M8; M9; M10; M12; M14; M16.
348100 05...18	10-Vasos con punta XZN largos (100mm) M5; M6; M8; M9; M9.5; M10; M12; M14; M16; M18.
348140 08...14	5-Vasos con punta XZN largos (140mm) M8; M9; M10; M12; M14.
348055 14T...16T	2-Vasos con punta XZN inviolable (55mm) M14; M16.
34810016T	1-Vasos con punta XZN inviolable (100mm) M16.
674	1-Vaso con punta XZN M10x110mm para alternador



Juego de puntas de 10MM de 42 piezas

4421	
Ref.	10/21.0/22.0/0.8' 2100g
17430 04...12	Contenido: 14- Puntas allen de 10mm 4; 5; 6; 7; 8; 10; 12 mm de 30mm
17475 04...12	4; 5; 6; 7; 8; 10; 12 mm de 75mm
17630 20...60	16- Puntas Torx de 10mm T20; T25; T30; T40; T45; T50; T55; T60 de 30mm
17675 20...60	T20; T25; T30; T40; T45; T50; T55; T60 de 75mm
17830 05...12	10- Puntas XZN de 10mm M5; M6; M8; M10; M12 x 30mm
17875 05...12	M5; M6; M8; M10; M12 x 75mm
810 37...47	2-Portapuntas 3/8" x 10mm y 1/2" x 10mm



Juego de puntas de 10MM de 44 piezas

4442C	
Ref.	10/22.0/23.0/1' 2200g
17430 04...12	Contenido 3/8" y 1/2" 14-Puntas allen de 10mm 4; 5; 6; 7; 8; 10; 12 mm (30mmL)
17475 04...12	4; 5; 6; 7; 8; 10; 12 mm (75mmL)
17630 20...60	16-Puntas Torx de 10mm T20; T25; T30; T40; T45; T50; T55; T60 (30mmL)
17675 20...60	T20; T25; T30; T40; T45; T50; T55; T60 (75mmL)
17830 05...12	10-Puntas XZN de 10mm M5; M6; M8; M10; M12 (30mm)
17875 05...12	M5; M6; M8; M10; M12 (75mm)
34610070	1-Vaso punta Torx T70 (100mm)
34614055	1-Vaso punta Torx T70 T55 (140mm)
810 37...47	2-Portapuntas 3/8"DR.x10mm; 1/2"DR.x10mm



Juego de vasos de 24 pzs. (MM)

4245-7			
Ref.	Vaso	4/20.7/21.7/0.9'	5175g
547 10...32	Contenido de 1/2" 18-Vasos hexagonales surface drive 10; 11; 12; 13; 14; 15; 16; 17; 18; 19; 20; 21; 22; 23; 24; 27; 30; 32 mm		
80244	1-Carraca de 24 dientes		
8034250	1-Maneral corredizo		
8044 125...250	2-Extensiones de 125 y 250mm		
80541	1-Articulación universal		
8154410A	1-Maneral de giro		



Juego de vasos de 24 pzs. (SAE)

4245S-9			
Ref.	Vaso	4/20.7/21.7/0.9'	5175g
549 5.16...1.1.4	Contenido de 1/2" 18-Vasos poligonales 5/16"; 3/8"; 7/16"; 1/2"; 9/16"; 19/32"; 5/8"; 11/16"; 3/4"; 25/32"; 13/16"; 7/8"; 15/16"; 1"; 1-1/16"; 1/8"; 1-3/16"; 1-1/4"		
80244	1-Carraca de 24 dientes		
8034250	1-Maneral corredizo		
8044 125...250	2-Extensiones de 125 y 250mm		
80541	1-Articulación universal		
8154410A	1-Maneral de giro		



Juego de vasos de 24 pzs. (SAE)

4246S			
Ref.	Vaso	4/20.6/21.6/0.9'	5150g
547 5.16...1.1.4	Contenido de 1/2" 18-Vasos hexagonales 5/16"; 3/8"; 7/16"; 1/2"; 9/16"; 19/32"; 5/8"; 11/16"; 3/4"; 25/32"; 13/16"; 7/8"; 15/16"; 1"; 1-1/16"; 1-1/8"; 1-3/16"; 1-1/4"		
80243	1-Carraca de 24 dientes		
8034250	1-Maneral corredizo		
8044 125...250	2-Extensiones de 125 y 250mm		
80541	1-Articulación universal		
807420.6	1-Vaso para bujías de 20.6mm		



Juego de vasos de 24 pzs. (SAE)

4246S-72			
Ref.	Vaso	4/20.6/21.6/0.9'	5150g
547 5.16...1.1.4	Contenido de 1/2" 18-Vasos hexagonales surface drive 5/16"; 3/8"; 7/16"; 1/2"; 9/16"; 19/32"; 5/8"; 11/16"; 3/4"; 25/32"; 13/16"; 7/8"; 15/16"; 1"; 1-1/16"; 1-1/8"; 1-3/16"; 1-1/4"		
80243	1-Carraca de 72 dientes		
8034250	1-Maneral corredizo		
8044 125...250	2-Extensiones de 125 y 250mm		
80541	1-Articulación universal		
807420.6	1-Vaso para bujías de 20.6mm		



Juego de vasos de 24 pzs. (MM)

4245-9			
Ref.	Vaso	4/20.7/21.7/0.9'	5175g
549 10...32	Contenido de 1/2" 18-Vasos poligonales 10; 11; 12; 13; 14; 15; 16; 17; 18; 19; 20; 21; 22; 23; 24; 27; 30; 32 mm		
80244	1-Carraca de 24 dientes		
8034250	1-Maneral corredizo		
8044 125...250	2-Extensiones de 125 y 250mm		
80541	1-Articulación universal		
8154410A	1-Maneral de giro		



Juego de vasos de 24 pzs. (MM)

4246			
Ref.	Vaso	4/20.6/21.6/0.9'	5150g
547 10...32	Contenido de 1/2" 18-Vasos hexagonales surface drive 10; 11; 12; 13; 14; 15; 16; 17; 18; 19; 20; 21; 22; 23; 24; 27; 30; 32 mm		
80243	1-Carraca de 24 dientes		
8034250	1-Maneral corredizo		
8044 125...250	2-Extensiones de 125 y 250mm		
80541	1-Articulación universal		
807420.6	1-Vaso para bujías de 20.6mm		



Juego de vasos de 24 pzs. (MM)

4246-72			
Ref.	Vaso	4/20.6/21.6/0.9'	5150g
547 10...32	Contenido de 1/2" 18-Vasos hexagonales surface drive 10; 11; 12; 13; 14; 15; 16; 17; 18; 19; 20; 21; 22; 23; 24; 27; 30; 32 mm		
80243	1-Carraca de 72 dientes		
8034250	1-Maneral corredizo		
8044 125...250	2-Extensiones de 125 y 250mm		
80541	1-Articulación universal		
807420.6	1-Vaso para bujías de 20.6mm		



Juego de vasos de 24 pzs. (MM)

4246-72-9			
Ref.	Vaso	4/20.6/21.6/0.9'	5150g
549 10...32	Contenido de 1/2" 18-Vasos poligonales 10; 11; 12; 13; 14; 15; 16; 17; 18; 19; 20; 21; 22; 23; 24; 27; 30; 32 mm		
80243	1-Carraca de 72 dientes		
8034250	1-Maneral corredizo		
8044 125...250	2-Extensiones de 125 y 250mm		
80541	1-Articulación universal		
807420.6	1-Vaso para bujías de 20.6mm		



Juego de vasos de 24 pzs. (SAE)

4246S-72-9			
Ref.	Vaso	4/20.6/21.6/0.9'	5150g
549 5.16...1.1.4	Contenido de 1/2" 18-Vasos poligonales 5/16"; 3/8"; 7/16"; 1/2"; 9/16"; 19/32"; 5/8"; 11/16"; 3/4"; 25/32"; 13/16"; 7/8"; 15/16"; 1"; 1-1/16"; 1-1/8"; 1-3/16"; 1-1/4"		
80243	1-Carraca de 72 dientes		
8034250	1-Maneral corredizo		
8044 125...250	2-Extensiones de 125 y 250mm		
80541	1-Articulación universal		
807420.6	1-Vaso para bujías de 20.6mm		



Juego de vasos de 40 pzs. (MM)

4403-9			
Ref.	Vaso	4/22.1/23.1/0.9'	5530g
549 08...32	Contenido de 3/8" y 1/2": 19-Vasos poligonales 8; 10; 11; 12; 13; 14; 15; 16; 17; 18; 19; 20; 21; 22; 23; 24; 27; 30; 32 mm		
54977 12...17	4-Vasos poligonales largos 12; 13; 15; 17 mm		
344055 06...12	9-Vasos con punta (55mm) Allen 6; 8; 10; 12 mm		
346055 30...55	Torx T30; T40; T45; T50; T55		
80249	1-Carraca de 72dientes		
8044 125...250	2-Extensiones de 125 y 250mm		
80541	1-Articulación universal		
80634	1-Adaptador para extensión 3/8"(H)x1/2"(M)		
8074 16...20.6	3-Vasos para bujías: 16mm; 18mm; 20.6mm		



Juego de vasos de 40 pzs. (MM)

4403			
Ref.	Vaso	4/22.1/23.1/0.9'	5530g
545 08...32	Contenido de 3/8" y 1/2": 19-Vasos hexagonales 8; 10; 11; 12; 13; 14; 15; 16; 17; 18; 19; 20; 21; 22; 23; 24; 27; 30; 32 mm		
54577 12...17	4-Vasos hexagonales largos 12; 13; 15; 17 mm		
344055 06...12	9-Vasos con punta (55mm) Allen 6; 8; 10; 12 mm		
346055 30...55	Torx T30; T40; T45; T50; T55		
80249	1-Carraca de 72dientes		
8044 125...250	2-Extensiones de 125 y 250mm		
80541	1-Articulación universal		
80634	1-Adaptador para extensión 3/8"(H)x1/2"(M)		
8074 16...20.6	3-Vasos para bujías: 16mm; 18mm; 20.6mm		



Juego de vasos de 40 pzs. (MM)

4403S-9			
Ref.	Vaso	4/22.1/23.1/0.9'	5530g
549 08...32	Contenido de 3/8" y 1/2": 19-Vasos poligonales 1/4; 5/16; 3/8; 7/16; 15/32; 1/2; 9/16; 19/32; 5/8; 11/16; 3/4; 25/32; 13/16; 7/8; 15/16; 1; 1.1/16; 1.1/8; 1.1/4"		
54977 12...17	4-Vasos poligonales largos 1/4; 5/16; 3/8; 1/2"		
344055 06...12	9-Vasos con punta (55mm) Allen 6; 8; 10; 12 mm		
346055 30...55	Torx T30; T40; T45; T50; T55		
80249	1-Carraca de 72dientes		
8044 125...250	2-Extensiones de 125 y 250mm		
80541	1-Articulación universal		
80634	1-Adaptador para extensión 3/8"(H)x1/2"(M)		
8074 16...20.6	3-Vasos para bujías: 16mm; 18mm; 20.6mm		



Juego de vasos de 41 pzs. (SAE y MM)

4412-72			
Ref.	Vaso	4/26.6/27.6/0.9'	6650g
549 10...32	Contenido de 1/2". 33-Vasos poligonales 10; 11; 12; 13; 14; 15; 16; 17; 18; 19; 20; 21; 22; 23; 24; 27; 30; 32 mm		
549 3.8...1.1.4	3/8"; 7/16"; 1/2"; 9/16"; 5/8"; 11/16"; 3/4"; 13/16"; 7/8"; 15/16"; 1"; 1-1/16"; 1-1/8"; 1-3/16"; 1-1/4"		
80242	1-Carraca		
8044 125...250	2-Extensiones de 125 y 250mm		
8074 16...20.6	2-Vasos para bujías: 16; 20.6 mm		
8034250	1-Maneral corredizo		
80541	1-Articulación universal		
8154410A	1-Maneral de giro		



Juego de herramientas de 60 pzs. (MM)

4602		
Ref..	3/17.0/18.0/1.7"	5666g
Contenido de 1/4" y 1/2":		
1/4":		
525 04...10	7-Vasos hexagonales 4; 5; 6; 7; 8; 9; 10 mm	
8143	1-Destornillador portavasos de 1/4"	
80222	1-Carraca de 1/4" de 24 dientes	
81022	1-Vaso portapuntas de 1/4"(H)x1/4"	
12330 04...065	3-Puntas planas de 1/4" 4; 5.5; 6.5 mm	
12630 10...40	7-Puntas Torx de 1/4" T10; T15; T20; T25; T27; T30; T40	
12130 1...3	3-Puntas Phillips PH.1; PH.2; PH.3	
12430 03...06	4-Puntas Allen 3; 4; 5; 6 mm	
1/2":		
545 10...27	11-Vasos hexagonales de 1/2" 10; 11; 12; 13; 14; 15; 17; 19; 22; 24; 27 mm	
8044125	1-Extensión de 5"	
80541	1-Articulación universal de 1/2"	
80243	1-Carraca de 1/2" de 24 dientes	
8074 16...20.6	2-Vasos para bujías; 16; 20.6 mm	
Otros:		
755 11...17	6-Llaves combinadas 11; 12; 13; 14; 15; 17 mm	
613B250	1-Llave de pico de loro de 250mm	
611B175	1-Alicates universales 180mm	
764 015...025	3-Llaves Allen de 1.5; 2; 2.5 mm	
616300	1-Martillo de mecánico de 300g	
7112S	1-Destornillador Phillips corto PH.2 x 25mm	
713065S	1-Destornillador plano corto 6.5 x 25mm	
711 1...2	2-Destornilladores Phillips PH.1x80mm; PH.2x100mm	
713065	1-Destornillador plano 6.5 x 1 50mm	



Juego de vasos de 61 pzs. (MM)

4611-72			
Ref.	Vaso	3/20.3/21.3/1"	6760g
Contenido de 1/4" y 1/2":			
1/4":			
529 04...10	8-Vasos poligonales de 1/4" 4; 5; 5.5; 6; 7; 8; 9; 10 mm		
52950 08...10	2-Vasos poligonales largos de 1/4" 8 y 10 mm		
11-Vasos con punta de 32mm			
32432 04...06	Allen 4; 5; 6 mm		
32632 10...30	Torx T10; T20; T25; T30		
32132 1...2	Phillips PH.1; PH.2		
32332 04...055	Plano 4; 5.5 mm		
80229	1-Carraca de 72 dientes de 1/4"		
8042 050...150	2-Extensiones de 50 y 150mm		
80521	1-Articulación universal de 1/4"		
8142	1-Destornillador portavasos de 1/4"		
764 0127...025	4-Llaves allen 1.27; 1.5; 2; 2.5 mm		
1/2":			
549 10...32	12-Vasos poligonales de 1/2" 10; 11; 12; 13; 14; 15; 17; 19; 22; 24; 30; 32 mm		
54977 12...17	Vasos poligonales largos de 1/2" 12; 13; 17 mm		
344100 07...10	3-Vasos de 1/2" con punta allen 7; 8; 10 mm (100mm)		
346055 40...50	3-Vaso punta Torx T40; T45; T50		
341553	1-Vaso punta Phillips PH.3		
34305508	1-Vaso punta plana 8 mm		
80249	1-Carraca de 72 dientes de 1/2"		
8074 16...20.6	2-Vasos para bujías: 16; 20.6 mm		
8044125	1-Extensión de 1/2" de 125mm		
808410	1-Extensión de 1/2" de 250mm		
8034250	1-Maneral corredizo de 1/2"		
80541	1-Articulación universal de 1/2"		



Juego de vasos de 61 pzs. (SAE)

4611S-72			
Ref.	Vaso	3/20.3/21.3/1"	6760g
Contenido de 1/4" y 1/2":			
1/4":			
529 04...10	8-Vasos poligonales de 1/4" 3/16; 7/32; 1/4; 9/32; 5/16; 11/32; 3/8; 7/16"		
52950 08...10	2-Vasos poligonales largos de 1/4" 1/4 y 3/8"		
11-Vasos con punta de 32mm			
32432 04...06	Allen 5/32 y 3/16"		
32632 10...30	Torx T10; T20; T25; T30		
32132 1...2	Phillips PH.1; PH.2		
32332 04...055	Plano 4; 5.5 mm		
80229	1-Carraca de 72 dientes de 1/4"		
8042 050...150	2-Extensiones de 50 y 150mm		
80521	1-Articulación universal de 1/4"		
8142	1-Destornillador portavasos de 1/4"		
764 0127...025	4-Llaves allen 1.27; 1.5; 2; 2.5 mm		
1/2":			
549 10...32	12-Vasos poligonales de 1/2" 7/16; 15/32; 1/2; 9/16; 19/32; 5/8; 11/16; 3/4; 13/16; 15/16; 1.1/8; 1.1/4"		
54977 12...17	3-Vasos poligonales largos de 1/2" 1/2; 9/16; 5/8"		
344100 07...10	3-Vasos de 1/2" con punta allen 1/4; 5/16; 3/8" (100mm)		
346055 40...50	3-Vaso punta Torx T40; T45; T50		
341553	1-Vaso punta Phillips PH.3		
34305508	1-Vaso punta plana 8 mm		
80249	1-Carraca de 72 dientes de 1/2"		
8074 16...20.6	2-Vasos para bujías: 16; 20.6 mm		
8044125	1-Extensión de 1/2" de 125mm		
808410	1-Extensión de 1/2" de 250mm		
8034250	1-Maneral corredizo de 1/2"		
80541	1-Articulación universal de 1/2"		



Juego de vasos de 65 pzs.

4652		
Part no.	2/28.5/29.5/0.77"	14.2kg
Contenido de 1/4", 1/2" y 3/4":		
1/4":		
12-Vasos hexagonales 4; 5.5; 6; 7; 8; 9; 10; 11; 12 mm		
525 04...12	4; 5.5; 6; 7; 8; 9; 10; 11; 12 mm	
525 3.16...3.8	3/16"; 1/4"; 3/8"	
80222	1-Carraca de 1/4"	
8012140	1-Maneral basculante de 1/4"	
8032115	1-Maneral corredizo de 1/4"	
8143	1-Destornillador portavasos de 1/4"	
8042 050...150	2-Extensiones de 50; 150 mm	
80521	1-Articulación universal de 1/4"	
8032115A	1-Maneral de 1/4"	
1/2":		
26-Vasos hexagonales de 1/2" 8; 9; 10; 11; 12; 13; 14; 15; 16; 17; 19; 20; 21; 22; 23; 24; 26; 27; 29; 30; 32 mm		
545 08...32	8; 9; 10; 11; 12; 13; 14; 15; 16; 17; 19; 20; 21; 22; 23; 24; 26; 27; 29; 30; 32 mm	
545 3.8...1	3/8"; 1/2"; 9/16"; 11/16"; 1"	
80242	1-Carraca de 1/2"	
8014380	1-Maneral basculante de 375mm	
8034250	1-Maneral corredizo de 1/2"	
8044 075...250	3-Extensiones de 75; 125; 250 mm	
80541	1-Articulación universal de 1/2"	
8034150A	1-Maneral de 1/2" de 150mm	
3/4":		
9-Vasos poligonales de 3/4" 26; 27; 29; 30; 32; 35; 36; 38; 41 mm		
569 26...41	26; 27; 29; 30; 32; 35; 36; 38; 41 mm	
8026500	1-Carraca de 3/4" de 500 mm	
8046200	1-Extensión de 3/4" de 200 mm	



Juego de herramientas de 83 Pzs.

Ref.	Hex.	2/18.8/19.8/1.54'	9392g
4832			
Contenido de 1/4" y 1/2":			
1/4":			
525 04...13		10-Vasos hexagonales de 1/4"	
		4; 5; 6; 7; 8; 9; 10; 11; 12; 13 mm	
52550 05...10		5-Vasos hexagonales largos de 1/4"	
		5; 6; 7; 8; 10 mm	
80222		1-Carraca de 1/4" de 24 dientes	
8042100		1-Extensión de 100mm	
8143		1-Destornillador portavasos de 1/4"	
80521		1-Articulación universal de 1/4"	
81022		1-Vaso portapuntas 1/4"(H)x1/4"	
12630 08...40		8-Puntas de 1/4" Torx	
		T8; T10; T15; T20; T25; T27; T30; T40	
12430 03...06		4-Puntas Allen de 1/4"	
		3; 4; 5; 6 mm	
12330 04...065		3-Puntas planas de 1/4"	
		4; 5.5; 6.5 mm	
12130 1...3		3-Puntas Phillips de 1/4"	
		PH.1; PH.2; PH.3	
12230 1...3		3- Puntas Pozidriv de 1/4"	
		PZ.1; PZ.2; PZ.3	
8092230		1-Adaptador 1/4"Hex-1/4" cuadrado	
1/2":			
545 10...32		13-Vasos hexagonales de 1/2"	
		10; 11; 12; 13; 14; 15; 17; 19;	
		22; 24; 27; 30; 32 mm	
8334300		1-Carraca extensible de 1/2"	
802433		1-Empuñadura para carraca extensible	
803A4300		1-Maneral corredizo	
815A4315		1-Manerla en L de 105°	
8044125		1-Extensión de 125mm de 1/2"	
80541		1-Articulación universal de 1/2"	
8074 16...20.6		2-Vasos para bujías: 16; 20.6 mm	



Juego de 91 herramientas Torx

Ref.	Torx	2/11.7/12.7/0.77'	5850g
4921			
Contenido de 1/4" y 1/2":			
756		6-Llaves Torx hembra acodadas	
		E6xE8; E7xE11; E10xE12;	
		E14xE18; E16xE22; E20xE24	
0608A...2024A		14-Llaves Torx	
		T6; T7; T8; T9; T10; T15; T20;	
		T25; T27; T30; T40; T45; T50; T55	
766 06...55		1-Destornillador Torx T6	
71606		10-Destornilladores Torx Inviolable	
		T-7H; T-8H; T-9H; T-10H; T-15H;	
		T-20H; T-25H; T-27H; T-30H;	
		T-40H;	
717 07...40		14-Vasos Torx hembra	
		1/4": E4; E5; E6; E7; E8; E10; E11	
		1/2": E12; E14; E16; E18; E20;	
		E22; E24	
526 04...11		4-Vasos con punta Torx de 1/2"	
		T55 (140mm)	
546 12...24		T60 (55mm)	
		T70 (100mm)	
		T80 (70mm)	
34614055		3-Puntas Torx de 1/4"	
34605560		T6; T7 (25mm)	
34610070		T25 (65mm)	
34607080		10-Puntas Torx inviolable de 1/4" (25mm)	
		T-8H; T-9H; T-10H; T-15H; T-20H;	
		T-25H; T-27H; T-30H; T-35H;	
		T-40H	
12625 06...07		8-Puntas Torx de 10mm	
1266525		T47 (30mm)	
12725 08...40		T40; T45; T50 (75mm)	
		T-40H; T45H; T-50H;	
		T-55H (30mm)	
2763047		2-Vasos portapuntas	
17675 40...50		1/4"x1/4"(H); 1/2"x10mm	
17730 40...55		20-Comprobadores de medida Torx	
810 22...47			
5201			



94pc Combination set

Ref.	Hex.	3/21.0/22.0/1'	7000g
4941-5			
Contenido de 1/4" y 1/2":			
1/4":			
525 04...14		13-Vasos hexagonales de 1/4"	
		4; 4.5; 5; 5.5; 6; 7; 8; 9; 10; 11; 12;	
		13; 14 mm	
52550 06...13		Vasos hexagonales largos de 1/4"	
		6; 7; 8; 9; 10; 11; 12; 13; (50mm)	
32432 03...06		18-Vasos con punta (32mm)	
32632 08...30		Allen 3; 4; 5; 6 mm	
		Torx T8; T10; T15; T20; T25;	
		T27; T30	
32332 04...065		Plano 4; 5.5; 6.5 mm	
32132 1...2		Phillips PH.1; PH.2	
32232 1...2		Pozidriv PZ.1; PZ.2	
80222		1-Carraca de 1/4"	
8042 050...100		2-Extensiones de 50 y 100mm	
8032115		1-Maneral corredizo	
80521		1-Articulación universal	
8143		1-Destornillador portavasos	
764 015...025		3-llaves Allen 1.5; 2; 2.5 mm	
1/2":			
545 10...32		17-Vasos hexagonales de 1/2"	
		10; 11; 12; 13; 14; 15; 16; 17; 18;	
		19; 20; 21; 22; 24; 27; 30; 32 mm	
54577 14...22		5-Vasos hexagonales largos de 1/2"	
		14; 15; 17; 19; 22; (77mm)	
		16-Puntas de 5/16" (30mm)	
		Allen 7; 8; 10; 12; 14 mm	
15430 07...14		Torx T40; T45; T50; T55	
15630 40...55			

Ref.	Hex.	3/21.0/22.0/1'	7000g
4941-5			
15330 08...12		Plano 8; 10; 12 mm	
15130 3...4		Phillips PH.3; PH.4	
15230 3...4		Pozidriv PZ.3; PZ.4	
80242		1-Carraca de 1/2"	
8074 16...20.6		2-Vasos para bujías 16; 20.6mm	
8044 125...250		2-Extensiones de 125 y 250mm	
80541		1-Articulación universal de 1/2"	
81045		1-Portapuntas de 1/2".x 5/16"	
80634		1-Adaptador para extensión 3/8".x1/2"(M)	



Juego de vasos de 108 pzs.

41082	Surface	3/22.8/23.8/1.7'	7600g
Ref.	Surface	3/22.8/23.8/1.7'	7600g
	Contenido de 1/4" y 1/2"		
	1/4":		
527 04...14	13-Vasos hexagonales de 1/4" 4; 4.5; 5; 5.5; 6; 7; 8; 9; 10; 11; 12; 13; 14 mm		
52750 06...13	8- Vasos hexagonales largos de 1/4" 6; 7; 8; 9; 10; 11; 12; 13 (50mm)		
526 04...08	5- Vasos Torx hembra de 1/4" E4; E5; E6; E7; E8		
	18-Vasos con punta (32mm)		
32432 03...06	Allen 3; 4; 5; 6		
32632 08...30	Torx T8; T10; T15; T20; T25; T27; T30		
32332 04...065	Plano 4; 5.5; 6.5		
32132 1...2	Phillips PH.1; PH.2		
32232 1...2	Pozidriv PZ.1; PZ.2		
80222	1- Carraca de 1/4"		
8042 050...100	2- Extensiones de 50 y 100mm		
8032115	1- Maneral corredizo de 1/4"		
80521	1- Articulación universal de 1/4"		
8143	1- Destornillador portavasos de 1/4"		
764 015...025	3- Llaves allen de: 1.5; 2; 2.5		
	1/2":		
547 10...32	17-Vasos hexagonales de 1/2" 10; 11; 12; 13; 14; 15; 16; 17; 18; 19; 20; 21; 22; 24; 27; 30; 32 mm		
54777 14...22	5- Vasos hexagonales largos de 1/2" 14; 15; 17; 19; 22 (77mm)		

41082	Surface	3/22.8/23.8/1.7'	7600g
Ref.	Surface	3/22.8/23.8/1.7'	7600g
546 10...24	8- Vasos Torx hembra de 1/2" E10; E11; E12; E14; E16; E18; E20; E24		
	17-Puntas de 5/16" (30mm)		
15430 07...14	Allen 7; 8; 10; 12; 14		
15630 40...60	Torx T40; T45; T50; T55; T60		
15330 08...12	Plano 8; 10; 12		
15130 3...4	Phillips PH.3; PH.4		
15230 3...4	Pozidriv PZ.3; PZ.4		
80242	1- Carraca de 1/2"		
8074 16...20.6	2- Vaso para bujías 16; 20.6mm		
8044125W	1- Extensión de 125mm de bola		
8044250	1- Extensión de 250mm		
80541	1- Articulación universal de 1/2"		
81045	1- Vaso portapuntas 1/2".x5/16"		
80634	1- Adaptador para extension 3/8"x1/2"(M)		



Juego de herramientas de 110 Pzs.

41101	Surface	3/22.8/23.8/1.7'	7600g
Ref.	Surface	3/22.8/23.8/1.7'	7600g
	Contenido de 1/4" y 1/2"		
	1/4":		
525 04...13	10-Vasos hexagonales de 1/4" 4; 5; 6; 7; 8; 9; 10; 11; 12; 13 mm		
80222	1-Carraca de 1/4"		
8042 050...100	2-Extensiones de 50 y 100mm		
80521	1-Articulación universal de 1/4"		
8111	1-Extensión flexible de 145mm		
8143	1-Destornillador portavasos de 1/4"		
81022	1-Vaso portapuntas 1/4"(H)x1/4" hex		
12330 03...065	4-Puntas planas 3; 4; 5.5; 6.5 mm		
12630 08...30	7-Puntas Torx T8; T10; T15; T20; T25; T27; T30		
12130 0...2	3-Puntas Phillips PH.0; PH.1; PH.2		
12430 03...06	4-Puntas Allen 3; 4; 5; 6 mm		
12230 1...2	2-Puntas Pozidriv PZ.1; PZ.2		

41101	Surface	3/22.8/23.8/1.7'	7600g
Ref.	Surface	3/22.8/23.8/1.7'	7600g
545 10...32	18-Vasos hexagonales de 1/2" 10; 11; 12; 13; 14; 15; 16; 17; 18; 19; 20; 21; 22; 23; 24; 27; 30; 32 mm		
546 10...24	8-Vasos Torx hembra de 1/2" E10; E11; E12; E14; E16; E18; E20; E24		
80243	1-Carraca de 1/2"		
8044 075...250	2-Extensiones de 75 y 250mm		
8014380	1-Maneral basculante de 375mm		
80541	1-Articulación universal de 1/2"		
8074 16...20.6	2-Vaso para bujías 16; 20.6mm		
81045	1-Vaso portapuntas 1/2"(H)x5/16"(H)		
15470 07...14	5-Puntas Allen 7; 8; 10; 12; 14 mm		
15330 08...12	3-Puntas planas 8; 10; 12 mm		
15130 3...4	2-Puntas Phillips PH.3; PH.4		
15230 3...4	2-Puntas Pozidriv PZ.3; PZ.4		
15630 40...55	4-Puntas Torx T40; T45; T50; T55		
	Otros:		
755 06...27	16-Llaves combinadas 6; 7; 8; 9; 10; 11; 12; 13; 14; 15; 16; 17; 19; 22; 24; 27 mm		
613B250	1-Llave de pico de loro de 250mm		
611B175	1-Alicate universal de 180mm		
616300	1-Martillo de mecánico de 300g		
7112S	1-Destornillador Phillips corto PH.2 (25mm)		
713065S	1-Destornillador plano corto 6.5mm (25mm)		
7112	1-Destornillador Phillips PH.2(100mm)		
713065	1-Destornillador plano 6.5mm(150mm)		



Juego de herramientas de 142 Pzs.

Ref.	Hex	2/26.0/27.0/1.54'	13kg
41421-7	Hex	2/26.0/27.0/1.54'	13kg
Content: 1/4" & 3/8" & 1/2"DR.			
1/4":			
26-Puntas de 1/4" (30mm)			
12130 0...3	Phillips PH.0; PH.1; PH.2; PH.3		
12230 0...3	Pozidriv PZ.0; PZ.1; PZ.2; PZ.3		
12330 04...07	Planas 4; 5.5; 7 mm		
12430 02...10	Allen 2; 3; 4; 5; 6; 7; 8; 10 mm		
12730 10...40	Torx inviolable T-10H; T15H; T-20H; T-25H; T-27H; T-30H; T-40H		
525 04...10	9-Vasos hexagonales de 1/4" 4; 4.5; 5; 5.5; 6; 7; 8; 9; 10 mm		
526 04...08	5-Vasos Torx hembra de 1/4" E4; E5; E6; E7; E8 mm		
80222	1-Carraca de 1/4"		
8042 050...150	3-Extensiones de 50, 100 y 150mm		
80521	1-Articulación universal de 1/4"		
80632	1-Reducción de 3/8"(H) x 1/4"(M)		
81022	1-Vaso portapuntas		
8111	1-Extensión flexible de 1/4"		
8143	1-Destornillador portavasos de 1/4"		
3/8":			
539 06...22	15-Vasos poligonales de 3/8" 6; 7; 8; 9; 10; 11; 12; 13; 14; 15; 17; 18; 19; 21; 22 mm		
802318	1-Carraca articulada de 3/8"		
8043 075...150	2-Extensiones de 75 y 150mm		
80531	1-Articulación universal de 3/8"		

Ref.	Hex	2/26.0/27.0/1.54'	13kg
41421	Hex	2/26.0/27.0/1.54'	13kg
1/2":			
545 08...32	19-Vasos hexagonales de 1/2" 8; 10; 12; 13; 14; 15; 16; 17; 18; 19; 20; 21; 22; 23; 24; 25; 27; 30; 32 mm		
546 10...20	5-Vasos Torx hembra de 1/2" E10; E12; E14; E16; E20 mm		
8014430	1-Maneral basculante 17" (430mmL)		
80243	1-Carraca de 1/2"		
8044 075...250	2-Extensiones de 75 y 250mm		
80541	1-Articulación universal de 1/2"		
80634	1-Ampliación 3/8"(H) x 1/2"(M)		
8074 16...20.6	2-Vasos para bujías 16 ; 20.6 mm		
8154260	1-Maneral en L de 260mm		
Otros:			
755 06...24	17-Llaves combinadas 6; 7; 8; 9; 10; 11; 12; 13; 14; 15; 16; 17; 18; 19; 21; 22; 24 mm		
751 0810...1719	5-Llaves para racores 8x10; 10x12; 11x13; 12x14; 17x19 mm		
764 025...14	10-Llaves allen 2.5; 3; 4; 5; 6; 7; 8; 10; 12; 14 mm		
616300	1-Martillo de mecánico de 300g.		
611B175	1-Alicate universal de 180mm		
614250	1-Mordaza grip de 250mm		
7111S	1-Destornillador Phillips corto PH.1		
7112	1-Destornillador Phillips PH.2		
7112M	1-Destornillador Phillips de golpe PH.2		
713055S	1-Destornillador plano corto 5.5mm x 25mm		
713065	1-Destornillador plano 6.5mm x 150mm		
713065M	1-Destornillador plano de golpe 6.5mm x 150mm		



Puntas Allen de 10mm

Ref.	Medida	mm	g	ud/caja
174	○	l	⚖	📦
1743004	4	30	13	10
1743005	5	30	14	10
1743006	6	30	14	10
1743007	7	30	16	10
1743008	8	30	17	10
1743010	10	30	20	10
1743012	12	30	25	10
1743014	14	30	27	10
1747504	4	75	43	10
1747505	5	75	43	10
1747506	6	75	44	10
1747507	7	75	45	10
1747508	8	75	47	10
1747510	10	75	50	10
1747512	12	75	67	10

Puntas Torx de 10mm

Ref.	Medida	mm	g	ud/caja
176	⊛	l	⚖	📦
1763010	T10	30	12	10
1763015	T15	30	12	10
1763020	T20	30	13	10
1763025	T25	30	13	10
1763027	T27	30	14	10
1763030	T30	30	14	10
1763040	T40	30	15	10
1763045	T45	30	16	10
1763050	T50	30	16	10
1763055	T55	30	18	10
1763060	T60	30	22	10
1767510	T10	75	41	10
1767515	T15	75	41	10
1767520	T20	75	42	10
1767525	T25	75	42	10
1767527	T27	75	42	10
1767530	T30	75	43	10
1767540	T40	75	44	10
1767545	T45	75	45	10
1767550	T50	75	45	10
1767555	T55	75	48	10
1767560	T60	75	64	10



Puntas XZN de 10mm

Ref.	Medida	mm	g	ud/caja
178	○	l	⚖	📦
1783005	M5	30	13	10
1783006	M6	30	14	10
1783008	M8	30	15	10
1783010	M10	30	17	10
1783012	M12	30	20	10
1787505	M5	75	43	10
1787506	M6	75	43	10
1787508	M8	75	44	10
1787510	M10	75	47	10
1787512	M12	75	58	10



Puntas Ribe de 10mm

Ref.	Medida	l mm	g	ud/caja
1793004	M4	30	14	10
1793005	M5	30	14	10
1793006	M6	30	14	10
1793007	M7	30	14	10
1793008	M8	30	14	10
1793009	M9	30	18	10
1793010	M10	30	18	10
1793012	M12	30	20	10
1793013	M13	30	22	10
1793014	M14	30	24	10
1797504	M4	75	42	10
1797505	M5	75	42	10
1797506	M6	75	42	10
1797507	M7	75	42	10
1797508	M8	75	44	10
1797509	M9	75	46	10
1797510	M10	75	47	10
1797512	M12	75	63	10
1797513	M13	75	78	10
1797514	M14	75	79	10



Vaso con punta Allen de 1/2"

Ref.	Medida	l mm	g	ud/caja
34411005	5	110	85	10
34411006	6	110	85	10
34411007	7	110	91	101
34411008	8	110	93	0
34411010	10	110	117	10
34411012	12	110	162	10
34411014	14	110	207	10
34411017	17	110	274	10
34411019	19	110	331	10

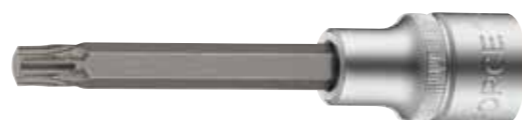

Vaso con punta Torx de 1/2"

Ref.	Medida	l mm	g	ud/caja
34605520	T20	55	62	10
34605525	T25	55	63	10
34605527	T27	55	63	10
34605530	T30	55	63	10
34605540	T40	55	64	10
34605545	T45	55	67	10
34605550	T50	55	68	10
34605555	T55	55	79	10
34605560	T60	55	101	10
34605570	T70	55	132	10
34610070	T70	100	191	10



Vaso con punta Allen de 1/2"

Ref.	Medida	l mm	g	ud/caja
34405504	4	55	62	10
34405505	5	55	64	10
34405506	6	55	65	10
34405507	7	55	68	10
34405508	8	55	69	10
34405509	9	55	79	10
34405510	10	55	80	10
34405512	12	55	103	10
34406514	14	65	149	10
34407017	17	70	196	10
34407019	19	70	235	10



Vaso con punta XZN de 1/2"

Ref.	Medida	l mm	g	ud/caja
34805505	M5	55	67	10
34805506	M6	55	67	10
34805508	M8	55	67	10
34805510	M10	55	78	10
34805512	M12	55	100	10
34805514	M14	55	131	10
34805516	M16	55	162	10
34810006	M6	100	85	10
34810008	M8	100	87	10
34810009	M9	100	95	10
34810009.5	M9.5	100	95	10
34810010	M10	100	108	10
34810012	M12	100	151	10
34810014	M14	100	187	10
34810016	M16	100	242	10
34880008	M8	800	610	10
34880010	M10	800	616	10

* 34880008, 34880010

Largo especial de 800mm para acceder a los palieres de vehículos AUDI/VW.



Vaso hexagonal de 1/2"

Ref.	Medida	l mm	g	ud/caja
54508	8	38	50	10
54509	9	38	50	10
54510	10	38	52	10
54511	11	38	52	10
54512	12	38	53	10

Ref.	Medida	l mm	g	ud/caja
54513	13	38	53	10
54514	14	38	55	10
54515	15	38	55	10
54516	16	38	59	10
54517	17	38	65	10
54518	18	38	78	10
54519	19	38	79	10
54520	20	38	81	10
54521	21	38	95	10
54522	22	38	96	10
54523	23	40	116	10
54524	24	40	117	10
54525	25	43	119	10
54526	26	43	138	10
54527	27	43	144	10
54528	28	43	162	10
54529	29	43	162	10
54530	30	45	173	10
54532	32	45	176	10
5453.8	3/8"	38	53	10
5457.16	7/16"	38	53	10
5451.2	1/2"	38	54	10
5459.16	9/16"	38	55	10
5455.8	5/8"	38	60	10
54511.16	11/16"	38	63	10
5453.4	3/4"	38	70	10
54525.32	25/32"	38	79	10
54513.16	13/16"	38	79	10
5457.8	7/8"	38	96	10
54515.16	15/16"	40	109	10
5451.0	1"	43	140	10
5451.1.16	1-1/16"	43	144	10
5451.1.8	1-1/8"	45	147	10
5451.3.16	1-3/16"	45	168	10
5451.1.4	1-1/4"	45	184	10



Vaso poligonal de 1/2"

549	●	l	⚖	📦
Ref.	Medida	mm	g	ud/caja
54910	10	38	51	10
54911	11	38	52	10
54912	12	38	52	10
54913	13	38	52	10
54914	14	38	54	10
54915	15	38	53	10
54916	16	38	58	10
54917	17	38	64	10
54918	18	38	80	10
54919	19	38	81	10
54920	20	38	86	10
54921	21	38	94	10
54922	22	38	94	10
54923	23	40	108	10
54924	24	40	108	10
54925	25	43	117	10
54926	26	43	124	10
54927	27	43	135	10
54928	28	43	138	10
54929	29	43	165	10
54930	30	45	168	10
54932	32	45	176	10



Vaso poligonal largo de 1/2"

54977	●	l	⚖	📦
Ref.	Medida	mm	g	ud/caja
5497710	10	77	71	10
5497711	11	77	76	10
5497712	12	77	84	10
5497713	13	77	93	10
5497714	14	77	100	10
5497715	15	77	100	10
5497716	16	77	100	10
5497717	17	77	117	10
5497718	18	77	143	10
5497719	19	77	149	10
5497720	20	77	154	10
5497721	21	77	183	10
5497722	22	77	193	10
5497723	23	77	212	10
5497724	24	77	248	10
5497725	25	77	239	10
5497726	26	77	275	10
5497727	27	77	270	10
5497728	28	77	300	10
5497729	29	77	281	10
5497730	30	77	290	10
5497732	32	77	303	10



Carraca de 24 dientes de 1/2"

80242	l	⚖	📦
Ref.	mm	g	ud/caja
80242	270	754	1

* 80242-P: Repuesto



Carraca de 24 dientes de 1/2"

802411	l	⚖	📦
Ref.	mm	g	ud/caja
802411	260	832	1



Carraca de 72 dientes de 1/2"

80249	l	⚖	📦
Ref.	mm	g	ud/caja
80249	264	524	1

* 80249-P: Repuesto



Carraca de 72 dientes de 1/2" articulada

802423	l	⚖	📦
Ref.	mm	g	ud/caja
802423	303	656	1



Carraca de 36 dientes de 1/2" extensible

802433	📦	l	⚖
Ref.	Envase	mm	g
802433	20/15.3/16.3/0.5"	330	765

Combinación:

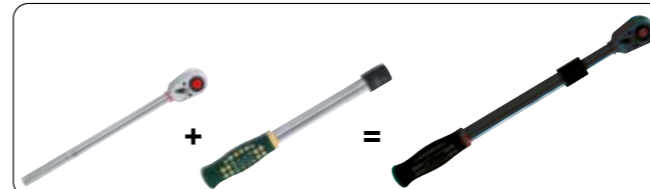

Empuñadura para carraca extensible 802433

8334300	l	⚖	📦
Ref.	mm	g	ud/caja
8334300	310	496	2



Extensiones de 1/2"

8044	l	⚖	📦
Ref.	mm	g	ud/caja
8044075	75-3"	141	150
8044125	125-5"	225	100
8044250	250-10"	438	50



Extensión de bola de 1/2"

8044..W	l	⚖	📦
Ref.	mm	g	ud/caja
8044050W	50-2"	92	10



Juego de 4 extensiones de 1/2"

K4044	📦	⚖
Ref.	Envase	g
8044 050W...250W	12/14.5/15.5/1.4'12/14.5/15 Contenido de 1/2": 4-Extensiones de bola de 1/2" 40, 125, 200 y 250mm	1000



Maneral corredizo de 1/2"

8034300	<i>l</i>		
Ref.	mm	g	ud/caja
8034300	300-12"	445	10



Vasos portapuntas de 1/2"

8104		<i>l</i>		
Ref.	Medida	mm	g	ud/caja
81045	1/2"(H) x 5/16"(H)	38	57	10
81047	1/2"(H) x 10mm(H)	38	57	10

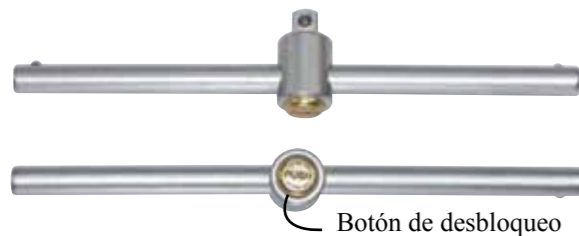

Botón de desbloqueo

Maneral corredizo de 1/2" con bloqueo

8034250L	<i>l</i>		
Ref.	mm	g	ud/caja
8034250L	250-10"	357	10



Articulación universal de 1/2"

80541	<i>l</i>		
Ref.	mm	g	ud/caja
80541	70	149	10



Adaptadores de 1/2"

8094		<i>l</i>		
Ref.	Medida	mm	g	ud/caja
80943	1/2"(H) x 3/8"(M)	36	65	10
80946	1/2"(H) x 3/4"(M)	50	163	10



Juego de vasos de 14 pzs. de 3/4"

Ref.	Poligonal	1/11.0/12.0/0.46'	11kg
6141			
569 22...50	Contenido de 3/4": 10- Vasos poligonales de 3/4" 22; 24; 27; 30; 32; 36; 38; 41; 46; 50 mm		
8026500	1- Carraca de 3/4" de 500mm		
8036450	1- Maneral corredizo de 3/4" 450mm		
8046 100...200	2- Extensiones de 100 y 200m		



Juego de vasos de 20 pzs. de 3/4" (MM)

Ref.	Poligonal	1/12.5/13.5/0.5'	12.5kg
6201			
569 19...50	Contenido de 3/4": 16- Vasos poligonales de 3/4" 19; 21; 22; 23; 24; 26; 27; 29; 30; 32; 35; 36; 38; 41; 46; 50mm		
8026500	1- Carraca de 3/4" de 500mm		
8036450	1- Maneral corredizo de 3/4" 450mm		
8046 100...200	2- Extensiones de 100 y 200mm		



Juego de vasos de 20 pzs. de 3/4" (SAE)

Ref.	Socket	1/12.5/13.5/0.5'	12.5kg
6201S			
569 7.8...2.0	Contenido de 3/4": 16- 12pt. Flank socket 7/8"; 15/16"; 1"; 1-1/16; 1-1/8"; 1-3/16"; 1-1/4"; 1-5/16"; 1-3/8"; 1-7/16"; 1-1/2"; 1-5/8"; 1-3/4"; 1-13/16"; 1-7/8"; 2"		
8026500	1- Carraca de 3/4" de 500mm		
8036450	1- Maneral corredizo de 3/4" 450mm		
8046 100...200	2- Extensiones de 100 y 200m		



Adaptadores de 3/4

Ref.	Medidas	mm	g	ud/caja
8096				
80964	3/4"(H)x1/2"(M)	58	308	5
80968	3/4"(H)x1"(M)	68	407	2



Vasos hexagonales de 3/4"

Ref.	Medida	mm	g	ud/caja
565				
56540	40	62	500	2
56542	42	64	580	2



Vasos poligonales de 3/4"

Ref.	Medida	mm	g	ud/caja
569				
56919	19	50	176	2
56921	21	50	179	2
56922	22	50	222	2
56923	23	50	227	2
56924	24	51	230	2
56925	25	52	238	2
56926	26	52	249	2
56927	27	52	249	2
56928	28	52	259	2
56929	29	52	268	2
56930	30	54	280	2
56932	32	56	294	2
56933	33	56	330	2
56934	34	56	350	2
56935	35	58	394	2
56936	36	58	420	2
56938	38	60	481	2
56941	41	64	540	2
56946	46	68	677	2
56950	50	72	814	2
56955	55	76	949	2
56956	56	76	1000	2
56960	60	78	1013	2
56965	65	82	1100	2



Carraca de 3/4" de 500mm

Ref.	mm	g	ud/caja
8026500			
8026500	500-20"	1970	10



Carraca de 3/4" de 150mm 40 Dientes

Ref.	mm	g	ud/caja
8026150			
8026150	150-20"	1970	10



Maneral corredizo de 3/4"

Ref.	mm	g	ud/caja
8036450			
8036450	450-18"	1388	10



Extensiones de 3/4"

Ref.	mm	g	ud/caja
8046			
8046125	125-5"	505	40
8046200	200-8"	740	30
8046400	400-16"	1358	15



Carraca de 72 dientes de 3/4"

Ref.	mm	g	ud/caja
8026505			
8026505	500	2800	10



Juego de vaso de 1" de 14 pzs. (MM)

8141			
Ref.	Socket	1/26.8/27.8/0.83'	26.8kg
589 36...80	Contenido de 1": 10-Vasos poligonales de 1": 36; 41; 46; 50; 55; 60; 65; 70; 75; 80 mm		
80281	1- Carraca de 1" (Cabeza Ref: 8028650)		
80381	1- Adaptador para maneral corredizo		
8008550	1-Empuñadura de 550mm		
8048 200...400	2-Extensiones de 200 y 400mm		



Maneral corredizo de 1"

8038550	<i>l</i>		
Ref.	mm	g	pc/box
8038550	550-22"	3288	5



Extensiones de 1"

8048	<i>l</i>		
Ref.	mm	g	ud/caja
8048200	200-8"	1330	12
8048400	400-16"	2290	10



1"DR. 12pt. Flank socket

589		<i>l</i>		
Ref.	Medida	mm	g	ud/caja
58954	54	80	1100	2
58955	55	80	1204	2
58960	60	84	1401	2
58965	65	87	1632	2
58967	67	90	1654	1
58970	70	93	2048	1
58975	75	97	2278	1
58980	80	103	2390	1
58985	85	106	2578	1



Carraca de 1"

8028650	<i>l</i>		
Ref.	mm	g	ud/caja
8028650	650-26"	4424	5



Adaptadores de 1"

80986	<i>l</i>			
Ref.	Medida	mm	g	ud/caja
80986	1"(H)x3/4"(M)	74	964	2



Carraca de impacto de 1/4" con 12 vasos

K2139			
Ref.	Hexag.	24/21.1/22.2/1.5'	880g

425 04...13	Contenido: 12- Vasos hexagonales de impacto de 1/4" 4; 4.5; 5; 5.5; 6; 7; 8; 9; 10; 11; 12; 13 mm
82421	1-Carraca de impacto de 1/4" de 33Nm



Taladro neumático hasta 6,5mm

82721			
Ref.	mm	g	ud/caja
82721	155mm-6"	700	1

Especificaciones :

Capacidad de portabrocas (mm)....	6.35
R.P.M.....	2600
Presión de trabajo (PSI).....	90
Rosca de entrada de aire.....	1/4"
Consumo de aire l/min.....	57
Reversible.....	No



Taladro neumático hasta 10mm

82731			
Ref.	mm	g	ud/caja
82731	185mm-7.3"	1070	1

Especificaciones :

Capacidad de portabrocas (mm)....	10
R.P.M.....	2500
Presión de trabajo (PSI).....	90
Rosca de entrada de aire.....	1/4"
Consumo de aire l/min.....	230
Reversible.....	Si



Taladro neumático recto hasta 10 mm

82733			
Ref.	mm	g	ud/caja
82733	210mm-8.3"	870	1

Especificaciones :

Capacidad de portabrocas (mm)....	9.5
R.P.M.....	1600
Presión de trabajo (PSI).....	90
Rosca de entrada de aire.....	1/4"
Consumo de aire l/min.....	57
Reversible.....	Si



Taladro neumático acodado hasta 10mm

82734			
Ref.	mm	g	ud/caja
82734	210mm-8.3"	1400	1

Especificaciones :

Capacidad de portabrocas (mm)....	10
R.P.M.....	1500
Presión de trabajo (PSI).....	90
Rosca de entrada de aire.....	1/4"
Consumo de aire l/min.....	57
Reversible.....	Si



Carraca de impacto de 3/8" con 11 vasos

K3133			
Ref.	Hexag.	24/24.7/25.7/1.5'	1030g

435 06...19	Contenido: 11- Vasos hexagonales de 3/8" 6; 7; 8; 10; 11; 12; 13; 14; 15; 17; 19 mm
82432	1- Carraca de impacto de 3/8" de 33Nm
8043075MPB	1- Extensión de impacto de 3/8"x75mm



Vasos hexagonales para ruedas de 1/2"

44585..C					
Ref.	Medida	mm	g	color	ud/caja
4458517C	17	85	225		1
4458519C	19	85	240		1
4458521C	21	85	260		1



Juego de 3 vasos para ruedas de 1/2"

K4032			
Ref.	Hexagonal	24/22.3/23.3/1.5'	930g

Contenido de 1/2":
3-Vasos de impacto de 1/2" para ruedas:
17; 19; 21mm (85mm)



Juego de 7 vasos de impacto punta Torx 1/2"

4078			
Ref.	Torx	20/22.0/23.5/0.82'	1100g

Contenido de 1/2":
7- Vasos de impacto punta Torx:
T30; T40; T45; T50; T55; T60;
T70 (60mm)



Juego de 7 adaptadores de impacto

K4079		
Ref.	12/23.5/24.5/1.4'	1958g

Contenido de 1/2":
7- Adaptadores de impacto
3/8"(H)x1/4"(M); 3/8"(H)x1/2"(M);
1/2"(H)x3/8"(M); 1/2"(H)x3/4"(M);
3/4"(H)x1/2"(M); 3/4"(H)x1"(M);
1"(H)x3/4"(M)



Juego de 10 vasos de impacto punta Torx 1/2"

41013			
Ref.	Torx	20/20.2/21.2/0.82'	1010g

Contenido de 1/2":
10-Vasos de impacto punta Torx:
T20; T25; T27; T30; T40; T45;
T50; T55; T60; T70 (60mm)



Jgo. de 10 vasos de impacto largos de 1/2" (MM)

4107			
Ref.	Hexagonal	10/16.9/27.9/0.7'	2690g

Contenido de 1/2":
10-Vasos de impacto largos de 1/2"
11; 12; 13; 14; 16; 17; 19; 21; 22;
24 mm



Jgo. de 10 vasos de impacto de 1/2" (SAE)

4109S			
Ref.	Hexagonal	20/25.0/26.0/0.6'	1250g

Contenido de 1/2":
10-Vasos de impacto de 1/2"
3/8"; 7/16"; 1/2"; 9/16"; 5/8";
11/16"; 3/4"; 13/16"; 7/8"; 15/16"



Jgo. de 10 vasos de impacto largos de 1/2" (SAE)

4107S			
Ref.	Hexagonal	10/16.9/27.9/0.7'	2690g

Contenido de 1/2":
10-Vasos de impacto largos de 1/2"
3/8"; 7/16"; 1/2"; 9/16"; 5/8";
11/16"; 3/4"; 13/16"; 7/8"; 15/16"



Carraca de impacto Super Duty de 1/2"

82443			
Ref.	mm	g	Ud/Caja
82442	260mm-10.3"	1180	1

Especificaciones:
Cuadradillo..... 1/2"
R.P.M..... 200
Par de trabajo (Ft/Lbs) / (N-M) 5-70 / 7-95
Par Máximo (Ft/Lbs) / (N-M)..... 80 / 108
Presión de trabajo (PSI)..... 90
Entrada de aire..... 1/4"
Consumo de aire l/min..... 93
Baja vibración y sonoridad.



Jgo. de 10 vasos de impacto de 1/2"(MM)

4109			
Ref.	Hexagonal	20/25.0/26.0/0.6'	1250g

Contenido de 1/2":
10-Vasos de impacto de 1/2"
11; 12; 13; 14; 16; 17; 19; 21; 22;
24 mm



Llave de impacto de 1/2" 700Nm

82548	l	g	ud/caja
Ref.	mm	g	ud/caja
82548	210mm-8.3"	2150	1

Especificaciones :

Cuadradillo.....	1/2"
R.P.M.....	6500
Par Máximo (Ft/Lbs) / (Nm).....	525/700
Presión de trabajo (PSI).....	90
Entrada de aire.....	1/4"
Consumo de aire l/min.....	85



Llave de impacto mini composite de 1/2"

82544	l	g	ud/caja
Ref.	mm	g	ud/caja
82544	154mm-6"	1200	1

Especificaciones :

Cuadradillo.....	1/2"
R.P.M.....	12500
Rango de par de trabajo (Ft/Lbs) / (N-M).....	90-260 / 120-351
Par Máximo (Ft/Lbs) / (Nm).....	300 / 400
Presión de trabajo (PSI).....	90..
Entrada de aire.....	1/4"
Consumo de aire l/min.....	115



Llave de impacto mini Super Duty de 1/2"

825411	l	g	ud/caja
Ref.	mm	g	ud/caja
825411	109mm	1300	1

Especificaciones :

Cuadradillo.....	1/2"
R.P.M.....	9000
Rango de par de trabajo (Ft/Lbs) / (N-M).....	102-310 / 138-420
Par Máximo (Ft/Lbs) / (Nm).....	500-677
Presión de trabajo (PSI).....	90
Entrada de aire.....	1/4"
Consumo de aire l/min.....	135



Llave de impacto composite Heavy Duty de 1/2"

82549	l	g	ud/caja
Ref.	mm	g	ud/caja
82549	171mm-6.7"	1950	1

Especificaciones :

Cuadradillo.....	1/2"
R.P.M.....	8000
Rango de par de trabajo (Ft/Lbs) / (N-M).....	50-600 / 68-810
Par Máximo (Ft/Lbs) / (Nm).....	780 / 1054
Presión de trabajo (PSI).....	90
Entrada de aire.....	1/4"
Consumo de aire l/min.....	115



Carraca de impacto de 1/2" con vasos

4118-2	Hexag.	6/15.9/16.9/1.2'	2650g
Ref.	Hexag.	6/15.9/16.9/1.2'	2650g
445 10...17	Contenido:		
82442	7- Vasos de impacto hexagonales de 1/2" 10; 11; 12; 13; 14; 16; 17 mm		
8044075MPB	1-Carraca de impacto de 1/2"		
809QC	1-Extension 75mm		
638M	1-Conector de aire de 1/4"		
	1-Frasco de aceite		



Llave de impacto de 1/2" con vasos

4142-3	Socket	4/20.0/21.0/1.2'	5000g
Ref.	Socket	4/20.0/21.0/1.2'	5000g
445 10...24	Contenido de 1/2":		
82544	10- Vasos de impacto de 1/2" 10; 11; 12; 13; 14; 17; 19; 21; 22; 24 mm		
8044125MPB	1-Llave de impacto mini de 400Nm		
80541MPB	1-Extension de impacto de 1/2" de 125mm		
809QC	1- Articulación universal de impacto de 1/2"		
638M	1-Enchufe rápido (20MP)		
	1-Bote de aceite		



Vaso hexagonal de impacto de 1/2"

445	Medida	mm	g	ud/caja
Ref.	Medida	mm	g	ud/caja
44510	10	38	72	10
44511	11	38	72	10
44512	12	38	74	10
44513	13	38	77	10
44514	14	38	80	10
44515	15	38	82	10
44516	16	38	85	10
44517	17	38	89	10
44518	18	38	89	10
44519	19	38	102	10
44520	20	38	124	10
44521	21	38	124	10
44522	22	40	148	10
44523	23	40	148	10
44524	24	40	154	10
44526	26	45	181	10
44527	27	45	181	10
44530	30	48	218	10
44532	32	48	218	10



Llave de impacto de 1/2" con vasos

4142	Hexagonal	4/20.0/21.0/1.2'	5000g
Part no.	Hexagonal	4/20.0/21.0/1.2'	5000g
445 10...24	Contenido de 1/2":		
82541	10- Vasos de impacto de 1/2" 10; 11; 12; 13; 14; 17; 19; 21; 22; 24 mm		
8044125MPB	1- Llave de impacto de 542Nm		
80541MPB	1- Extension de impacto de 1/2" de 125mm		
809QC	1- Articulación universal de impacto de 1/2"		
638M	1- Enchufe rápido (20MP)		
	1- Bote de aceite		



Vaso hexagonal largo de impacto de 1/2"

44585		<i>l</i>		
Ref.	Medida	mm	g	ud/caja
4458510	10	85	123	10
4458511	11	85	135	10
4458512	12	85	147	10
4458513	13	85	154	10
4458514	14	85	178	10
4458515	15	85	181	10
4458516	16	85	204	10
4458517	17	85	209	10
4458518	18	85	215	10
4458519	19	85	242	10
4458520	20	85	277	10
4458521	21	85	279	10
4458522	22	85	299	10
4458524	24	85	336	10
4458526	26	85	367	10
4458527	27	85	367	10
4458530	30	85	400	10
4458532	32	85	458	10



Vaso hexagonal largo de 1/2" de pared delgada

44585..TH			<i>l</i>		
Ref.	Medida	mm	mm	g	ud/caja
4458517 TH	17	24	85	173	10
4458519 TH	19	26	85	219	10
4458521 TH	21	29	85	240	10
4458524 TH	24	29	85	240	10



Vaso punta Torx de impacto de 1/2"

246060		<i>l</i>		
Ref.	Medida	mm	g	ud/caja
24606020	T20	60	63	10
24606025	T25	60	63	10
24606027	T27	60	63	10
24606030	T30	60	63	10
24606040	T40	60	67	10
24606045	T45	60	71	10
24606050	T50	60	74	10
24606055	T55	60	88	10
24606060	T60	60	99	10
24606070	T70	60	108	10



Vaso punta XZN de impacto de 1/2"

248060		<i>l</i>		
Ref.	Medida	mm	g	ud/caja
24807814	M14	78	110	10
24807816	M16	78	115	10
24807818	M18	78	118	10



Extesiones de impacto de 1/2" con bloqueo

8084..MPB	<i>l</i>		
Ref.	mm	g	ud/caja
8084075MPB	75-3"	170	10
8084125MPB	125-5"	250	10
8084250MPB	250-10"	450	5



Articulación de bola de impacto de 1/2"

80541MPB	<i>l</i>		
Ref.	mm	g	ud/caja
80541MPB	75	139	10



Amplificador de impacto de 1/2" a 3/4"

8094..MPB	<i>l</i>			
Ref.	Medida	mm	g	ud/caja
80946MPB	1/2"(H)x3/4"(M)	48	145	10



Amoladora angular de 125mm

82601	<i>l</i>		
Ref.	mm	g	ud/caja
82601	235mm-9.3"	1800	1

Especificaciones :

Rosca del eje..... M10x1.5
 R.P.M..... 11000
 Presión de trabajo (PSI).....90..
 Entrada de aire..... 1/4"
 Consumo de aire l/min 142



Amoladora recta de 6mm

82602	<i>l</i>		
Ref.	mm	g	ud/caja
82602	145mm-5.7"	600	1

Especificaciones :

Diámetro de pinza..... 3mm; 6mm; 1/8"; 1/4"
 R.P.M..... 22000
 Presión de trabajo (PSI)..... 90
 Entrada de aire..... 1/4"
 Consumo de aire l/min 85



Lijadora roto-orbital de 155mm

82603	<i>l</i>		
Ref.	mm	g	ud/caja
82603	155mm	820	1

Especificaciones :

- Diámetro de lija de 152 mm
- 10000 R.P.M
- Opción de orbitación de 5 mm
- Longitud : 225 mm
- Entrada de aire :1/4".
- Manguera de aire:3/8.
- Consumo de aire: 368 L/min
- Peso: 0.82Kg



Juego de 8 vasos de impacto de 3/4" (MM)

6081			
Ref.	Hexagonal	6/21.0/22.0/0.89'	3500g
465 26...38	Contenido de 3/4": 8-Vasos de impacto 26; 27; 29; 30; 32; 35; 36; 38 mm		



Jgo. de 8 vasos de impacto largos de 3/4"(SAE)

6081DS			
Ref.	Hexagonal	2/13.4/14.4/0.6'	6700g
465100 26...38	Contenido de 3/4": 8-Vasos de impacto largos 1"; 1-1/16"; 1-1/8"; 1-1/4"; 1-5/16"; 1-3/8"; 1-7/16"; 1-1/2"		



Juego de 8 vasos de impacto de 3/4" (SAE)

6081S			
Ref.	Hexagonal	6/21.0/22.0/0.89'	3500g
465 1.0...1.1.2	Contenido de 3/4": 8-Vasos de impacto 1"; 1-1/16"; 1-1/8"; 1-1/4"; 1-5/16"; 1-3/8"; 1-7/16"; 1-1/2"		



Jgo. de 8 vasos de impacto largos 3/4" (MM)

6081D			
Ref.	Hexagonal	2/13.4/14.4/0.6'	6700g
465100 26...38	Contenido de 3/4": 8-Vasos de impacto largos 26; 27; 29; 30; 32; 35; 36; 38 mm		



Llave de impacto de 3/4" con vasos

6111			
Ref.	Hexagonal	2/17.6/18.6/1.4'	8.8kg
465 22...41	Contenido de 3/4": 8-Vasos de impacto 22; 24; 27; 30; 32; 36; 38; 41 mm		
82563	1-Llave de impacto de 1016 Nm		
638M	1-Bote de aceit		



Llave de impacto de 3/4" con vasos

6111-1			
6111-6	Hexag.	2/17.6/18.6/1.4'	8.8kg
465 22...41	Contenido de 3/4": 8-Vasos de impacto 22; 24; 27; 30; 32; 36; 38; 41 mm		
82561	1-Llave de impacto de 1761 Nm		
638M	1-Bote de aceite		



Llave de impacto de 3/4" Heavy Duty

82565			
Ref.	mm	g	ud/caja
82565	280mm-11.0"	5700	1

Especificaciones :

Cuadrado.....	3/4"
R.P.M.....	4000
Par Máximo (Ft/Lbs) / (Nm).....	1350 / 1800
Presión de trabajo (PSI).....	90
Entrada de aire.....	3/8"
Consumo de aire l/min.....	170



Vaso hexagonal de impacto de 3/4"

465				
Ref.	Medida	mm	g	ud/caja
46519	19	50	248	1
46520	20	50	254	1
46521	21	50	254	1
46522	22	50	262	1
46523	23	50	266	1
46524	24	50	268	1
46526	26	50	268	1
46527	27	54	294	1
46528	28	54	364	1
46530	30	54	376	1
46532	32	57	380	1
46533	33	57	412	1
46534	34	57	434	1
46535	35	57	438	1
46536	36	57	432	1
46538	38	57	452	1
46540	40	57	480	1
46541	41	57	498	1
46542	42	57	564	1
46544	44	63	626	1
46545	45	63	658	1
46546	46	63	772	1
46548	48	68	826	1
46550	50	68	880	1



Vaso hexagonal largo de impacto de 3/4"

465100				
Ref.	Medida	mm	g	ud/caja
46510019	19	100	426	1
46510020	20	100	434	1
46510021	21	100	456	1
46510022	22	100	496	1
46510024	24	100	704	1
46510026	26	100	480	1
46510027	27	100	506	1
46510030	30	100	626	1
46510032	32	100	598	1
46510033	33	100	650	1
46510034	34	100	710	1
46510035	35	100	728	1
46510036	36	100	726	1
46510038	38	100	700	1
46510041	41	100	866	1
46510042	42	100	936	1
46510046	46	100	1176	1
46510050	50	100	1312	1

Extensiones de impacto de 3/4"

8046..MPB	<i>l</i>		
Ref.	mm	g	ud/caja
8046100MPB	100-4"	325	2
8046175MPB	175-7"	927	2
8046250MPB	250-10"	1224	2



Juego de 8 vasos de impacto de 1" (MM)

8081			
Ref.	Hexag.	4/24.6/25.6/0.8'	6150g
485 24...41	Contenido de 1": 8-Vasos de impacto de 1" 24; 27; 30; 32; 33; 36; 38; 41 mm		

Juego de 8 vasos de impacto de 1" (SAE)

8081S			
Ref.	Hexag.	4/24.6/25.6/0.8'	6150g
485 15.16...1.5.8	Contenido de 1": 8-Vasos de impacto de 1" 15/16"; 1-1/16"; 1-3/16"; 1-1/4"; 1-5/16"; 1-7/16"; 1-1/2"; 1-5/8"		

Articulación de impacto de bola de 3/4"

80561MPB	<i>l</i>		
Ref.	mm	g	ud/caja
80561MPB	110	624	1



Adaptadores de impacto de 3/4"

8096..MPB	<i>l</i>			
Ref.	Medida	mm	g	ud/caja
80964MPB	3/4"(H)x1/2"(M)	58	320	2
80968MPB	3/4"(H)x1"(M)	63	400	2



Juego de 8 vasos de impacto largos de 1" (MM)

8081D			
Ref.	Hexag.	2/18.4/19.4/0.6'	9200g
485100 24...41	Contenido de 1": 8-Vasos de impacto largos de 1" 24; 27; 30; 32; 33; 36; 38; 41 mm		

Juego de 8 vasos de impacto largos de 1" (SAE)

8081DS			
Ref.	Hexag.	2/18.4/19.4/0.6'	9200g
485100 15.16...1.5.8	Contenido de 1": 8-Vasos de impacto largos de 1" 15/16"; 1-1/16"; 1-3/16"; 1-1/4"; 1-5/16"; 1-7/16"; 1-1/2"; 1-5/8"		

Adaptador de impacto de 1"

8098..MPB	<i>l</i>			
Ref.	Medida	mm	g	ud/caja
80986MPB	1"(H)x3/4"(M)	75	596	2



Llave de impacto de 1" con vasos

8091			
Ref.	Hexag.	1/20.8/21.8/2.5'	20.8kg
485 27...41	Contenido de 1": 8-Vasos de impacto de 1" 27; 30; 32; 33; 35; 36; 38; 41 mm		
82585	1-Llave de impacto larga de 2439Nm		
638M	1-Bote de aceite		

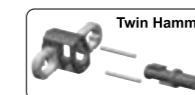

Llave de impacto de 1-1/2"

825121	<i>l</i>		
Ref.	mm	kg	ud/caja
825121	452mm-17.8"	15.8	1

Especificaciones :

- Cuadrado..... 1-1/2"
- R.P.M..... 3000
- Par Máximo (Ft/Lbs) / (Nm)..... 2500 / 3388
- Presión de trabajo (PSI)..... 90
- Entrada de aire..... 1/2"
- Consumo de aire l/min..... 411

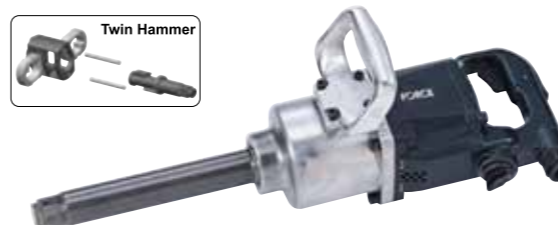
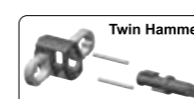

Llave de impacto de 1" larga con vasos

82585	<i>l</i>		
Ref.	mm	kg	ud/caja
82585	518mm-20"	12.5	1

Especificaciones :

- Cuadrado..... 1"
- R.P.M..... 4000
- Par Máximo (Ft/Lbs) / (Nm)..... 1800 / 2439
- Presión de trabajo (PSI)..... 90
- Entrada de aire..... 1/2"
- Consumo de aire l/min..... 340

FORCE

PARTE J

HERRAMIENTAS PARA EL MOTOR

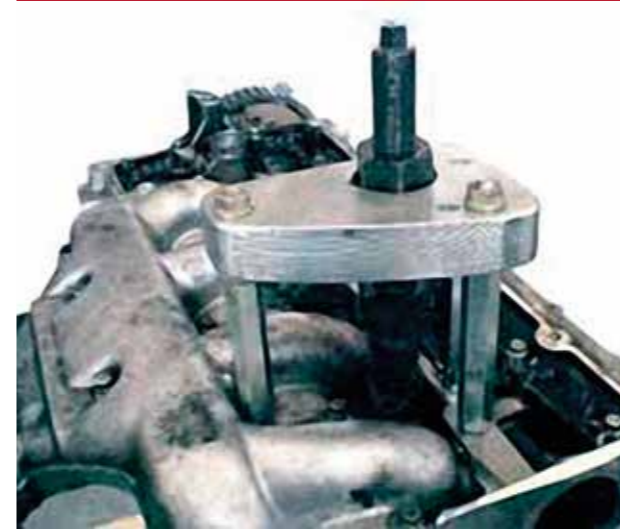

■ **Juego de 2 adaptadores con torque para bujías**

K3021



Contenido: 3/8"

832 318...324 2 Adaptadores con torque: 18Nm y 24Nm

24/12.0/13.0/0.8' 500g

■ **Llave articulada magnética para bujías**

8074...UM



Ref.	Medida	l mm	g	pzs./caja
807430016UM	16mm	300	356	30
807430020.6UM	20.6mm	300	394	30
807450016UM	16mm	500	554	20
807450020.6UM	20.6mm	500	592	20

■ **Vaso magnético de 1/2" para bujías**

8074...M



Ref.	Medida	l mm	g	pzs./caja
807414M	14mm	70	72	10
807416M	16mm	70	86	10
807420.6M	20.6mm	70	148	10

■ **Juego de extractores de bobina de encendido VW, AUDI**

904T5



Útil de apertura de 18mm: Motores de 6 cilindros 24v y 5 cilindros, Volkswagen Golf, Bora (desde 1998), Passat/Touareg (desde 1997), Sharan (desde 1996), Phaeton, Touareg 6 cilindros (desde 2003), Transporter T5 inyección de combustible de 6 cilindros (desde 2004).

Útil de apertura de 26mm: Motores VW FSI: Golf/Bora (desde 1998), Polo (desde 2002), Touran (desde 2004), New Beetle (desde 2003), Passat (desde 1997), T4+A2 (desde 2001), Caddy 1.4, Bora 1.4 y 1.6, Lupo, Phaeton, Transporter T4.

Útil de apertura de 44mm: Motores Volkswagen inyección 2.0, Golf/Touran (desde 2004), Passat/Eos (desde 2006), Audi inyección A3 (desde 2004) 2.0 I, A6 (desde 2005) 3.2 I



10/9.5/10.5/1.1' 950g

■ **Comprobador de chispa de bujía**

9G3101 / 9G3102



- **9G3101** para sistema HEI
- **9G3102** para bujías estándar



100/6/7/2' 60g

■ **Juego para puesta a punto diésel y gasolina de 13 Pzs.**

913G3



- Para usar en motores diésel y gasolina de turismos y furgonetas Audi, Citroen, Peugeot, Volkswagen y Volvo.
- Tras utilizar hay que quitar del motor y recoger todas las piezas del juego. Girar el motor 2 veces para completar un ciclo. Una vez hecho esto volver a bloquear en la posición central y comprobar la correcta alineación. Volver a recoger las piezas y comprobar otro ciclo completo.

20/22.1/23.5/1.4' 1.1Kg

■ **Kit de bloqueo de árbol de levas de 8 Pzs.**

908G4



Incluye los útiles para bloquear el árbol de levas de los motores multiválvula a la hora de sustituir la correa de distribución.

Aplicable a:

- Arbol de levas de Opel Calibra, Omega, Sintra, Vectra 1.4 / 1.6 y 1.8 / 2.0
- Arbol de levas derecho Saab 900 2.5 / 3.0 y Opel Calibra, Sintra, Vectra 2.5 / 3.0
- Arbol de levas izquierdo Saab 900 2.5 / 3.0 y Opel Calibra, Sintra, Vectra 2.5 / 3.0
- Bloqueo de árbol de levas para motores TDI de VW, Audi, Skoda, Seat y Ford
- Retenedor del volante Citroen, Fiat y Peugeot y para Isuzu 1.5 / 1.7 Diesel, Opel 1.6 / 1.7 Diesel y Opel 1.2 / 1.4 / 1.6 / 1.8 / 2.0 OHC.

10/10.1/11.1/1.1' 1Kg

Kit de bloqueo de árbol de levas de 16 Pzs.

916G1



• El kit incluye los útiles para bloquear el árbol de levas de los motores multiválvula a la hora de sustituir la correa de distribución.

Aplicable a:

• Vauxhall, Opel, SAAB, Rover, Volkswagen, Citroen, Fiat, Ford, Peugeot, Isuzu etc...

5/13.4/14.4/1.4' 2.7Kg

Kit de bloqueo de árbol de levas de 19 Pzs. universal

919G1



Contenido:

- 10 Útiles de bloqueo del árbol de levas
- 4 Pasadores de bloqueo
- 1 Placa de bloqueo
- 1-Pasador para el compensador
- 2 Pasadores de bloqueo en el PMS y de sujeción del volante.

Aplicable a:

- **Citroen:** Synergie 2.0/Turbo; ZX 1.9D/TD; Xantia 1.9D/TD y Berlingo 1.9D
- **Fiat:** Ulysse 2.0/Turbo; Ducato 2.0
- **Ford:** Fiesta 1.25/1.4/ 12.8-XR2i/1.8-16V desde 1995; Mondeo 1.6/1.8/2.0-16V desde 1993; Escord/Orion 1.6/1.8-16V desde 1992
- **Honda:** Accord/Prelude 1.8/2.0/2.0i/2.2/2.2i 2.3i desde 1993; Accord/Prelude 2.0-16V desde 1990; Prelude 2.2 V-Tec SOHC; Shuttle 2.2i; Civic 1.6 Vti
- **Mazda:** 121/1.25
- **Opel:** Calibra, Vectra, Omega, Sintra 2.5L y 3.0L; Ecotec 1.4/1.6/1.8/2.0L; Astra 2.0-16V, Calibra 2.0-16V hasta 1992; Motores 1.2/1.4/1.6/1.8/2.0 OHC y 1.6D/1.7 OHC 1.5/1.7 OHC Diesel (Isuzu)
- **Peugot:** 205 1.6/1.9; 305 1.6/1.9; 309 1.6/1.9; 405 1.6/1.8/1.9/2.0; 605 2.0 Boxer 2.0; 205-305-306-309-405 1.8D/1.9D y TD 605 D/TD; 806 1.9TD; Expert 1.9D; Boxer 1.9D/TD
- **Renault:** 1.2/1.4/1.6/1.9/2.1 R5, R9, Clio, Express, Espace, Megane, Senic Diésel; Clio 1.7/1.8 Gasolina; Megane-Senic 2.0 Gasolina; Laguna 1.8/2.0 Códigos de motor F3N / F3P / F2R Gasolina; Clio Williams, Megane 2.0-16V Twin Cam, Códigos de motor F7P / F7R Gasolina; Laguna/Safrane 2.0-16V Twin Cam, Códigos de motor N7Q / N7U Gasolina;
- **Rover:** 618/620/623 SOHC desde 1993; 216/416 Gti 16V hasta 1995 D16A9; 220/320/420/820 Turbo Motor T16/M16; K16 DOHC
- **Land Rover:** Discovery MPi 2.0-16V 20T4
- **Saab:** 900 2.5L y 9000 3.0L V6
- **Volkswagen:** Bora, Golf, Lupo, Polo Tdi's

10/15.0/16.0/1.6' 1.5Kg

Kit de bloqueo del árbol de árbol de levas

9G2401



• Bloquea el árbol de levas en motores multiválvula mientras se cambia la correa de distribución. Se encaja en los piñones. Diésel y gasolina



• Se ajusta a diversos tamaños de diente. También sirve para bloquear los engranajes entre el árbol de levas y la bomba de inyección de diésel.

• Se necesita un solo operario

32/11.8/12.8/4.2' 370g

Juego para puesta a punto de OPEL diesel 1.9 CDTI

905G16



Diseñado para cambios de correa de distribución en coches Vauxhall/ Opel y Saab con motores 1.9CDTi/TiDEL kit contiene los tornillos para alinear el árbol de levas, la polea del cigüeñal y el pasador para el tensor.

Motores:

• 1.9 CDTI/TID

Modelos:

• Opel Astra H, Vectra C, Signum, Zafira B

• Saab 9-3, 9-5

Códigos de motor:

• Z19DT, Z19DTH, Z19DTL



20/13.4/14.0/0.9' 670g

Juego para puesta a punto de Opel /Vauxhall

920G2



• Sirve para otras marcas con los motores Opel : Saab, Renault, etc.

Modelos:

Agila, Astra, Corsa, Frontera, Meriva, Omega, Signum, Sintra, Speedster, Tigra, Vectra y Zafira.

Gasolina:

• 1.0 12V / 1.2 16V desde 1997 (Eco Tec) Códigos de motor: X10XE / X12XE / Z10XE / Z12XE / Z10XEP / Z12XEP / Z14XEP

• 1.4 / 1.6 / 1.8 / 2.0 / 2.2 16V desde 1995 (DOHC) Códigos de motor: X14XE / X16XEL / X16SEJ / X18E1 / X18XE1 / Y16XE / Z14XE / Z16XE / Z18XE / Z18XEL / X18XE / C20SEL / X20XEV / Z20LET / X22XE / Y22XE / Z22XE

Diesel:

• 1.3CDTi 16V / 1.9CDTi / 2.0DTi / 2.2DTi Códigos de motor: Z13DT / X20DTL / X20DTH / Y20DTL / Y20DTH / X22DTH / Y22DTH / Y22DTR / Z19DT / Z19DTH

5/19.0/21.5/1.7' 3800g

■ Juego para puesta a punto para GM/Opel 1.3 CDTI diésel

904G5



Para motor diésel de cadena 1.3 D-DDIS-JTD-CDTI

El kit incluye pasador de bloqueo del volante, útiles de alineación del árbol de levas y pasador de tensado.

- Alfa Romeo MiTo (08-12)
- Fiat 500 (07-12), Doblo/Cargo (04-10), Fiorino (08-11), Grande Punto (05-11) Idea (04-11), Linea (07-11), Panda (03-11), Punto (03-11), Punto EVO (09-12), Qubo (08-11)
- Ford Ka (09-12)
- Lancia Musa (04-11), Ypsilon (03-11)
- Suzuki Ignis (03-09), Splash (08-11), Swift (06-10), Wagon R+ (03-08)
- Opel Agila (03-12), Agila B (08-10), Astra H (04-11), Astra J (09-12), Combo C (03-12), Corsa C (03-07), Corsa D (06-12), Meriva A (04-10), Meriva B (10-11), Tigra B (04-10)

Códigos de motor:

- Z13DT, Z13DTH, Z13DTJ

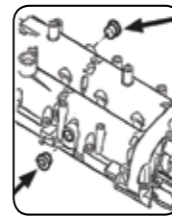

48/22.0/23.0/2.7' 280g

■ Juego de puesta a punto para diesel Opel / Renault / Nissan

911G5



Para motores DCI /CDTI 1.5/1.9/2.2/2.5 en Opel, Renault, Dacia, Nissan, Mitsubishi y Suzuki

Modelos:

Renault: Clio II/Clio Campus/Clio Storia (01-11), Clio III (05-11), Espace/Grand Espace (00-02), Espace/Grand Espace IV (02-09), Fluence (09-12), Kangoo (00-09), Kangoo Trekka (01-05), Kangoo II/Kangoo Be-Bop (08-12), Laguna (99-01), Laguna II (01-07), Laguna III (07-12), Logan/Logan MCV (05-11), Master II (01-10), Megane (99-03), Megane II (02-10), Megane III (08-12), Modus (04-08), Modus/Grand Modus II (08-11), Scenic /RX4 (99-03), Scenic/Grand Scenic II (03-09), Scenic/Grand Scenic III (09-11), Trafic II (01-12), Twingo II (07-10), Vel Satis (02-09)

Nissan: Cube Z12 (08-11), Interstar X70 (02-11), Juke F15 (10-12), Kubistar X76 (03-09), Micra K12 (03-10), Note E11 (06-12), NV200 M20 (09-12), Primastar X83 (02-12), Primera P12 (03-07), Qashqai/ +2 J10 (07-10), Tiida C11 (07-11)

Opel: Movano-A (00-10), Vivaro (01-12)

Suzuki: Grand Vitara (05-12), Jimny (03-11)

Dacia: Duster (10-12), Logan/MCV/Express/Pick Up (05-11)

Mitsubishi: Carisma (01-05)

Códigos motor:

1.5D dCi K9K: 700, 702, 704, 706, 710, 712, 714, 716, 718, 722, 724, 728, 729, 732, 740, 750, 752, 760, 762, 764, 766, 768, 772, 780, 782, 790, 792, 794, 796, 800, 802, 804, 806, 808, 830, 832, 834, 836, 837, 884, 892, 894, 896, 898

1.5D DDiS K9K: 262, 266, 299

1.9D DDiS: F9Q B2

1.9D Di-D: F9Q 1, F9Q 2

1.9D dCi F9Q: 650, 660, 664, 670, 674, 680, 690, 718, 732, 733, 740, 748, 750, 751, 752, 754, 758, 759, 760, 762, 772, 774, 775, 790, 800, 803, 804, 808, 812, 814, 818, 820, 826, 870, 872

2.2D dCi G9T: 600, 605, 606, 607, 642, 700, 702, 703, 706, 707, 710, 720, 722, 742, 743, 750, 772

2.5D dCi G9U: 630, 632, 650, 720, 724, 726, 730, 750, 754

10/20.4/21.0/1.4' 2040g

■ Juego de puesta a punto para RENAULT, NISSAN, OPEL 2.0 dCi

908G12



• Este juego incluye útiles para bloquear la distribución de cadena de los motores diesel dCi.

• La cadena solamente necesita revision o cambio cuando los engranajes o los tensores se desmontan.

• Aplicable a: RENAULT 2.0 dCi M9R OPEL 2.0 CDTi M9R

NISSAN 2.0 dCi

Modelos:

Nissan:

Primastar (08-09), Qashqai (08-09), X-Trail (07-08)

Motores M9R 780, 830, 832, 833

Renault:

Koleos(08-09), Laguna (05-08), Megane (07-08)

Scenic (08-09), Trafic(07-08), Velsatis(08-09)

Motores M9R700, 721, 724, 740, 742, 446, 760

761, 780, 802, 803, 805, 830, 832, 833

Opel:

Vivaro(07-08) Motores M9R 780,782,784



10/22.0/23.0/1.6' 2200g

■ Kit de bloqueo de árbol de levas Renault

902G5

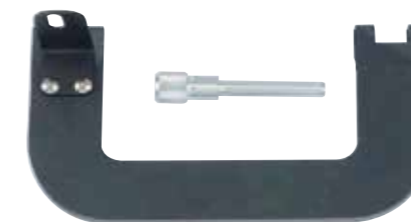

Para RENAULT LAGUNA 2.0 IDE (2001-2005) Motor F5R .



30/16.0/17.0/1.6' 530g

■ Juego de puesta a punto para Renault

917G1



Gasolina:

- Twingo / Clio / Kangoo 1.2 (desde 1995) Códigos de motor: D7F 700, 701, 710, 730
- R5 / Clio I / R11 / R19 / R21 / Trafic 1.7 (1986-1996) Códigos de motor: F1N, F2N, F3N, F2R
- Clio I 1.2/1.4 (desde 1988) Códigos de motor: E5F, E6J, E7F, E7J
- R19 1.4 / R19 ECO / Extra / Express / Rapid / Kangoo 1.4 (desde 1988) Códigos de motor: E5F, E6J, E7F, E7J
- Clio II / Megane / Scenic / Laguna 1.4/1.6 16V (desde 1988) Códigos de motor: K4J 712, 713, 750 / K4M 700, 701, 720, 724, 748
- Clio and R19 1.8 16V / Clio Williams 2.0 16V (1989-1997) Códigos de motor: F7P 700/4 / F7P 720/2 / F7R 700
- Clio I / R19 / Laguna 1.8 / Espace 2.0 (1992-2001) Códigos de motor: F3P, F3R
- Laguna 1.8 16V / Clio Sport / Megane / Scenic / Laguna / Espace 2.0 16V (desde 1998) Códigos de motor: F4P 760 / F4R 700, 701, 730, 740, 741, 744, 780
- Laguna 1.8 16V (2001-2005) Códigos de motor: F4P 770, 771
- Laguna 1.8 16V (2001-2005) Códigos de motor: F5R
- R18 / Fuego / R25 / Espace / Trafic / Master 2.0 8V and R20 / R21 / R25 2.0 12V / Espace 2.2 8V (1980-1998) Códigos de motor: 829 / J5R / J6R / J7R 720, 721, 722, 723, 726, 740, 750, 751, 754, 755 / J7T 600, 772, 782
- Megane / Scenic 1.4/1.6 (1996-1999) Códigos de motor: E7J 764 / K7M 702, 703, 720
- Megane / Scenic 2.0 (1996-1999) Códigos de motor: F3R 750, 751
- Megane 2.0 16V (1996-1999) Códigos de motor: F7R 710
- R21 Turbo / Espace 2.0 (1986-1993) Códigos de motor: J7R 760 / J7R 752
- Laguna/Safrane 2.0 16V Safrane 2.5 20V (1996-2001) Códigos de motor: N7Q 700, 704, 710, 711 / N7U 700, 701
- Safrane 2.0 (1992-1997) Códigos de motor: J7R 732, 733, 734, 735, 752, 756
- Safrane 2.2 12V (1992-1997) Códigos de motor: J7T 760, 761, 762

Diésel:

- Clio III, Kangoo 1.5 DCi (2001-2005) Códigos de motor: K9K 702, 704, 710
- R5 / R9 / R11 1.6 D R5 / R5 Van / Clio / Clio Van / (Express/Extra/Rapid) / (R19/Turbo/Chamade) / R21 1.9 (desde 1989) Códigos de motor: F8M (type 4) / F8Q
- Megane/Scenic 1.9 TD / Laguna 1.9 TD/DTi / Espace 1.9 DTi (1997-2002) Códigos de motor: F9Q 710, 716, 720, 722, 730, 734, 736
- Megane 1.9 DCi / Scenic 1.9 DCi (1999-2005) Códigos de motor: F9Q 732
- Clio / Megane / Laguna / Kangoo 1.9 DTi (desde 1999) Códigos de motor: F9Q 717, 731, 780
- Clio / R19 / Express / Extra / Rapid / Kangoo 1.9 D / (Megane/Scenic) / R19 1.9 TD (1990-2002) Códigos de motor: F8Q
- Fuego / R18 / R20 / R21 / R25 / R30 / Espace D Turbo and Trafic/Master 2.1 D (1979-2000) Códigos de motor: J8S
- Laguna 1.9 DCi / Trafic 1.9 DCi (1999-2005) Códigos de motor: F9Q 718 / F9Q 760
- Laguna II 1.9 DCi (2001-2005) Códigos de motor: F9Q 750 / F9Q 754
- Megane 1.9 D / Megane/Scenic 1.9 TD (1995-1999) Códigos de motor: F8Q620 / F8Q784
- Megane / Scenic 1.9 TD / Laguna 1.9 TD/DTi / Espace 1.9 DTi (1997-2001) Códigos de motor: F9Q 710, 716, 730, 734, 736
- Megane / Scenic / Laguna 1.9 TD (desde 1999) Códigos de motor: F9Q 732 / F9Q 718
- Espace 1.9 DCi (2002-2005) Códigos de motor: F9Q 820
- Laguna 2.2 D (1994-1996) Códigos de motor: G8T 706, 790
- Laguna 2.2 D / Laguna/Safrane/Espace 2.2 TD (1995-2000) Códigos de motor: G8T 714, 716, 740, 752, 760, 792, 794
- Trafic/Master 2.5 D / Master 2.5 TD (1980-2000) Códigos de motor: S8U 720, 722, 730, 731, 742, 748, 750, 752, 758, 780, 782 / S9U 700, 702, 704, 714, 740
- Master 2.5 D / Master 2.8 D Turbo (desde 1998) Códigos de motor: S8U 770, 772 / S9W 700, 702

También sirve para Opel Arena/Movano y Volvo V40/S40

5/26.1/27.1/3.5'

5.2Kg

■ Kit de bloqueo para Renault (Motores DCI)

903G5



- LAGUNA, KANGOO y CLIO-DIESEL
- Bloqueo del cigüeñal PIN-MOT 1489 1.5 DCI
- Bloqueo del cigüeñal PIN-MOT 1430 1.5 DCI
- Bloqueo del cigüeñal PIN-MOT 1054 1.9 DCI

10/24.5/25.5/1.4'

245g

■ Kit de bloqueo de correa de distribución RENAULT 1.8 / 2.0 16V

907G15



Diseñado para bloquear el engranaje del árbol de levas En motores de gasolina Renault 1.8/2.0 16v. Necesario para sacar los tornillos del engranaje del árbol de levas al reemplazar la correa.

Modelos:

- Clio II (2006-2009)
- Megane (1999-2003)
- Megane II (2002-2009)
- Scenic/RX4 (1999-2003)
- Scenic/Grand Scenic II (2003-2009)
- Laguna (1998-2001)
- Laguna II (2001-2009)
- Espace/Grand Espace (1998-2002)
- Espace/Grand Espace IV (2002-2009)
- Traffic II (2001-2009)

Códigos de motor:

- 1.8 / 16V: F4P, 720, 721, 722, 770, 773, 774, 775
- 2.0 / 16V: F4R, 700, 701, 712, 713, 714, 715, 720, 730, 732, 736, 738, 740, 741, 744, 746, 747, 760, 761, 762, 763, 764, 765, 766, 767, 770, 771, 774, 776, 784, 786, 787, 790, 792, 794, 795, 797, 830

15/15.0/16.0/0.86'

1000g

■ Kit de bloqueo de poleas para FORD

905G8



Motores:

- 1.6 Ti-VCT, 2.0 TDCi

Aplicable a:

- Ford Focus, C-Max

Códigos de motor:

- HXDA (2003-2007), G6DA, G6DB, G6DC(2003-2007)

También incluye los pasadores para bloquear el volante.

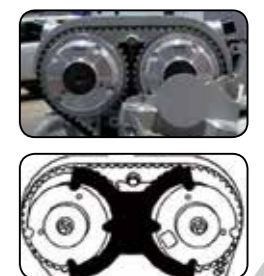

10/8.4/9.4/0.8'

830g

■ Juego de puesta a punto para Ford y Mazda

922G2



Aplicable a: Ford Puma, Fiesta, Endura, Mazda
 Motores:
 • 1.25, 1.4, 1.6, 1.7, 1.8, 2.0 DOHC Zetec petrol, 1.8D / TD, 1.8 Di diesel
 • HPi gasolina, HDi diésel
 • Kit para cambiar la correa de distribución con los útiles de bloqueo del árbol de levas, volante y cigüeñal.



5/16.5/17.5/2' 3.3Kg

■ Juego de puesta a punto para FORD

911G6

NEW



• Este juego incluye os útiles de bloqueo y de extracción de la bomba de inyección para motores diésel Ford 2.0 y 2.4 Duratorq.
 • Aplicable a: Ford Mondeo 2.0 / 2.2 TDDi / TDCi(01 -07) ; Ford Transit 2.0 / 2.2 / 2.4 TDDi / TDCi (00 - 08) ; Jaguar X-Type 2.0 / 2.2 D (03 - 08); LDV Convoy 2.4 TD / Tdi (02 - 06)
 • Códigos de motor: ABFA, D5BA, D6BA, F3FA, F1FA, FMBA, FMBB, D2FA, D3FA, D4FA, D0FA, F4FA, FXFA, H9FA, HJBA, HJBB, HJBC, HJBE, N7BA, N7BB, QJBA, QJBB, QJBC, SDBA



10/16.0/17.0/1.2' 1864g

■ Juego de puesta a punto para FORD

904G6

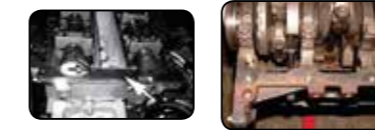

Contenido:

- 3 Pines de bloqueo del cigüeñal
- Placa de alineación

Modelos:

- **Ford:** Fiesta (1995-2008); Fusion (2002-2008); Puma (1997-2002); Focus (1998-2008); Focus C-Max (2003-2008); Mondeo (1993-2008); Cougar (1998-2001); S-Max (2006-2008); Galaxy (2006-2008); Courier (1995-2008); Tourneo Connect (2002-2006); Transit Connect (2002-2006)
- **Mazda:** 121 (1995-2000); 2 (2002-2007); 3 (2003-2006); 6 (2002-2007); Tribute (2001-2004)
- **Volvo:** S40/V50 (2004-2008)

Códigos de motor:

Ford: 1.25 16V (Correa): DHA, DHB DHC, DHE, DHD DHF, DHG F8JA, F8JB FUJA, FUJB M7JA, M7JB; 1.4 16V (Correa): ASDA, ASDB, FHA, FHD FHE, FHF FXDA/C FXDB/D FXJA, FXJB; 1.6 16V (Correa): FYDA/C, FYDB/D FYJA, FYJB, L1F L1J, L1L, L1N L1Q, L1T, L1V L1W, HWDAAHWDB; 1.7 16V (Correa): MHA, MHB; 1.8 16V (Correa): EYDB, EYDC EYDD, EYDE EYDF, EYDG EYDI, EYDJ EYPA, EYPC RKA, RKB RKF, RKH,RKJ, RKK; 1.8 16V (Cadena): CDBB, CGBA/B,CHBA/B, CSDA,CSDB, QQDA, QQDB, QQDC; 2.0 16V (Correa): EDDBA/C, EDDB EDBD, EDDB EDDC, EDDD EDDF, NGA, NGB, NGC NGD; 2.0 RS/ST170 (Correa): ALDA, HMDA; 2.0 16V (Cadena): AODA, AODB,AOWA, CJBA/B; 2.3 16V: SEBA, SEWA, GZFA, GZFB
Mazda: 1.25 16V: DHA, FUJA, FUJB; 1.4 16V: FXJA, FXJB; 1.6 16V:FYJA; 1.8 16V: L8; 2.0 16V: LF, YF; 2.3 16V: L3
Volvo: B4164S3

48/14.0/15.0/0.8' 270g

■ Juego de puesta a punto para FORD

916G5

NEW



• Kit válido para bloquear distribuciones de una gran variedad de motores Ford tanto diésel como gasolina.
 • También es aplicable a los motores Ford montados en Land Rover, Mazda, PSA, Suzuki y Volvo.
 • El juego incluye los útiles para bloquear el árbol de levas, cigüeñal/volante y tensor así como para el desmontaje de la patea dentada del árbol de levas.
 • Aplicable a: **Gasolina:** Fiesta 1.25/1.4/1.6 (95-08), focus 1.4/1.6/1.8/2.0 (98-08) 1.6 VCT-Ti (04-09), C-Max 1.8/2.0 (02-08) 1.6. VCT-Ti (04-09), Fusion 1.25/1.4/1.6 (02-08), Mondeo 1.8/2.0 (98-08), Puma 1.7 (97-02), Tourneo Connect 1.8 (02-06), Transit Connect 1.8 (02-06)
Diésel: Courier 1.4/1.6/1.8 (00-02), Fiesta 1.4/1.6/1.8 (02-09), focus 1.6/1.8/2.0 (98-00), C-Max 1.6/2.0 (03-08), fusion 1.4 (02-08), galaxy 2.0 (06-08), Mondeo 2.0 (07-08), S-Max 2.0 (06-08), Tourneo Connect 1.8 (02-08), Transit Connect 1.8 (02-08)

5/12.3/13.5/1.28 2460g

■ Juego de bloqueo de árbol de levas (Ford / Mazda)

9G1211



Placa de bloqueo del árbol de levas
 También sirve para motore ZETEC de FOCUS, MONDEO y COUGAR de 1998 en adelante. Así mismo también sirve para motores FORD 1.6, 1.8 16V de gasolina.
 Pasador de PMS del cigüeñal FORD 1.25 y 1.4 y motor del Puma 1.7.
 Pasador de PMS compatible con motores MAZDA 121 1.25LTR de gaolina.

100/25.8/26.8/1.7' 260g



Kit de tensado de cadena de distribución para Ford

9G1701



Para sacar el tensor de la cadena de distribución y ajustar la tensión de dicha cadena en motores Ford de 6 cilindros.

72/20.0/21.0/1.9' 280g

Juego de puesta a punto para BMW (M52, M54, M56)

905G1



Modelos:

M52TUB25: E46 323i/323Ci/323ti (M52T) (1997-2001); E39 523i (M52TU) (1998-2001); E36/7 Z3 (M52TU) (1998-2001)

M52TUB28: E46 328i/328Ci (M52TU) (1997-2001); E36/7 Z3 2.8 (M52B28/Z3) (1997-2001); E39 528i (M52TU) (1998-2001); E38 728i (M52TU) (1998-2001)

M54B22: E46 320i/320Ci (2001-2003); E39 520i (2001-2003); E36 Z3 2.2i (2001-2002); E85 Z4 2.2i (2003-2005); E60/E61 520i (2003-2005)

M54B25: E36/7 Z3 2.5i (2001-2002); E46 325i/325xi (2001-2005); E46 325Ci (2001-2006); E46 325ti (2001-2004); E39 525i (2001-2004); E60/E61 525i/525xi (2003-2004); E83 X3 2.5i (2004-2006); E85 Z4 2.5i (2004-2006)

M54B30: E46 330i/330xi (2001-2005); E46 330Ci (2001-2006); E39 530i (2001-2003); E36 Z3 3.0i (2001-2002); E60 530i (2003-2005); E85 Z4 3.0i (2003-2006); E53 X5 3.0i (2001-2006)



5/10.9/11.9/1.35' 2.18kg

Juego de puesta a punto para (BMW MINI)

907G6



Aplicable a: BMW MINI 2001~2006, MINI COOPER S 2002~2006 y MINI COOPER 2001~2006.

Contenido:

- 1 Útil de bloqueo de la polea del árbol de levas.
- 1 Soporte para el motor
- 1 Útil de ensamblaje del tensor

5/9.9/10.9/1' 2kg



Juego de puesta a punto para BMW

908G3



- Para motores BMW M42 y M50: Incluye 2 placas de bloqueo articuladas y un pasador de bloqueo para alinear el árbol de levas.
- Para motores BMW M40 y M70: Incluye placa y un pasador de bloqueo para alinear el árbol de levas.
- Para motores BMW M60 y M62: Incluye 2 placas de bloqueo articuladas y un pasador de bloqueo para alinear el árbol de levas.

2/14.7/16.0/1.25' 7.35kg

Juego de puesta a punto para BMW M41, M51, M47, M57

913G6



Aplicable a motores diésel BMW, Rover y Vauxhally.

Modelos:

• **BMW:** E36 318tds / 318tds Compact (1994-2000) y 325td / 325tds (1991-1999); E34/E39: 525td / 525tds (1991-2003); E38: 725tds (1991-2003); E87: 118d / 120d; E46: 318d / 318td Compact y 320td Compact / 320d / 330d; E39: 520d / 525d / 530d; E60/E61: 525d / 530d / 535d; E63: 635d; E38/E65/E66: 730d; E83: X3 2.0 diesel / X3 3.0 diesel; E53/E70: X5 3.0 diesel; E90/E91: 316i / 316ti / 318ci / 318ti / 320i; E90/E91/E92/E93: 318i / 320i

• **Range Rover:** 2.5 DT (1994 - 2002); 3.0 TD6 (2002 - 2006)

• **Freelander:** 2.0 TD4 (2002 - 2006)

• **Rover:** 75 / MG / MG ZT

• **Opel:** Omega B

Códigos de motor:

• M41

• M51

• M47 TU / M47 TU T2

• M57 TU / T2 2.0l / 3.0l (1998-2008)

• 204D3 / Td4 y Td6

• M47R

5/19.0/20.0/1.4' 3800g

Útil para poleas de BMW

9G1207



- Para BMW M50 M52 S50 S52 M42 M44
- Para girar las poleas al reparar la distribución.



60/16.8/17.8/2.5' 280g



■ Juego de puesta a punto para BMW M47

905G17

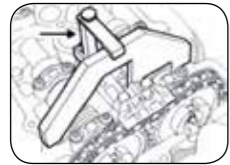

Aplicable a motores de 4 y 6 cilindros 2.0D 16V, 1.8, 2.0, 2.5, 3.0D.

Contenido:

- Útil de bloqueo del árbol de levas para BMW: motores de 4 y 6 cilindros 2.0D 16V, 1.8, 2.0, 2.5, 3.0D.
- Útil de bloqueo del cigüeñal para BMW: motores de 4 y 6 cilindros 2.0D 16V, 1.8, 2.0, 2.5, 3.0D.
- Retenedor del útil de bloqueo del árbol de levas para BMW: motores de 4 y 6 cilindros 2.0D 16V, 1.8, 2.0, 2.5, 3.0D.
- Tensor de la correa de distribución de 4mm para BMW: motores de 4 y 6 cilindros 2.0D 16V, 1.8, 2.0, 2.5, 3.0D.

Modelos:

- BMV 318d LCI (E46), 320d (E46), 320Cd LCI (E46), 320d LCI (E46), 320td (E46), 325d (E90), 325d M LCI (E90), 325d A LCI (E90), 325d (E91), 325d M LCI (E91), 325d A LCI (E91), 330d (E46), 330d LCI (E46), 330xd (E46), 330xd LCI (E46), 330d (E90), 330xd (E90), 330d (E91), 330xd (E91), 330d (E92), 330xd (E92), 330d (E93), 330d M LCI (E90), 330d A LCI (E90), 330d M LCI (E91), 330d A LCI (E91), 335d (E90), 335d A LCI (E90), 335d (E91), 335d A LCI (E91), 335d (E92), 335d A (E92), 520d LCI (E39), 525d LCI (E39), 525d M LCI (E60), 525xd M LCI (E60), 525xd M LCI (E61), 525d M (F10), 525d A (F10), 525d xDrive M (F10), 525d xDrive A (F10), 530d (E39), 530d LCI (E39), 530d (E60), 530xd (E60), 530d (E61), 530d M LCI (E60), 530xd M LCI (E60), 530d M LCI (E61), 530xd M LCI (E61), 530d M (F10), 530d A (F10), 530d xDrive M (F10), 530d xDrive A (F10), 535d M LCI (E60), 535d A (F10), 635d A LCI (E63), 635d A LCI (E64), 730d A LCI (E38), 730d LCI (E38), 730d A LCI (E65), 730Ld A LCI (E66), 730d A (F01), 730Ld A (F02), X3 2.0d (E83), X3 2.0d M LCI (E83), X3 3.0d M (E83), X3 3.0d A (E83), X3 3.0d M LCI (E83), X3 3.0d A LCI (E83), X3 3.0sd A LCI (E83). X5 3.0d (E53), X5 3.0d A (E70), X5 3.0sd A (E70), X6 xDrive 3.0d (E71), X6 xDrive 3.5d (E71)

- Rover 75
- Land Rover Freelander

Códigos de motor:

- BMW M47 D20, M47 D20 02, M57 D25, M57 D29, M57 D30 02, M57 D30 T2, M57 U2
- Rover M47R
- Land Rover M47

12/15.4/16.0/1.3' 1283g

■ Juego de puesta a punto para motores diésel BMW N47/N47S

904G11



Juego para puesta a punto de BMW, N47, N47S 4 cilindros en línea 2.0 TD

Contenido:

- Útil de bloqueo del volante para BMW: 4 cilindros en línea 2.0 TD
- Útil de bloqueo del árbol de levas para BMW: 4 cilindros en línea 2.0 TD
- Útil de bloqueo del cigüeñal para BMW: 4 cilindros en línea 2.0 TD
- Útil de bloqueo de la bomba de inyección para BMW: 4 cilindros en línea 2.0 TD

Modelos:

- 118d A (E88), 118d M (E88), 118d A (E81), 118d LCI (E87), 120d (E81), 120d (E82), 120d LCI (E87), 120d (E88), 123d (E81), 123d LCI (E87), 123d M (E88), 123d A (E88), 316d M LCI (E90), 318d M LCI (E88), 318d A LCI (E88), 318d M LCI (E91), 318d A LCI (E91), 320d M LCI (E90), 320d A LCI (E90), 320d xDrive (E90), 320d M LCI (E91), 320d A LCI (E91), 320d M (E92), 320d A (E92), 320d M (E93), 320d A (E93), 320d xDrive A (E92), 320d xDrive M (E92), 320D Efficient Dynamics M LCI (E90), 520d SE M (F10), 520d SE A (F10), 520d M (F10), 520d A (F10), 520d M (F11), 520d A (F11), x1 SDrive 18d M (E84), x1 SDrive 18d A (E84), x1 SDrive 20d M (E84), x1 SDrive 20d A (E84), x1 XDrive 20d M (E84), x1 XDrive 20d A (E84), x1 XDrive 23d A (E84), X3 2.0d M LCI (E83), X3 2.0d M LCI (E83)

Códigos de motor:

- N47 D20, N47 D20 00, N47 D20 01, N47 D20 TO, N47 D20 UO

10/9.5/10.5/0.8' 950g

■ Juego de puesta a punto para BMW N42, N46, N46T

908G9



Instalación y extracción del árbol de levas y su correcta alineación.

Comprobación y ajuste de la puesta a punto.

Modelos:

- BMW: 118/120 E81, E82, E87 (2004-2009); 318/320 E90, E91, E93 (2005-2009); Z4 E85, E86 (2004-2009); X3 E83 (2005-2009); 316/COMPACT E46 (2001-2005); 318/COMPACT E46 (2001-2007)

Códigos de motor:

- N42 / N46 / N46T B18, B18A, B20, B20A, B20B

10/23.8/24.8/1.5' 2400g



Juego de puesta a punto para BMW N42/N46

918G3



- Instalación y extracción de árboles de levas y árboles de levas de admisión variable y su correcta alineación en Valvetronic System.
- Aplicable a: E87: 118i / 120i ; N46
- E46: 316i / 316ti / 318i / 318ti ;
- N42 E90 / E91: 318i / 320i ;
- N46 E85: Z4 , 2,0i ; N46



5/19.0/20.0/0.8' 3700g

Juego de puesta a punto para BMW N40/N45/N45T

906G5



- Aplicable a: BMW N40 y N45(T) Twin Cam motor de gasolina en BMW.
- Serie 1: 116. E81/E87.
- Serie 3: 316i E46/E90. 316Ci E46. 316ti. E46.
- Contenido: Placa de retención VANOS.
- Placa de retención de árbol de levas (Admisión).
- Placa de retención de árbol de levas (Escape).
- Útil de bloqueo para el tensor de la cadena de distribución.
- Pasador de bloqueo del volante.
- Tornillo para bloquear el retenedor del árbol de levas.



10/20.0/21.0/1.3' 2000g

Juego de puesta a punto para BMW N51/N52/N53/N54

912G5



Motores de gasolina BMW 2.5 y 3.0 Valvetronic (N51, N52, N52K, N55) o inyección directa (N53, N54.)

Modelos:

- **BMW:** 125i, 128i, 130i, 135i and first M Coupé (E81, E82, E87, E88); 320si, 323i, 325i, 328i, 330i, 335i, Alpina B3, B3S Bi Turbo (E90, E91, E92, E93, F30); 523i, 525i, 528i, 530i, 535i, 535GT (E60, E61, F07, F10, F11); 630i, 640i, (E63, E64, F06, F12, F13); 730i, 730Li, 740i, 740Li, (E65, E66, F01); X1drive25i, X1drive28i, (E84); X3 2.5i, X3 2.5si, X3 3.0i, X3 3.0si, X3drive28i, X3drive35i (E83, F25); X5 3.0si, X5drive30i, X5drive35i, (E70); X6drive35i (E71); Z4 2.5i, Z4 2.5si, Z4 3.0si, Z4sdrive23i, Z4sdrive30i, Z4sdrive35i, Z4sdrive35si (E85, E86, E89)

Códigos de motor:

- N51 / N52 / N52K / N53 / N54 / N55



4/24.0/25.0/2.0' 6000g

Juego de puesta a punto para BMW, Mini, Citroen, Peugeot

905G12



Para instalar o extraer la cadena de distribución.

El kit incluye los útiles para alinear el eje de compensación, bloquear el árbol de levas y tensar la cadena de distribución.

Aplicable a:

- **BMW** 118i E87 (2004-2007); 120i E87 (2004-2007); 316i E46 (2001-2005); 316ti Compact E46 (2001-2005); 318i E46 (2001-2007); 318ti Compact E46 (2001-2005); 318i E90 (2005-2008); 320i E90 (2005-2008); 520i E60 (2004-2008); Z4 2.0 E85 (2004-2008); X3 2.0i E83 (2005-2008); 116i E81 E87 (2003-2008); 316i E46 E90 (2001-2008); 316Ci E46 (2001-2006); 316ti E46 (2001-2005); 128i E82 (2007-2008); 130i E81 E87 (2005-2008); 135iS E82 (2007-2008); 323i E90 E91 E92 E93 (2004-2008); 325i/xi E90 E91 E92 E93 (2004-2008); 328i/xi E90 E91 E92 E93 (2004-2008); 330i/xi E90 E91 E92 E93 (2004-2008); 335i/xi E90 E91 E92 E93 (2005-2008); 523i/Li E60 E61 (2004-2008); 525i/Li/xi E60 E61 (2004-2008); 528i/xi E60 E61 (2006-2008); 530i/Li/xi E60 E61 (2005-2008); 535i/xi E60 E61 (2006-2008); 630i E63 E64 (2004-2008); 730i/Li E65 E66 (2004-2008); X3 2.5/3.0 E83 (2006-2008); X5 3.0 E70 (2006-2008); Z4 2.5/3.0 E85 E86 (2005-2008)
- **Mini:** Cooper/S 1.4/1.6 (2006-2009); One (2007-2009)
- **Citroën:** C4 Picasso 1.4/1.6 (2008-2009); C4 1.4/1.6 (2009)
- **Peugeot:** 207/207CC 1.6/1.6 GT THP/1.6 GTi THP/1.6 THP/1.6 VTi/1.4 VTi (2006-2009); 308 1.6 THP 150 (2007-2009)

12/11.4/12.0/1.3' 950g

Juego de puesta a punto para Mercedes-Benz M271

904G18

NEW



Aplicable a: CLK 200K (W209), C 180K, C200K, C 230K (W203), C Sportcoupe C 160K, C 180K, C 200K, C 230K, E 200K (W211), SLK 200K (R171), C 180K (W204), CLC 180K, CLC 200K, C 180 CGI, C 200CGI, C 250CGI (W204), E 200CGI, E 250CGI (W212, C207)

Códigos de motor: E18ML (02-), DE18ML (03-05), E16ML (08-), DE18LA (09-)

6/17.1/18.1/2.6' 2850g



■ Juego de puesta a punto para Mercedes-Benz

906G7 NEW



Juego de bloqueo de volante y árbol de levas para motores diésel y gasolina 2.2 y 2.7 CDI

Modelos:

Mercedes 190, 190E-16, E-,C-,M-,S-,SL-,V-Class/Vito, G-Wagon, Sprinter, Viano, Vito, CLK, SLK, E290D Turbo, 208/210, 308/310/408/410, 512D/612D, 812D
Jeep Grand Cherokee 2.7 CRD (01-05)
Chrysler PT Cruiser 2.2 CRD (02-05)

Códigos de motor:

EDJ
102.920/921/940/941/942/943/944/945/946/947/948/950/951/955/956/958
/960/961/970/973/974/975/97;
104.943/944/945/980/981/990/991/994/995/996; 104.941/942/922(AMG)
111.920/921/940/941/942/943/944/945/946/947/948/950/951/955/956/958
/960/961/970/973/974/975/97; 119.960/970/971/974/975/980/981/985;
120.980/981/982/983; 601.912/913/962/940/941; 602.940/980/982/984;
603.912/913/960/963/971/972; 604.910/912/915/917;
605.910/911/912/960/962; 606.910/961/962; 611.960/961/962/980
612.961/962/963/965/967/981; 613.960/961; 628.960/961/962;
646.951/961/962/963/982/983; 647.961; 648.960/961



20/22.5/23.5/1.6' 1125g

■ Juego de puesta a punto para VW, Audi

908G5



Para motores VAG: 2.8 V30, 2.7 Turbo, 4.2 V40, 4.2, 5.2 FSI, 2.4, 2.6, 2.7, 2.8, 4.2, 6.0 de gasolina y 2.5, 2.7, 3.0 TDI, 3.0 TDI diésel.

Modelos: Audi: 80, 80 Quattro, 100, 100 Quattro, 200, A4, A4 Cabrio, A4, Qattro, A6, A6 Allroad, A6 Quattro, A8, Allroad, Coupe Quattro, Q7, R8, RS4, RS6, S4, S4 Cabrio, S5, S5 Cabrio, S6, S8

VW: Bora, Golf Cabrio, Passat, Phaeton, Sharan, Tuareg

Códigos de motor:

Audi: ABC, AAH, AMX, APR, ATX, ACK, ALG, AQD, AYM, AKE, BCZ, BDG, BDH, BAU, BFC, AKN, AFB, BPP, BSG, BKN, BDV, AMM, APS, ALF, AGA, AJG, AML, APZ, ARJ, ASB, CAPA, AGB, AJK, ALW, ASM, APC, ARN, AGE, BVJ, BNG, AYM, BDH, BMZ, BMK, AZA, BES, ARE, BAT, Awn, ASG, ARS, ARU, AVN, AUW, AQF, ASE, BSB, BTH, AZC, BAS, BAR, BUN, BUG, BYH, BNS, ASJ, AZR, BUH, BRV, BCY, AGB, AZB, BHF, BBK, CAUA, BXA, ANK, AQJ, BSM, AQH, APU, DE, AWA, AFF, AHH, 1Z/AHU, AFN, AVG, BKE, AWX, BRB, AVB, AVF, ATJ, AJM, BVF, BRC, BRF, BNA, BRE, BLB, BPW, BVA, BVG, BUL, BPG, BPJ, BWE, BGB, AMB, BEX, AVJ, BFB, AJL, ANB, AWT, AEB, ALZ, ANA, AHL, ARM, ADP, APT, ARG, AVV, ADR, ALT, AFV

VW: BDH, BAU, AKN, AFB, BDN, AMX, BBG, AGE, AMX, APR, ATX, ACK, ALG, AQD, CARA, BMK, BAN, BRP, BTT, BAP, BRN, BAR, CASA, BUN, BKS, CASB, BHX, AXQ, BJN, ATU, AWG, AWF, AVG, AHU, AHH, AKN, BDH, BDG, AVF, AWX, AVB, AJM, ATJ, AEB, ANB, APU, ALZ, ADP, AHL, ARM, ANA, ADR, ARG, APT, AZM, AMX, SSG, ALG, AQD, ACK, AGE, AFN, Z1/AHU

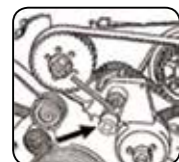
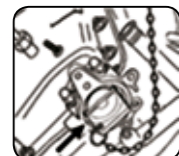

12/12.5/13.5/1.3' 1030g

■ Juego de puesta a punto para VW, Audi, Seat y Skoda

928G1



Juego completo para puesta a punto VAG. Aplicable a: VW, Audi, Seat y Skoda:

Gasolina:

1.2 6V - 1.2 12V - 1.4 - 1.6 - 1.8 - 1.8T - 2.0 16V

Audi: 80 - A2 - A3 - S3 - A4 - A6 - TT

Seat: Alhambra, Arosa, Cordoba, Ibiza, Inca, Leon, Toledo

Skoda: Fabia, Octavia (desde 1996)

VW: Bora, Caddy, Fox, Golf, Lupo, New Beetle, Passat, Polo, Sharan, Touran

Diésel:

1.2, 1.4, 1.9, 2.0 TDI PD

1.7, 1.9 D / TD / SDI / TDI

2.5 V6 TDI

Audi: 80, A2, A3, A4, A6, Cabrio (1995-2000)

Seat: Alhambra, Arosa, Altea, Cordoba, Ibiza, Inca, Leon, Toledo

Skoda: Fabia, Felicia, Octavia (1993-2005)

VW: Bora, Caddy, Golf, Lupo, New Beetle, Passat, Polo, Sharan, Transporter, Touran

Códigos de motor:

1Z / 1Y / 1X / 1F / 2E / AAZ / AAE / AAC / ABF / ABL / ABM / ABK /
ABT / ABS / ACE / AEK / AEF / AEH / AEB / AEG / ADY /
ADA / ADR / ADP / ADZ / ADL / AFF / AFN / AFT / AGG / AGR /
AGP / AGD / AGN / AGU / AHL / AHF / AHU / AHH / AHG / AHB /
AJQ / AJL / AJP / AJH / AKU / AKW / AKL / AKS / ALH / ALE / ALZ /
AMK / ANA / ANB / APK / APX / APU / APF / APG / APP / APY / APT /
AQM / AQA / AQX / AQY / ARX / ARY / ARZ / ARM / ARG / ASV /
ASY / ASX / ATM / ATU / AUM / AUQ / AUR / AVG / AVU / AVC /
AXW / AXA / AWU / AWG / AWT / AWC / AWF / AYQ / AYP / AYD /
AZH / AZJ / AZM / BAM / BEH / BFQ / BFS / BGU / AFK / AHW /
AKQ / APE / AQQ / AUA AUB / AXP / BBY / BBZ / BCA / BKY /
BUD / BXW / ARR / BAD / AJV / ARC / ATN / AUS / AVY / AZD /
BCB / AWY / BBM / BMD / AZQ / BME / BXV / BZG AFB / AKE /
AKN / AYM / BAU / BCZ / BDG / BDH / BFC / ANY / AYZ / AMF /
ATL / BAY / BHC / BMS / BNM / BNV / BWB / AJM / AMG / ANU /
ARL / ASZ / ATD / ATJ / AUY / AVB / AVF / AVQ / AWX / AXB /
AXC / AXR / BEW / BJB / BKC / BKE / BLS / BLT / BMT / BPX / BRB /
BRM / BRR / BRS / BRU / BSU / BSW / BTB / BUK / BVK / BXE /
BXF / AZV / BDJ / BDK / BGW / BHW / BKD / BKP / BLB / BMA /
BMM / BMN / BMP / BMR / BNA / BPW / BRC / BRE / BRF / BRT /
BUZ / BE / BVF / BVG / BVH / BWV

5/21.5/22.5/1.9' 4.3Kg

■ Juego de puesta a punto para VW, Audi, Seat y Skoda

929G1



- Para AUDI, SEAT, SKODA, VW.
- AUDI: A2(01-06), A3(01-07), A4(99-07), A6(98-07)
- SEAT: AROSA(99-05), IBIZA/CORDOBA(02-07), ALTEA(04-07), LEON(00-07), TOLEDO(04-07), ALHAMBRA(99-07)
- SKODA: FABIA(00-07), ROOMSTER(07), OCTAVIA(00-07), SUPERB(02-07)
- VW: LUPU(99-05), POLO(99-07), FOX(05-07), GOLF/BORA(98-07), JETTA(05-07), BEETLE(00-07), PASSAT(98-07), TOURAN(03-07), SHARAN(99-07), CADDY(03-07), TRANSPORTER(03-07)

5/21.5/22.5/2' 4230g

■ Kit de bloqueo y ajuste de árbol de levas y cigüeñal para VW

904G15

NEW



- Para instalar o extraer el árbol de levas; Comprobación y ajuste de puesta a punto; Aplicable a:
- VW: Polo (02-07), Fox (05-08)
 - Seat: Ibiza (02-08), Cordoba (02-08).
 - Skoda: Fabia (02-07).
- Códigos de motor:
- VW: AWY, BMD, AZQ, BME
 - Seat: AWY, BMD
 - Skoda: AWY, BMD, AZQ, BME

24/17.0/18.0/1.5' 708g

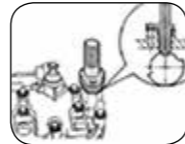

■ Juego de puesta a punto para VW

908G13

NEW



Modelos: VW T5 Touareg y Transporter 2.5 TDI PD y 4.9D /TDI

Códigos de motor:

BAC, BLK, BPD, AXD, AXE, BLJ, BNZ, BPC 2005-2009
AYH, BKW, BLE, BWF 2003-2009

2/15.5/16.5/0.8' 7750g

■ Juego de puesta a punto para VW / AUDI

907G13

NEW



Este juego incluye los útiles para el árbol de levas, el retenedor del tensor de cadena, pasadores de bloqueo y tornillo para el tensor.
Para motores de gasolina 2.0 FSI, TFSI 1.8 V16. 1.8 Cupra R gasolina, 1.4, 1.9, 2.0 TDI PD

Modelos:

- Audi A2, A3, A4, A4 Cabrio, A4 Quattro, A6, A6 Quattro, Cabrio, A8, S3, Allroad, RS6, TT
- Seat Alhambra, Altea, Altea XL, Cordoba, Ibiza, Leon, Toledo
- Skoda Fabia I-II, Octavia I-II, Octavia Tour, Roomster, Superb
- VW Beetle, Bora, Caddy, Caddy Maxi, Eos, Fox, Golf, Jetta, Lupo, Passat, Polo, Sharan, Tiguan, Touran, Transporter

Códigos de motor:

- Audi: BHC, ATL, AMF, BLX, BMB, BVY, BHD, BLY, AXW, BLR, BVZ, BKC, BLS, ASZ, ATD, AXR, AZV, BKD, BMN, BMM, AXX, BPY, BWA, AWA, AKE, AYM, BCZ, BDH, BAU, BDG, BFC, AFB, AKN, BRF, BVF, BNA, BRE, BLB, BVA, BVG, BUL, AVJ, BFB, AMB, BEX, ALT, BDG, BCZ, BRD, BPJ, AWT, AKN, BCY, BRV, BAM, AUM, APX, ARY, AJQ, APP, AUQ, AVB, AVF, AWX, BKE, BRB, BRC, BPW, BWT, BYK, BBJ, ASN, BHZ, BZC, CDLB, ARH, ARX, AGU, AQA, ARZ, AGN, APG, ANB, AJL, AEB, APU, ATP, AVV, ARG, ADR, AJP, AMK, APY, CDBL, BFV, BVR, AMU, BVP, APT, APJ, BFL, BFM
- Seat: BVH, BRT, BLR, BLY, BVZ, BVY, BLS, BJB, BKC, AZV, BKD, BMM, BMN, BGU, BSF, BSE, ASY, BMS, BNV, AMF, BNM, BMT, BPX, BUK, ASZ, ATD, AXR, BLT, AZL, AYP, BJX, BKV, BLZ, BBU, BXE, BFQ, AQX, APY, BAM, AMK, AUQ, APP, AJQ, ARY, AGN, APG, APT, BVK, ANU, AUY, BTB, BUH, BWA, BUY, BUZ, ARL, BWA, BWJ, AWC, AJH, AFK, AQQ, AUB, AKU, BKY, BBY, BXV, BBZ, AFH, AUA, AUB, APE, BXW, AZD, BCB, AUS, AMK, AHW, BCA, AXP, AGZ, BWA1,
- Skoda: AMF, BNM, BNV, BMS, BSW, BLS, BVY, BLX, BVX, BUZ, BLR, BLY, BJB, BKC, BKD, AZV, BMN, BWA, AXR, AYM, BDG, AWT, AZM, ARX, AGU, ARZ, AUM, AUQ, AGN, AWT
- VW: ATD, AXR, BFS, AYD, AJM, ANU, ARL, ASZ, AUY, APF, AEH, AKL, AVU, BFQ, BLS, BSU, BJB, BGU, BSF, BSE, BST, BDJ, BUZ, BUY, BMM, BPY, BWA, BNM, AXW, BLR, BLY, BUX, BLX, BWA, AXX, BPY, BDK, BRU, BXE, BKC, BXF, AZT, BCA, BRM, AMF, ANY, BKP, BWV, BVE, BMR, BMA, BUZ, BMP, BJX, ASY, BAJ, BMS, BWB, BMT, BLT, BMS, AUR, BTB, BVK, BRT, BKD, AXQ, BHX, AVQ, AXB, AXC, BRR, BRS, BZY, BVX, BVZ, AZV, BMN, AVB, AWX, AVF, BHW, BGW, BNV, BAY, AVC, AUM, AUQ, ARZ, AGU, AQA, BUL, AGN, ALT, AWT, AEB, ANB, APU, ADR, ARG, APT, BBU, AWC, AJH, BVY, AXX

20/22.0/23.0/1.7' 1100g

■ **Juego de puesta a punto para VW**

906G6

NEW



- Diseñado específicamente para bloquear y alinear el árbol de levas.
- Aplicable a: VW-Transporter, LT, Crafter 2.4D, 2.5SDI, 2.5TDI, 2.5TDI Common Rail

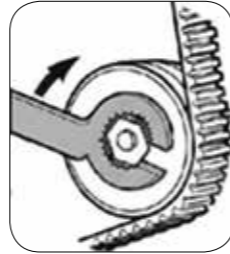

10/15.0/16.0/1.31' 1500g

■ **Juego de puesta a punto para VW / AUDI**

904G16

NEW



- Para comprobar y ajustar el árbol de levas al sustituir la correa o cadena de transmisión o durante cualquier otra reparación.
- Incluye la herramienta para ajuste de TDC, pasador de bloqueo, y útil para reloj comparador para el árbol de levas.
- Aplicable a motores de gasolina VW-AUDI 1.4L y 1.6L FSI:
Audi - A3 (03-10)
Skoda - Ocatvia (04-09), Fabia (07-09), Roomster (06-09), Superb (09-10)
VW - Polo (02-08), Golf (03-09), Golf Plus (05-09), Jetta (06-09), Passat (05-09), Touran (03-09).
Códigos de motor:
1.4 FSI: AXU / BKG / BLN
1.4 TFSI: BLG / BMY / BWK / CAVA / CAVB / CAVC / CAVD / CAVE / CAXA / CAXC / CDGA
1.6 FSI: BAG / BLF / BLP / BTS



10/12.0/13.0/1.2' 1200g

■ **Juego de puesta a punto para VW / AUDI**

914G5

NEW



- Juego completo para realizar servicio en la cadena de distribución, la culata, bomba HP y puesta a punto del motor.
- Para motores diesel VAG 2.7 - 3.0 TDi V6 y 4.0 - 4.2 TDi V8 common rail.
- Aplicable a: Audi - A4, A5, A6, A6 Allroad, A8, Q5, Q7, VW - Phaeton, Touareg

10/20.0/21.0/1.6' 2000g

■ **Útil para válvula central del árbol de levas VW / AUDI**

902G13

NEW



- Herramienta para instalar o extraer la válvula central para ajustar el árbol de levas.
- Aplicable a: Audi A3 (desde 2003).A4.A5.Q5 , VW Passat (desde 2006). Passat CC (desde 2006)



50/13.0/14.0/1.2' 250g

■ **Kit para alinear árbol de levas en Audi V6**

902G6



- Para Audi 3.0L, V6 30V
- Para Audi A4 y 2002 ~ 2004; Audi A4 Cabrio (03-09); Audi A6 (01-08) y Audi A8 (03-09)
- Códigos de motor: ASN, BBJ y AVK



5/12.5/13.5/0.5' 2.1kg

■ **Juego de bloqueo de poleas del árbol de levas VW**

9G1206



Motores de 4 cilindros 16V inyección:

Modelos:

- Audi: A2 1.4 (2000-2005)
- Código de motor: AUA
- Seat: Arosa 1.4 16V; Ibiza 1.4 16V; Cordoba 1.4 16V; Toledo 1.4/1.6 16V; Leon 1.4/1.6 16V; Inca 1.4 16V (1999-2005)
- Código de motor: AFK - AHW - APE - AQQ - AUA - AUB - AUS - AXP - AZD - BBY - BBZ - BCA - BCB
- Skoda: Fabia 1.4 16V; Octavia 1.4 16V (1999-2002)
- Código de motor: AUA - AUB - AXP
- Volkswagen: Lupo 1.4/1.6 16V; Lupo 1.4 FSI 16V; Polo 1.4 / 1.6 16V; Polo Classic 1.4 16V; Golf / Bora 1.4 / 1.6 16V; Beetle 1.4 16V; Caddy 1.4 16V (1997-2005)
- Código de motor: AFK - AHW - AJV - AKQ - APE - AQQ - AUA - AUB - ATN - AUS - AXP - AZD - BCA - BCB



60/22.5/23.5/1' 375g

■ Juego de bloqueo de árbol de levas VAG TDI PD

906G4



Modelos:

- **Audi:** A2 1.4 TDi PD (2002-2006); A3 1.9 2.0 TDi PD (2002-2006); A4 1.2 TDi PD (2002-2005); A4 1.9 2.0 TDi PD (2004-2008); A6 1.9 TDi PD (2002-2005)
- **Seat:** Altea 1.9 SDi TDi (2005-2008); Leon 1.9 2.0 TDi PD (2005-2008); Toledo 1.9 SDi TDi (2005-2008)
- **Skoda:** Fabia 1.4 TDi PD (2003-2006); Octavia II 2.0 TDi PD (2003-2006)
- **VW:** Beetle 1.9 TDi PD (2002-2008); Bora 1.9 TDi PD (2002-2008); Fox 1.4 TDi PD (2002-2008); Golf 1.9 TDi PD (2002-2008); Lupo 1.4 TDi PD (2002-2008); Polo 1.4, 1.9 TDi PD (2002-2008); Sharan 1.9 TDi PD (2002-2008)

Códigos de motor:

- **Audi:** AMF / ASZ / ATD / AVB / AVF / AWX / AXR / AZV / BHC / BKC / BKD / BKE / BLB / BMN / BNA / BPW / BRB / BRC / BRD / BRE / BRF / BUY / BVA / BVF / BVG
- **Seat:** AMF / AZV / BKD
- **Skoda:** AMF / AZV / BKD
- **VW:** AJM / AMF / ANU / ARL / ASZ / ATD / AUY / AVB / AVF / AWX / AXR / BAY / BMS / BNM / BNV / BWB

40/19.0/20.0/2.1' 415g

■ Juego de puesta a punto para VW, Audi

902G2



Para motores 1.9, 2.0 TDI PD

Contenido:

Pasador de bloqueo para la bomba de inyección. Útil de bloqueo del tensor. Útil de bloqueo del cigüeñal.

- **Códigos de motor:** BKD, BJB, BKE, BLB, BMA, BMM, BMP, BMR, BNA, BPW, BRE, BRF, BRC, BUZ, BVE, BXE



6/14/15/1.6' 234g

■ Juego de puesta a punto para Peugeot, Citroen

935G1

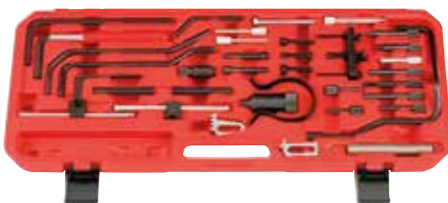

Juego completo para puesta a punto para vehículos Peugeot y Citroën:

Motores:

Gasolina: 1.0, 1.1, 1.4, 1.6, 1.8, 1.9, 2.0 és 1.6, 1.8, 2.0, 2.2 16V Diésel: 1.4, 1.5, 1.7, 1.8, 1.9, 2.1, 2.5 D,TD,TDI, 1.4, 1.6, 2.0, 2.2 HDI

Modelos:

Citroen: AX, BX, ZX, XM, Saxo, Xara, Synergie, Berlingo, Dispatch, Jumper, C2, C3, C5, C9

Peugeot: 106, 205, 206, 306, 307, 405, 406, 407, 605, 807, Express, Expert, Partner, Boxer

Códigos de motor:

EW, DW8, DW9, DW10, DW12, TU, TUD, XU, XUD

5/18.0/19.0/2' 3.6Kg

■ Juego de puesta a punto para Ford y PSA

911G7

NEW



Juego para cambiar la correa de distribución en motores de gasolina 1.8 y 2.0 16V. Incluye bloqueo de volante y tensor así como útil para el ajuste de la polea del tensor.

Citroën:

- C5 1.8 / 2.0 HPI (2002-2005)
- Xsara 2.0 16V (2002-2005)
- Xsara Picasso 1.8 / 2.0 16V (2002-2005)

Peugeot:

- 406 1.8 16V (2000-2004)
- 807 2.0 16V (2002-2005)

Códigos de motor:

- 1.8 16V: EW7J4(6FZ)
- 2.0 16V: EW10A(RFJ), EW10J4S(RFK), EW10J4, EW10J4/L5, EW10J4R/L5, EW10J4/L4/5(RFN/RFR), EW10(RFN)
- 2.0 HPI: EW10D(RLZ)
- 2.2 16V: EW12J4/L5(3FZ)

10/15.0/16.0/1.6' 1500g

■ Útil de bloqueo de poleas

9G0606



De uso universal para bloquear poleas de árbol de levas o bomba de inyección al sustituir la correa de distribución.

24/24/25/2.5' 990g

■ Juego de puesta a punto para Fiat 1.2 8V & 1.4 16V

910G7

NEW



Este juego contiene un útil para bloquear el cigüeñal, Placa de ajuste del árbol de levas y tensor para correa de los motores 1.2, y un útil adicional para bloquear la polea dentada y alinear correctamente el árbol de levas de los motores 1.4 VVT.

Modelos:

- **Fiat:** 500 (2007-2012); Idea (2004-2012); Linea (2007-2011); Grande Punto (2007-2012); Doblo/Cargo (2005-2010); Panda EVO2 (2005-2008); Punto EVO (2009-2012)

- **Lancia:** Ypsilon (2006-2011); Musa (2005-2012)

- **Ford:** Ka (2009-2012)

Códigos de motor:

- 1.2 8V - 169A4.000, 169A4.000 (FP4), 199A4.000
- 1.2 8V - 188A4.000 (EVO2)
- 1.4 16V - 199A7.000, 350A1.000

10/10.0/11.0/0.8' 1000g

■ Juego de puesta a punto para FIAT 934G1



Juego completo de puesta a punto para Fiat/Alfa Romeo/Lancia

Alfa Romeo Gasolina:

- 145/146/147/155/156 1.4/1.6 Twin Spark
- 145/146/155/156/Spider/GTV 1.8 Twin Spark
- 145/146/147/155/156/Spider/GTV 2.0 Twin Spark, Códigos de motor: AR 323.01, 672.04, 162.01, 323.10
- 155 2.5i, Código de motor 673.01
- 155 2.5 V6, Código de motor AR 324.01

Fiat Gasolina:

- Punto/Brava/Bravo/Stilo/ 1.2 16V, Códigos de motor: 176B9.000, 182B2.000, 188A5.000
 - Brava/Bravo 1.4 12V, Códigos de motor: 182 A3.000, 182 A5.000
 - Brava/Bravo 1.6 16V
 - Stilo 1.6 16V
 - Bravo 1.8 16V, Código de motor 182 A2.000
 - Marea/Marea Weekend/Multipla 1.6 16V, Códigos de motor: 182 A4.000, 182 A6.000, 182 B6.000
 - Tipo Coupe 2.0 16V/Turbo, Códigos de motor: 836 A3.000, 175 A1.000
 - Marea/Marea Weekend/Barchetta 1.8 16V, Código de motor 182 A2.000
- ### Fiat Diesel:
- Ulysse 1.8/2.0/2.0 Turbo/Ducato 2.0, Códigos de motor: LFW, RFU, RGX, RFW
 - Bravo/Marea/Marea Weekend/Coupe 2.0 20V, Códigos de motor: 182 A1.000, 175 A3.000
 - Bravo/Marea/Marea Weekend/Multipla 1.9 D/TD/JTD, Códigos de motor: 182 A7.000 (TD 100), 182 A8.000 (TD 75), 182 B4.000, 185 A6.000, 188 A3.000, 192 A1.000, 192 A3.000
 - Barchetta/Coupe 1.8 16V
 - Punto 1.7D/TD/Cat & EGR, Códigos de motor: 176 B3.000, 176 A3.000, 176 A5.000
 - Tipo/Tempira/Ducato 1.9D
 - Tipo/Tempira/Ducato 1.9TD
 - Delta 1.6
 - Ulysse/Scudo/Ducato 1.9 D/TD, Códigos de motor: D8B, D9B, DHX, DJY
 - Ulysse 2.1TD 12V
 - Marea/Weekend 2.4JTD, Códigos de motor: 182 A7.000 (TD 100), 182 A8.000 (TD 75), 182 B4.000, 185 A6.000, 188 A3.000, 192 A1.000, 192 A3.000

Lancia Gasolina:

- Ypsilon 1.4 12V, Códigos de motor: 182 A3.000, 182 A5.000
- Ulysse 2.0 16V, Código de motor RFV

5/23.4/24.4/1.7' 4680g

■ Juego de puesta a punto para VOLVO 912G10 NEW



Sirve para alinear el árbol de levas en motores Volvo de 4, 5 y 6 cilindros Twin Cam Volvo (NO 3.2L) hasta 2006.

Contenido:

- Placa para el árbol de levas
- 2 Presillas para las cubiertas de las válvulas
- Útil para alinear el árbol de levas
- Pin de bloqueo del cigüeñal
- 2 Tornillos de 85 mm M7 x 1.0
- 2 Tornillos de 110 mm M7 x 1.0

Modelos:

Volvo 700, 800, 850, 900, 960, C70, S40, S60, S70, S80, S90, V70 (hasta 2000), V70XC, XC70, V90, XC90.

Códigos de motor:

B4164S, B4164S2, B4184, B4184S, B4184S10, B4184S2, B4184S3, B4184S9, B4184SJ, B4194T, B4194T2, B4204S, B4204S2, B4204T, B4204T2, B4204T2 CVVT, B4204T3, B4204T3, B4204T4, B4204T5, B5202FS, B5204FS, B5204FT, B5204T2, B5204T3, B5204T4, B5204T5, B5234FS, B5234FT, B5234T2, B5234T3, B5234T4, B5234T5, B5234T6, B5234T7, B5234T8, B5234T9, B5244S, B5244S2, B5244S4, B5244S5, B5244S6, B5244S7, B5244SG, B5244SG2, B5244T, B5244T2, B5244T3, B5244T4, B5244T5, B5244T7, B5252FS, B5254FS LH 3.2, B5254FS M 4.3, B5254FS M 4.4, B5254S DENSO, B5254T, B5254T2, B5254T3, B5254T4, B6244FS, B6254FS, B6254GS, B6284T, B6294S, B6294S2, B6294T, B6304FS, B6304FS2, B6304GS, B6304S3, GB5252S, D4192T2.

4/22.0/23.0/1.6' 5500g

■ Juego de bloqueo de poleas TOYOTA 915G1



- De uso universal para múltiples tipos de poleas tanto dentadas como perforadas y tanto de árbol de levas como de cigüeñal.

La llave se ajusta desde 32mm hasta 75mm
Con cuadradillo de 1/2"

16/18.3/20.5/2.2' 1140g



■ Llave de bloqueo de poleas Universal

9G0603



Sirve para bloquear el árbol de levas mientras se suelta o aprieta el tornillo central de la polea

Para la mayoría de coches asiáticos: NISSAN, TOYOTA etc.



24/21.8/22.5/1.5'  895g

■ Barra de impacto con cuadradillo de 1/2"

9G0712



Para soltar la polea del cigüeñal de un golpe

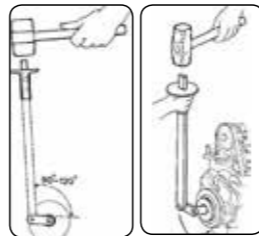

12/18.0/19.0/0.9'  1375g

■ Llave de bloqueo del cigüeñal para VW / AUDI

9G0616

NEW

- Esta llave sirve para bloquear la polea del cigüeñal para colocar el tornillo centrador de manera precisa.
- Longitud de 810mm (32" pulgadas), con 4 pines de 5mm y 42mm de separación entre éstos.
- Aplicable a: Audi A3 (desde 2004), motor 1.8 lts. TFSI (de transmisión de cadena), también para Audi A4 / A5 / Q5 (desde 2009), motor 2.0 lts. TFSI (de transmisión de cadena).



6/15.0/16.0/1.1'  2290g

■ Útil para bloqueo de poleas de correa dentada

9G0708



Se adapta perfectamente a todo tipo de poleas dentadas y las bloquea para quitar o poner los tornillos centrales. Al ser de goma, no daña los componentes.

Ideal para árbol de levas, filtros de gasolina, alternadores, bombas de agua etc. Y también para motores eléctricos como compresores, maquinaria etc.



30/18.5/19.5/2.8'  615g

■ Útil para bloqueo de poleas de correa lisa

9G0709



Se adapta perfectamente a todo tipo de poleas lisas y las bloquea para quitar o poner los tornillos centrales. Al ser de goma, no daña los componentes.

Ideal para árbol de levas, filtros de gasolina, alternadores, bombas de agua etc. Y también para motores eléctricos como compresores, maquinaria etc.

30/17.5/18.5/2.8'  583g

■ Llave para poleas de bombas de agua VAG

9G0704



- Para bloquear las poleas de la bomba de agua en motores VW y Audi



36/19.8/20.8/2.1'  550g



■ Juego para termoventiladores viscosos MB y BMW

907G3



Estas llaves especiales permiten trabajar en zonas de difícil acceso de forma cómoda.

La llave de 36mm para el embrague del ventilador MB permite sacar las tuercas de bloqueo de los ventiladores termoviscosos de los vehículos Mercedes y Ford. Aplicable a motores Mercedes M111, OM604, OM605 y OM606 de las clases C y E.

La llave de bloqueo del embrague del ventilador Mercedes permite sujetar la polea de la bomba de agua mientras se suelta el ventilador del radiador.

La llave de bloqueo del embrague del ventilador BMW permite sujetar la polea de la bomba de agua mientras se suelta el ventilador del radiador.

Lleva agujeros de 38 y 44.5mm para BMW M10, M20, M30 etc.

La llave de bloqueo del embrague del ventilador Mercedes de 65mm sirve para desmontar dicho embrague. El perfil ultra delgado de la llave permite trabajar con comodidad en zonas estrechas. Aplicable a Mercedes M103, M104, M119 y M120.

La llave de bloqueo del embrague del ventilador BMW de 32mm permite sacar e instalar termoventiladores viscosos en BMW y Ford.

La llave universal de ajuste de la correa del ventilador sirve para los ventiladores y poleas de los radiadores de Mercedes-Benz, Nissan Quest y Mercury Villager. También sirve para la instalación y el ajuste de A/C. Incluye 3 llaves allen de 2.5, 8 y 10mm.

5/19.3/22.0/2.7' 3860g

■ Extractor para polea del árbol de levas VW / AUDI

905G4



Diseñado para extraer poleas de árbol de levas en motores de 4 y 6 cilindros en motores de gasolina V6 y V8 VW y Audi.

Brazos de 17mm y 23mm

Códigos de motor:

AEB, AHA, AKB, ALH, APB, APH, ART, ATC, ATQ, ATW, AUM, AUX, AUG, AWD, AWN, AWP



10/16.4/16.9/1.1' 1.64Kg

■ Juego de vasos para poleas de alternador de 22 Pzs.

922G3



• Aplicable a: VW, Audi, Seat, Mercedes Benz, Renault, BMW, Ford Renault, Fiat, etc....

- Composición: A. Vaso de 17mm HEX, B. Vaso de 22mm HEX, C. Vaso de 22x28mm HEX, D. Vaso de 21x28mm HEX, E. Vaso de 19x28mm HEX, F. Punta de 35mm redonda con 4 pin, G. Punta de 38mm HEX con 3 pin, H. Ø 17.6x15mm HEXx33D, I. Ø 19.2x15mm HEXx33D, J. Ø 19.3x22mm HEXx33D, K. 3/8" x M10x72mm y Ø14x12mm HEXx31D, L. 1/2"x T50x110mm y Ø19.5x17mm HEXx33D, M. 1/2"x M10x110mm y Ø19.5x17mm HEXx33D, N. Punta H10 con terminación de 10mm allen



4/8.7/9.7/0.87' 2169g

■ Útil para alternadores XZN M10

674



- 1 Vaso de 1/2" con punta XZN M10 x 110mm
- 1 Cilindro exterior dentado con muelle de reacción 33 dientes de Ø19mm-17mm hex.
- Aplicable a : VW-Audi, Skoda, Porsche, BMW, Ford, Mercedes-Benz etc.



100/18.2/19.2/1.5' 110mm 182g

■ Útil para alternadores T50

678



- 1 Vaso de 1/2" Torx T50x110mm
- 1 Cilindro exterior dentado con muelle de reacción de 33 dientes de Ø19mm-17mm hex.
- Aplicable a: Mercedes A Class.

100/21.2/22.2/1.5' 110mm 212g

■ **Extractor universal de polea dentada del árbol de levas**

905G18

NEW

- Bloquea la rueda dentada para sacar el tornillo o tuerca retenedor.
- Este útil permite extraer la rueda dentada del árbol de levas de una gran variedad de vehículos.
- Rango de ajuste: 45 – 70mm



■ **Juego de centradores de embragues de 17 Pzs.**

917T2

Para instalar embragues en casi todos los turismos y furgonetas. Incluye 7 adaptadores, un centrador de disco y un eje alineador así como 5 adaptadores métricos, dos adaptadores para disco de embrague y un eje alineador.

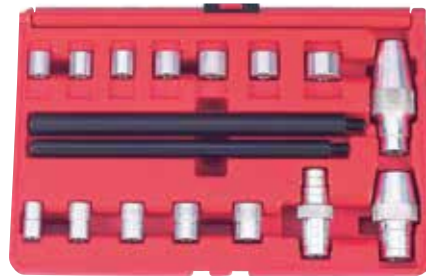

12/15.5/16.5/1.4' 1290g

■ **Kit para alinear embragues SAC**

929G2

NEW

- Kit profesional para desmontaje y montaje de todos los embragues autoajustables (SAC).
- En las operaciones de desmontaje y montaje el preajuste del plato de presión es imprescindible para evitar deformaciones en el embrague
- El plato de 6 brazos está diseñado para usarse con 3 o 4 puntos de anclaje para embragues con 6 o 8 agujeros de fijación.
- Aplicable a: VW, Audi, BMW, Ford, Mercedes-Benz, Renault, Vauxhall/Opel, Volvo...etc.



■ **Tensor para bomba de agua Opel 41mm**

9G0802

- Para motores GM OPEL.
- Proporciona un apriete fuerte en lugares de difícil acceso sin errores o deslizamientos.
- Medida: 41mm
1.2, 1.3, 1.4, 1.6, 1.6D, 1.8 (de 1987 en adelante).



48/13.9/14.9/2' 280g



■ **Tensor para bomba de agua Opel 46mm**

9G0803

- Para motores GM OPEL.
- Proporciona un apriete fuerte en lugares de difícil acceso sin errores o deslizamientos.
- Medida: 46mm
1.6 (hasta 1987), 1.7D, 1.8 (Hasta 1987), 2.0.



48/13.9/14.9/2' 280g

■ **Kit de tensado de la correa de distribución**

908G6

- Aplicable a : ALFA ROMEO, FIAT, CITROEN, PEUGEOT, RENAULT, VOLKSWAGEN.



10/14.0/15.0/1.2' 1330g

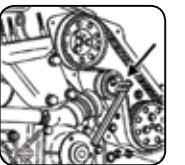
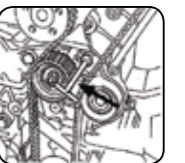

■ **Juego para tensado de correas de alternador VAG**

903G15

Aplicable a : Todo el grupo VAG.

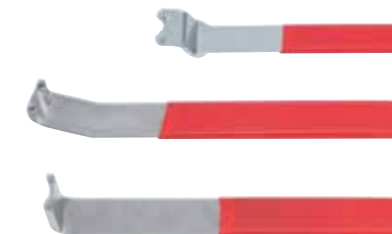

36/24.7/25.7/1.5' 670g



Kit para tensar la correa de distribución VAG

902G4

- Kit de 2 herramientas
- Para motores diésel VOLKSWAGEN de cuatro cilindros TDI/ PD/ SOHC.
- Incluidos:
GOLF /GOLF PLUS/ JUTTA/ PASSAT/
EOS TOURAN/ CADDY /CADDY MAXI.

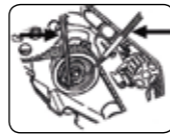

120/13.2/14.2/1' 110g

Kit para quitar y poner correas dentadas elásticas

902G9

- Aplicable a motores con correas elásticas dentadas como Alfa Romeo, BMW, Chrysler, Fiat, Ford, Mercedes, PSA, Seat, Skoda, Smart, Volvo, VW-Audi...etc
- Este kit permite quitar e instalar correas elásticas dentadas de forma rápida y fácil.



30/17.0/18.0/1.3' 567g

Comprobador de tensado de correa de distribución

9G0804

- Esta herramienta permite ajustar la tensión de la correa de distribución
- Compatible con la mayoría de correas de diversos grosores
- Fácil de usar.
- Sistema de medida similar al de los micrómetros claro, sencillo y preciso.



48/20.6/21.6/2' 335g

Comprobador de tensado de correa de distribución

9G0609

- Esta herramienta permite ajustar la tensión de la correa de distribución.
- Para todo tipo de correas, lisas, dentadas o trapezoidales.



40/10.5/11.5/0.9' 250g

Juego de 7 alicates para abrazaderas

907G1

Contenido

2 Alicates de boca basculante para abrazaderas. Alicates acodados, recto y de clic para abrazaderas así como un alicate con sirga para abrazaderas.



6/21.0/23.0/3.9' 3.5Kg

Juego de alicates para abrazaderas de 9 Pzs.

909G3

Contenido

2 Alicates de boca basculante para abrazaderas. Alicates acodados, recto y de clic para abrazaderas así como un alicate con sirga para abrazaderas. Gancho y destornillador para mangueras



6/15.9/16.9/3.0' 2650g



■ Alicate para abrazaderas

62518

- Para quitar o poner abrazaderas de presión.
- Las bocas son rotatorias para adaptarse a todos los ángulos.



72/18.0/19.0/2.6' Δ 250g

■ Alicate para abrazaderas VAG

62530

NEW

- Para manipular abrazaderas elásticas de tres puntas tipo W situadas en mangueras de combustible, ventilación de depósitos de carburante etc. Aplicable a VW, AUDI, SEAT, SKODA.



72/14.5/15.5/2.8' Δ 201g



■ Alicate de sirga para abrazaderas

9G0201



- Para abrazaderas en mangueras de agua, aceite o combustible.
- Con un cable flexible de 630mm que permite acceder a zonas difíciles y operar cómodamente.



36/22.6/23.6/3.5' Δ 630g

■ Alicate para abrazaderas (para VW, AUDI 2.0)

9G0208



- Diseño especial para las abrazaderas de la manguera de agua de los motores VW, AUDI 2.0 TDI
- Apertura Máxima: 55mm.
- La eslinga flexible de 630mm permite al usuario alcanzar, quitar y poner las abrazaderas fácilmente.



24/20.5/21.5/2.3' Δ 854g

■ Alicate para abrazaderas

9G0116

- Para cambiar abrazaderas autopresionantes de muelle en tubos de combustible, aceite, manguitos de radiador etc.



- El diseño del alicate permite comprimir y retener con seguridad la abrazadera.
- Para ALFA ROMEO, CITROEN, FIAT, FORD, HYUNDAI, LANCIA, MERCEDES, OPEL/ VAUXHALL, PEUGEOT, PORSCHE, RENAULT, SEAT, SKODA, TOYOTA, VOLVO, etc. Especialmente para las nuevas mangueras de combustible de VW-AUDI.



36/15.8/16.8/1.6' Δ 430g

■ Alicate para abrazaderas (acodado)

9G0109



- Diseño acodado para accesos difíciles.
- Bocas basculantes para mejor sujeción.
- Para abrazaderas tipo CLIC y CLIC-R.

40/11.4/12.4/2.4' Δ 285g



■ Alicate para abrazaderas CLIC-R

9G0104

- Para quitar o poner abrazaderas tipo CLIC y CLIC-R.



48/12.6/13.6/1.9' Δ 260g



■ Alicate para abrazaderas de apriete lateral

9G0117



- Para abrazaderas de 1 o 2 lengüetas.
- Puede cerrar las abrazaderas por el lateral o por la parte delantera adaptándose al espacio disponible.
- Tamaño: 230 mm



36/15.1/16.1/1.2' 419g

■ Útil para abrazaderas de 3/8"

9G0120

NEW



- Permite trabajar en espacios muy reducidos sin tener que desmontar más piezas.
- Mediante el giro del tornillo permite bloquear la abrazadera con máxima presión.
- Especialmente indicado para abrazaderas poco accesibles.



10/16/17/1.6' 190g

■ Alicate para manguitos

9G0106



- Para soltar manguitos de diámetros de 4mm a 21mm.
- Bocas antideslizantes para una fácil desconexión de las mangueras.

72/14.0/15.0/2.4' 194g

■ Mordazas para mangueras (8", 10" y 12")

9G0112



Permite mantener selladas las mangueras al realizar reparaciones
Evita tener que drenar el sistema de refrigeración al realizar reparaciones ahorrando tiempo y refrigerante.

Bocas basculantes.

Sistema de apriete por carraca que proporciona máxima fuerza de cierre en cualquier posición.

No usar en la manguera reforzada del radiador.

18/22.5/23.5/1.9' 1.25kg

Ref.	Largo
9G0112A	200mm
9G0112B	250mm
9G0112C	300mm



■ Juego de 3 pinzas para mangueras acodadas a 90°

903G18

NEW

Fabricadas en nylon.



- Los bordes de las bocas están redondeados para no dañar los refuerzos interiores de algunas mangueras.
- Se puede bloquear con una sola mano.
- Indicadas para mangueras de frenos, refrigerante, vacío o combustible.



24/9.0/10.0/2.4' 375g

■ Comprobador de anticongelante

9G4001

NEW



- Comprueba todos los tipos de anticongelante (Etileno Glicol) con el radiador frío o caliente.
- Dos escalas marcan el punto de congelación o ebullición del líquido refrigerante/anticongelante.



100/13/15.2/5.8' 130g

■ Refractómetro para baterías

9G0303



Largo de comprobación:
líquido de batería: 1.100~1.400
etileno glicol °C: -5 (12.4%) ~ -60 (66.6%)
propileno glicol °C: -5 (14.8%) ~ -50 (62.4%)

40/16.0/18.0/1.8' 400g

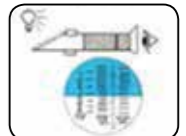
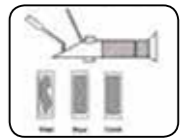

Comprobador de fugas en cilindros

905G10



- El líquido de control analiza el volumen de CO2 presente en el radiador.
 - Si el líquido se vuelve verde o amarillo estará indicando que el cilindro no es estanco.
- Rápido y fácil de usar con total fiabilidad



10/13.5/14.5/3.05' 1200g

Comprobador de presión de radiador universal

914G1



- Diseñado para detectar fugas en el sistema de refrigeración.
- Aplicable a: Suzuki, Isuzu, Lexus, Opel, Peugeot, Jeep, Rover, Citroen, Nissan, Mitsubishi, Mazda, Subaru, BMW, Renault, Fiat, Alfa Romeo, Toyota, Honda, Ford, GM, Chrysler, VW, Audi, Volvo, Saab, Mercedes Benz, Infiniti, Geo, etc
- Manómetro : 0~35 PSI, 25 bar



4/15.5/16.5/2.9' 3875g

Estetoscopio de mecánico

9G2204



- Proporciona un modo rápido y sencillo de localizar ruidos en el automóvil producidos por rodamientos o partes móviles dañadas, cuerpos extraños o fugas.

40/9.5/10.5/2.7' 200g

Detector electrónico de ruidos de automóvil

902G11

NEW



- Esta herramienta portátil ayuda a detectar rápidamente la fuente y localización de ruidos producidos por fallos en rodamientos, engranajes, transmisiones, válvulas, cilindros, cigüeñales, cajas de cambios, carrocería etc. Que se producen tras arrancar el motor.

- Es muy eficaz para localizar estos ruidos de manera precisa incluso en ambientes muy ruidosos.

40/9.0/10.0/3.1' 225g

Vacuómetro / sangrador de frenos

908G8



- El kit incluye bomba de vacío y los adaptadores necesarios para test de vacío y sangrado de frenos.

Manómetro de: 0 ~ 60 PSI / -30 ~ 0 PSI

6/11.0/12.0/2.4' 1.8kg

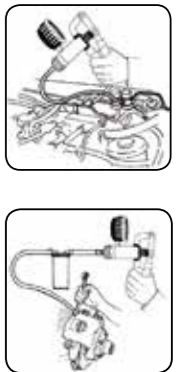

Compresímetro sencillo para gasolina

903G7



- Manómetro de 63mm de fácil lectura .
4 Escalas, 0-300 PSI, 21 kg/c M², 2100kpa.
- Latiguillo de 325mm con adaptadores de 14mm y 18mm.

20/15.2/16.2/1.2' 760g



■ Compresímetro para gasolina

909G1



Manómetro: 0~300 PSI, 0~21 kg/ cm², 20 bar
 Completo kit de comprobación para vehículos con bujías con roscas M10, M12, M14 y M18
 Con extensiones de M10, M12, M14 y M18
 Revisa el estado de válvulas, anillos de pistón, juntas y culatas.
 Sirve para turismos, furgonetas y motocicletas.



8/13.5/14.5/2' 1688g

■ Comprobador de presión de aceite

912G1



Ayuda a diagnosticar motores o bombas de aceite dañados así como averías en los sistemas de control de presión de aceite y los testigos de emergencia.

Enchufe rápido con válvula de descarga.

Manómetro: 0~150 PSI, 0~10 kg/ cm², 0~10 bar

Roscas: R/18 Din 2999, 1/8 x 27 Npt, 1/4 x 18 Npt, 3/8x 20 Unf, 1/2 x 20 Unf, M10 x10, M12 x1.5, M14 x1.5, M16x 1.5, M18 x1.5, 90° Acodada

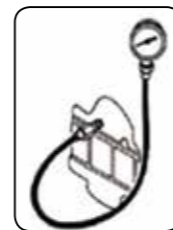

6/11.0/12.0/2.3' 1830g

■ Compresímetro para motores de gasolina de inyección

946G1



- Manómetro 0~120 PSI 8 bar
- Los adaptadores son compatibles con casi todos los inyectores Europeos, Japoneses o Americanos.



4/20.7/21.7/4' 5180g

■ Kit de limpieza y comprobación de inyectores

940G1



De uso universal
 Limpia inyectores, válvulas de admisión, cámara de combustión, sistema de vacío y resto de componentes.
 Comprueba la presión del motor y de la bomba de combustible así como la estanqueidad.



4/19.2/20.2/2.9' 4.8kg

■ Compresímetro para turismos diésel

913G1



Para motores de turismo diésel tanto de inyección directa como indirecta.
 Válvula de descarga que permite varias comprobaciones sin necesidad de volver a desmontar el compresímetro.

Latiguillo flexible de 355mm

Manómetro de 80mm con doble escala 0-1000 PSI y 0-70 bar.

6/16.3/17.3/2' 2720g

■ Compresímetro para vehículo industrial y agrícola diésel

916G2



Manómetro de 63mm relleno de glicerina con latiguillo reforzado hasta 4,500 psi.

Escala doble 0-1,000 PSI y 0-70 bar.

13 adaptadores (Deere, BMW etc)

3/15.9/16.9/1.5' 5300g

Comprobador de fugas en cilindros diésel

938G1

NEW



- Disponible kit de conversión a compresímetro

Incluye 3 kits de comprobación de fugas en cilindros adaptable a gran variedad de motores como HDi, TDCi y Pumpe Duse.

- Este conjunto abarca casi todos los modelos de turismo y furgoneta y contiene adaptadores para inyectores y calentadores aplicables a casi todos los motores.

- Adaptadores para calentadores de múltiples modelos diésel de Alfa, BMW, Chrysler, Daewoo, Fiat, Ford, Hyundai, Isuzu, LandRover, LDV, Mazda, Mercedes, Mitsubishi, Nissan, Opel, PSA, Renault, Saab, Suzuki, Toyota, VAG, Vauxhall, Volvo.

- Para inyectores: M20, M22, M24 & Ford Stanadyne injector plus

Comprobador de presión del sobrante de inyectores common rail

912G8

NEW



- Para medir la presión del sobrante de los inyectores common rail de motores con sistemas Bosch, VDO/Siemens y Delphi.

10/12.6/13.6/1.9' 1260g

Comprobador del volumen sobrante de inyectores common rail

902G8

- Comprueba el volumen de combustible sobrante en los inyectores common rail para identificar inyectores dañados.

- Puede trabajar sobre 6 inyectores a la vez

10/18.0/19.0/1.5' 1.8kg



Juego de 4 vasos para inyectores diésel

904G13

NEW



Sirven para extraer los inyectores una vez eliminado la cubierta y el conector.

- Para casi todos los tipos de inyectores de los motores más recientes.
- Vasos de 1/2" para inyectores Siemens y Bosch.
- Aplicable a motores Peugeot y Citroen 2.0 (110/135HP) HDI.
- Medidas: 25, 27, 29 30mm.
- Largo: 100 mm



10/15.0/16.0/1.2' 1488g

Juego de 4 vasos para inyectores diesel

904G3

- 4 vasos de 1/2" para cambiar inyectores diesel.
- Aplicable a: ALFA ROMEO, CHRYSLER, BMW, FORD, VW, MERCEDES, AUDI, OPEL, VAUXHALL, SEAT, VOLVO, ROVER y camiones VOLVO, MAN2.5TD y SCANIA HGVS.



Medida	Descripción	Largo
22mm	Vaso de 6 caras abierto	110mm
22mm	Vaso de 12 caras abierto	75mm
27mm	Vaso de 12 caras abierto	78mm
28mm	Vaso de 12 caras abierto	78mm

10/11.4/12.4/0.8' 1.141Kg

Extractor de inyectores Bosch diésel

903G19

NEW



- Permite sacar los inyectores individualmente sin desmontar el motor.

- Para extraer inyectores Bosch.

- Para Motores Mercedes CDI 2.1 l y 2.2 l.

- Aplicable a: Vito, Sprinter, Viano, C y E Class, CLC, CLK.



6/16/17/1.8' 2580g

■ Juego para extracción de inyectores (PSA HDI/JTD)

910G3



- Extractor para inyectores Common Rail para motores Peugeot, Citroen, Suzuki diesel HDI/JTD
- El Punte de tracción se ajusta perfectamente a los motores PSA.
- Sistema de fijación especial que ayuda a una rápida extracción del inyector.
- Aplicable a motores: PSA 2.0 & 2.2 HDI/JTD (110, 135 PS), HDI DW10 y DW12.



6/22.0/23.0/1.4' 3660g

■ Juego de extracción de inyectores diésel BMW

908G11



- Kit completo para extraer inyectores en motores BMW sin desmontar la culata.
- Equipado con un accesorio para soplado y limpieza del asiento del inyector.
- Para inyectores Bosch common rail montados en BMW
- Aplicable a :BMW Common Rail : M47TU, M57, M57TU, M87 y M87U.



2/13.0/13.8/0.9' 6500g

■ Juego de extracción de inyectores JTD

9G0119



- Extractor universal de 4 patas regulables para sacar inyectores en motores JTD.
- Para inyectores common rail.
- Aplicable a: FIAT, ALFA, OPEL, SAAB, SUZUKI.

8/19.0/20.0/1.8' 2375g

■ Juego de extracción de inyectores para Mercedes CDI

907G11



- Para sacar inyectores common rail atascados sin tener que desmontar la culata.
- Aplicable: Mercedes-Benz CDI motores 611, 612, 613, etc.



6/21.5/22.0/1.0' 3583g

■ Extractor de inyectores diésel para Mercedes CDI

903G17



- Especialmente diseñado para inyectores atascados.
- Sin necesidad de desmontar o usar mazas de impacto que podrían dañar el asiento del inyector.
- Aplicable a: Mercedes C-Class, E-class, Sprinter y Chrysler Grand Cherokee 27crd (año 2000 en adelante).
- Motores: OM 611, 612, 613, 646, 647 y 648

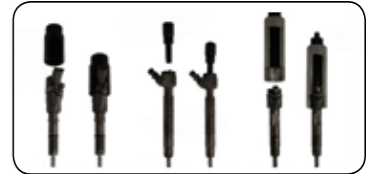

12/15.5/16.5/1.1' 1291g

■ Extractor de inyectores con maza de impacto para Mercedes CDI

909G5



- Para sacar inyectores atascados common rail sin desmontar el motor.
- Su sólida construcción permite acometer la extracción de inyectores muy atascados.
- Para motores Mercedes CDI OM 611, 612, 613 etc y motores DB CDI.
- Especificaciones:
Largo: 350mmL
Maza de 1.75kgs
Adaptador: M17x1
Adaptador: M27x1.0 para inyectores Bosch .
Adapador: M12x1.75P



6/20.0/21.0/1.5' 3333g

■ **Extractor de inyectores VAG diesel y gasolina (TDI & FSI)**

912G6



- Se fija al inyector mediante el Puente y dos garras y se extrae el inyector con la maza de impacto.
- El diseño especial de las dos garras lo hace especialmente eficaz para fijar el inyector.
- Aplicable a: VW, AUDI TDI, AUDI FSI, AUDI, SEAT, SKODA.



6/22.0/23.0/0.9' 3666g

■ **Juego de extracción de inyectores diesel Delphi y Bosch**

904G9



- Diseñado específicamente para sacar inyectores diesel Delphi y Bosch usando maza de impacto con rosca 5/8" UNF.
- Los adaptadores también se pueden usar con herramienta neumática para aflojar los inyectores mediante impulsos.
- El kit con los tres adaptadores más el útil de extracción permite el desmontaje de la parte interna de los inyectores Bosch.

18/18.5/19.0/1.0' 1027g

■ **Vaso de 33 dientes para bomba de inyección diésel MB**

9G0121

NEW



- Vaso de 33 dientes para instalar o extraer el retenedor de la válvula de presión de las bombas de inyección de diésel MRSF-ERE.
- Aplicable a: motores diésel Mercedes-Benz 601, 602, 603, 605, 606, 615, 616 y 617.

- Vaso: 1/2" x 33 Dientes

100/14.0/15.0/1.2' 83g



■ **Vaso para tuerca ranurada de pre-cámara diésel MB**

9G0122

NEW



- Sirve para reparar la pre-cámara de todos los motores Mercedes diesel posteriores a 1989.
- Motores diesel Mercedes: 601, 602, 602.91, 603, 604, 605, 606, 661, 662
- Vaso: 1/2" x 58 Dientes



50/15.0/16.0/1.0' 223g

■ **Vaso para el filtro de diesel (Motores HDi)**

9G0123

NEW



- Vaso especial necesario para sacar el filtro de combustible en los motores 2.1, 2.2 HDi engines.
- Aplicable a:
Citroën: C4 2.0 HDi 16v, C4 Picasso 2.0/2.2 HDi, C5/ C8 2.0/2.2 HDi 16V, Jumpy 2.0/ 2.2 HDi
Fiat: Scudo / Ulysse Mk II 2.0 JTD 16V
Ford: Focus/ Focus C-Max/Galaxy/Kuga/S-Max 2.0 TDCi
Peugeot: 307/308/407/607/807/Expert 2.0 HDi 16V
Volvo: C30/C70/S40 Mk II/V50 2.0 Diesel(136 HP)

- Vaso: 1/2" x 27mm

100/13.0/14.0/0.6' 139g



■ **Extractor de arandelas de inyector common rail**

9G0118



- Fácil extracción de las arandelas de cobre.
- Agujero interior de \varnothing 7mm.
- Largo: 230mm



20/16.0/17.0/1.2' 800g

■ Extractor para bomba de inyección diésel (BMW)

904G7



Grande: Extractor de bomba y del retenedor de la polea.
BMW motores diésel M74/M47T,
M57/M57TU 2.0 y 3.0 .

Pequeño: Extractor de bomba y del retenedor de la polea.
LAND ROVER FREELANDER y ROVER75
con motores Td4 y M47 2.0.

20/20.0/21.0/0.8' 980g

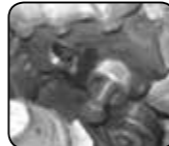
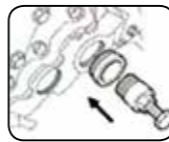

■ Extractor para bomba de inyección diésel (BMW)

9G1501



Herramienta diseñada para sujetar la cadena y la polea en su sitio al desmontar la bomba de inyección VP44 y la bomba de alta presión.

Motores BMW con inyectores common rail:
318D/COMPACT(E46), 320D/TD COMPACT(46), 330D(E46)
525D(E39), 525D(E60/E61), 530D(E39), 530D(E60/E61), 535D(E60/
E61), 730D(E38), X5 3.0D(E53)

20/11.0/12.0/0.5' 530g

■ Alicate para calentadores diesel (Recto)

9G1001



- Diseñados para extraer calentadores de difícil acceso sin causar daños al motor.
- Aplicable a: MERCEDES, BMW, VW, Audi... etc.

36/10.0/11.0/2.05' 277g

■ Alicate para calentadores diesel (Curvo)

9G1002



- Diseñados para extraer calentadores de difícil acceso sin causar daños al motor.
- Aplicable a: MERCEDES, BMW, VW, Audi... etc.

36/10.0/11.0/1.19' 277g



■ Pistola de impulsos de 1/4" para calentadores

909G6

NEW



- Afloja calentadores atascados mediante impulsos neumáticos controlados

- Vasos largos de 8, 9, 10, 11 y 12 mm

- También incluye un prolongador corto, uno largo y una junta cardánica de impacto así como la pistola de impulsos.

6/11.1/12.1/1.4' 1850g



■ Juego de extracción de calentadores de 3 Pzs.

903G16



Para escariar y limpiar la rosca entre el calentador y la cámara de pre-combustión.

Aplicable a: Pre calentadores de 10mm, bujías de incandescencia de 6 y 7mm.

24/14.0/15.0/1.6' 570g



■ Juego para extracción de calentadores

916G3



- Simplifica la extracción y desmontaje profesional de calentadores de motores diésel.
- Utilizable en la mayoría de motores
- Para extraer calentadores en buen estado y también dañados.
- Incluye:
 - Brocas para taladrar calentadores rotos de 7 x 5.5 mm y 9 x 5.5 mm.
 - Machos de M8 x 1.0, M10 x 1.0 y 1/4"-28UNF para reparar las roscas de asiento de los calentadores.
 - Giramachos.
 - Vaso E10 .



10/17.5/18.5/1.6' 1750g

■ Lapeador para asientos de inyectores diésel

907G7



Diseñado para limpiar y escariar asientos de inyectores common rail.
 Fresa recta de 15mm de uso universal.
 Fresa recta de 17mm para inyectores DELPHI / BOSCH (BMW / PSA / RENAULT / FORD).
 Fresa recta de 19mm para inyectores BOSCH (MERCEDES CRD)
 Fresa oblicua de 19mm para FIAT / IVECO.
 Mango T y guía.

20/19.2/19.7/2' 950g

■ Compresor de muelles de válvulas de 70-200mm.

62101



- Para turismos grandes o vehículos industriales.
- Rango de apertura: 70-200mm. Profundidad: 250mm.



8/26.4/27.4/1.7' 3.3Kg

■ Compresor de muelles de válvulas de 60-155mm

62102



- Para motores con árbol de levas en cabeza.
- Rango de apertura: 60-155mm. Profundidad: 150mm.



12/19.6/20.6/1' 1630g

■ Compresor de muelles de válvulas de 45-145mm

62104



- Para motores multiválvula diésel y gasolina. Especialmente indicado para accesos difíciles y culatas multiválvula con asientos profundos.
- Rango de apertura: 45-145mm. Profundidad: 240mm.



6/15/16/0.9' 2650g

■ Compresor de muelles de válvulas de 55-175mm

62107



Rango de apertura: 55-175mm.
 Profundidad: 165mm
 Para motores multiválvula diésel y gasolina. Especialmente indicado para accesos difíciles y culatas multiválvula con asientos profundos.
 Adaptadores de 25 y 30mm para accesos difíciles. Para uso general en motores OHC, OHV y CVH.



10/16.5/17.5/1.2' 1.65Kg

■ Compresor de muelles de válvulas de 35-142mm

62109

Para motores OHC, OHV y CVH. No es apto para motores con asientos de válvula muy profundos.

Garras reversibles. Además permite preseleccionar una medida para ajustar el cierre semiautomático de las garras.



20/17.5/18.5/2.1' 875g

■ Kit de 3 pinzas magnéticas para abrazaderas de válvulas

903G1

Estas pinzas magnéticas mantienen las abrazaderas sujetas a los imanes para su instalación. Además sirven para recuperar piezas pequeñas que se puedan soltar y caer en spartes inaccesibles del motor durante la reparación.



48/15.4/16.4/0.6' 320g

■ Alicete extra largo para retén de válvulas

9G0103

Para sacar retenes de válvulas en motores multiválvula. Las bocas tienen dentado longitudinal para evitar deslizamientos. La longitud de las bocas permite acceder a retenes profundos.



72/27.6/28.6/2.6' 380g

■ Ventosas para esmerilar válvulas

902G7

Diámetros de 29 y 35mm para válvulas grandes.
Diámetros de 16 y 21mm para válvulas pequeñas.

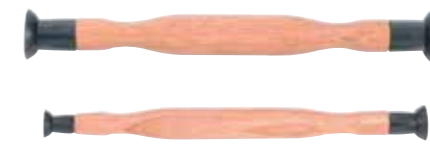

108/16.0/17.0/2.9' 100g

■ Lapeador de válvulas neumático

62114

1 Lapeador neumático
1 Ventosa de 40mm
1 Ventosa de 35mm
1 Ventosa de 30mm
1 Ventosa de 20mm

Presión de trabajo recomendada: 6 a 8 kg/cm². (85 psi a 100 psi)



12/17.0/18.0/1.2' 1730g

■ Goniómetros de pinza

9G1801 / 9G1801A

- **9G1801** cuadradillo de 1/2".
- **9G1801A** cuadradillo de 3/4".



24/12.1/13.1/2.1' 500g

■ Goniómetros magnéticos

9G1802 / 9G1802A

- **9G1802** cuadradillo de 1/2".
- **9G1802A** cuadradillo de 3/4".



24/11.3/12.3/2.1' 495g

■ Vasos XZN de 1/2" x 100mm para culatas (M9,M9.5,M10,M12,M14)

348100..



Ref.	Medida	mm	g	Aplicaciones
34810009	M9	100 mm	95	VW Golf / Jetta / Audi A4 , TT , A8 / Mercedes Benz M102, 103, 104, 110, 116, 117, 119, 120, 615, 616, 617 / TOYOTA MR2
348100095	M9.5	100 mm	102	FIAT
34810010	M10	100 mm	108	VW / Audi / Vauxhall / Opel / Mercedes (furgonetas) / Ford
34810012	M12	100 mm	151	TOYOTA Tercel / Mercedes-Benz / New Beetle / Ford / GM / VAG
34810014	M14	100 mm	187	Volkswagen / Ford / Chrysler / Rover

■ Vaso Ribe M10S de 1/2" para culatas VAG

34914010V



- 1/2" x 140mm.
- Para culatas de motores de Audi y VW-PASSAT



100/13.4/14.4/1.5' 134g

■ Vaso Torx hembra E12 x 150mm de 1/2" para culatas BMW

54615012B



Para BMW
Aplicable a: M42, M43, M44, M50, M52, M60, M62.



Ref.	Medida	mm	g	Ud/Caja
54615012B	E12	150	152	10

■ Juego de 4 rasquetas multiuso

904U1



- Estas rasquetas son útiles en múltiples tareas de reparación en el automóvil.



- Contiene 2 hojas de lija para limpiar las rasquetas
- Las rasquetas cortas son especialmente útiles para rascar con fuerza.
- Las rasquetas largas permiten alcanzar lugares estrechos y profundos.

10/11.8/12.8/1.6' 1180g

■ Juego de 3 rasquetas para culatas

903M1



- Medidas: 15, 20 y 30 mm
- Acero inoxidable endurecido.
- Mango de madera
- Afiladas en la parte frontal



72/14.2/15.2/2.1' 200g

■ Lapeador de cilindros grande de 2" a 7"

9G0901



- Ajustable de 50 a 75mm
- Tamaño de las piedras: 100 x 10 x 8mm (3 piedras)



24/17.0/18.0/2.5' 680g

■ Lapeador de cilindros pequeño de 3/4" a 2.1/2"

9G0902



- Ajustable de 19 a 63mm
- Tamaño de las piedras: 28,5 x 5 x 3mm (3 piedras)



72/8.5/9.5/1.6' 120g

■ **Ceñidores de segmentos**

620



Ref.	mm	<i>l</i> Pulgadas	Envase	g
6202080	40-80	2	50/7.8/8.8/1'	156
6203175	90-175	3	50/17.9/18.9/1.3'	365
6206175	90-175	6	20/12.0/13.0/1.6'	600



■ **Mordaza grip de cadena para filtros de aceite**

61901A



- Cr-Mo
- Con cadena de 18"

20/16.5/17.5/1.1' 825g

■ **Llave de cadena para filtros de aceite**

61911

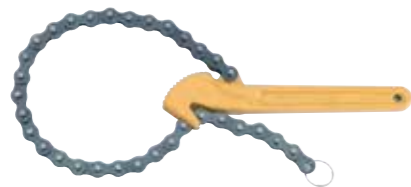

- Para filtros de entre 40 y 120mm.

60/22.0/23.0/0.82' 410g

■ **Llave de cadena de 20"**

61914



20/20.0/21.0/0.78' 1kg

■ **Llave de 3 patas para filtros de aceite**

61904



- Para filtros de entre 65mm y 110mm
- Con cuadradillo de 3/8".

36/21.3/22.3/1.2' 590g



■ **Llave de 3 patas planas para filtros de aceite**

61904A



- Con cuadradillo de 1/2" y 3/8"
- Para filtros de 63 a 102 mm.

36/15.0/16.0/1.2' 415g



■ **Llave autoajustable para filtros de aceite**

9B0701



- Garras de acero antideslizantes y autoajustables.
- Con cuadradillo de 3/8".
- Para filtros de moto y coche entre 80 y 98mm

Ref.	Envase	g
9B0701	48/18.1/19.1/1.7'	380



■ Llave de 3 patas para filtros de aceite

9B0704



- Cuadradillo de 1/2".
- Para filtros de 95 a 165 mm.

10/14.0/15.0/0.81' 1.4Kg



■ Llave de 3 patas para filtros de aceite

9B0704A



- Cuadradillo de 1/2".
- Para filtros de 80 a 120 mm.

36/19.3/20.3/1.2' 536g

■ Llave de filtro de correa

61908



Con correa de goma antideslizante de 420mm
Capacidad: 130 mm de diámetro

48/16.2/17.2/2.2' 338g

■ Llave ajustable para filtros de aceite

61909

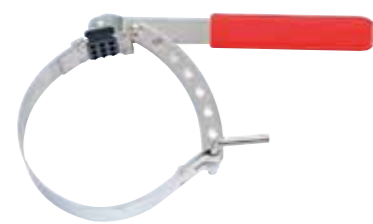

- Capacidad: 80-110 mm de diámetro

50/17.5/18.5/4.83' 350g

■ Llaves de fleje de acero para filtros de aceite

61910

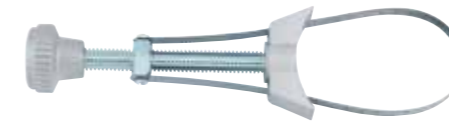

- Fleje de acero de alta resistencia
- Fundición de aluminio

Ref.	Capacidad mm	 g
61910	65-110	210
61910L	110-155	230



* Flejes de repuesto Ref.: **61910-D** y **61910L-D**

■ Tenaza para filtros de aceite

639250



Ref.	Diámetros mm	 Envase	<i>l</i> mm	 g
639250	60-90	60/21.2/22/2.1'	250	354



■ Mordaza grip para filtros de aceite

639230



Ref.	Diámetros mm	 Envase	<i>l</i> mm	 g
639230	53-118mm	40/19.5/20.5/1.7'	230	480

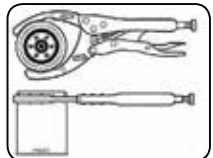

■ Llave para filtro de aceite de 27mm FORD / PSA

61927

NEW



- Esta llave está diseñada para extraer filtros de aceite de difícil acceso.
- Aplicable a:
FORD / PSA 2.0 L Durotorq TDCI / HDI (DW10C) y 2.2 L Durotorq TDCI / HDI (DW12C) diesel - S Max, Mondeo, Galaxy, y motores adaptados a Euro 6 a partir de 2010.

30/19/20/1.5' 680g

■ **Juego de cazoletas para filtros de aceite**
61916 / 61917

61916



5/18.2/19.2/2.4'
3940g

61917



3/21/22/3.2'
7060g



Diametro mm	Caras	61916	61917
66	6	X	X
65	14		X
65-67	14		X
68	14		X
73	14		X
74	15		X
74-76	15	X	X
75-77	15		X
76	12	X	X
76	14	X	X
76	30		X
76	8	X	X
78	15		X
80	15		X
80-82	15		X
86	16	X	X
86	18	X	X
90	15		X
92	10	X	X
93	15	X	X
93	36		X
93	45	X	X
95	15		X
96	18	X	X
100	15		X
106	15	X	X
108	15	X	X
108	18	X	X
LLAVE DE FILTROS		X	X
ADAPTADOR		X	X

■ **Llaves de cazoleta de 1/2" para filtros de aceite**
631

• Cuadradillo de 1/2"



Ref.	mm	C.	Aplicación
6317414	74	14	BMW, AUDI, WOLKSWAGEN, OPEL, AUSTIN
6317408	74	8	FIAT
6317915	79	15	DAIHATSU, FORD
6318614	86	14	MAZDA, MITSUBISHI
6318915	89	15	HONDA, MITSUBISHI
6319115	91	15	TOYOTA, NISSAN
6319112	91	12	CITROEN, PEUGEOT, RENAULT
6319115B	91	15	GM, FORD, CHRYSLER, LANCIA, FIAT
6319215	92	15	HONDA, TOYOTA

MOTOR

■ **Juego de 5 cazoletas de 3/8" para filtros de aceite**
61920B

- Cuadradillo de 3/8"
- Medidas: 24mm, 27mm, 32mm, 36mm y 38mm
- Aplicable a: CADILLAC, MERCEDES, VAUXHALL/ OPEL, BMW, FORD.



20/16/17/0.65' 800g

■ **Llave de cárter de 8 y 10mm**
9U0706

Llave de cuadradillo de Cromo-Vanadio para cárter de 8 y 10mm.
Para quitar los tapones del cárter de los automóviles de las marcas francesas, fundamentalmente.



50/17.3/18.3/1.84' 344g

■ Llave múltiple para cárter

890220



- Medidas: 8.7mm, 9.5 mm, 10.5 mm, 11.5 mm, 13 mm, 6.8 mm, 15.2 mm, 16.5 mm, 19.7 mm
- Largo: 220mm

20/8.8/9.8/0.56' 440g

■ Juego de 5 llaves para drenaje de cárter

5051



Contenido

- 5 Llaves de drenaje de cárter
- 5051-1 17mm Hexagonal
- 5051-2 10mm Hexagonal
- 5051-3 9mm Hexagonal
- 5051-4 8mm Cuadrada
- 5051-5 3/8" Cuadrada



25/11.5/12.5/0.64' 460g

■ Juego de 15 llaves de 3/8" para tapones de cárter

915G2



- ▲ 9.5mm
- 10mm
- 8, 9.5, 11, 12, 13 mm
- 8, 9, 9.5, 10, 12, 14, 17 mm

10/20.0/21.0/1.3' 750g



■ Vaso de 1/2" M16H para caja de cambios VAG

348...T



Ref.	Medida	l mm	g	Ud./Caja
34805516T	M16H	55	142	10
34810016T	M16H	100	270	10

- Para soltar el tapón de drenaje de aceite de las cajas de cambios de Audi A3, A4, A6; VW Golf IV, LT.



■ Kit de 64 Pzs. para reparación del cárter

964G1

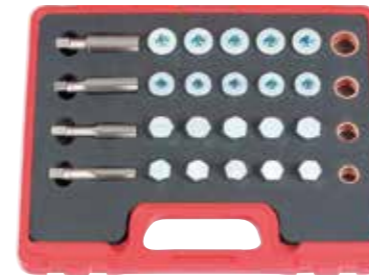

Con machos, arandelas y tapones nuevos para rehacer las roscas de los cárteres.

- M13x1.5P, M15x1.5P, M17x1.5P, M20x1.5P
- 1 Macho por cada paso de rosca calidad SKS3
- 5 Tapones de cárter por cada paso de rosca
- 10 Arandelas de cobre de cada medida



12/18.0/19.0/2.2' 1460g

■ Útil para drenar el filtro de aceite (Toyota y Lexus)

61923



- Facilita un trabajo limpio y profesional al cambiar el filtro de aceite.
- Aplicable a modelos de Toyota y Lexus de 4 a 8 cilindros posteriores a 2006.



50/8.0/8.5/0.48' 180g

■ Útil para drenar el filtro de aceite (VW)

61925



- Facilita un trabajo limpio y profesional al cambiar el filtro de aceite.
- Aplicable a múltiples VW 2.0 Golf V 2.0T 2.5 Golf V (todos) 2.5T Jetta V (todos) 2.0T Passat B (todos) 2.0T



40/7.4/8.4/3.6' Δ 170g

■ Embudo para aceite con perforador

61928

NEW



- Evita totalmente los derrames de aceite.
- Mejora y hace más eficiente el proceso de cambio de aceite.
- Base transparente para visualizar el flujo de aceite durante el proceso de cambio.
- El perforador asegura la sujeción de las garrafas de aceite.
- Perfora el sellado de las garrafas y evita que caigan al motor.
- El perforado ahorra tiempo y evita derrames no deseados de aceite o aditivos.
- Con filtro de malla metálica para retener las impurezas sin dilatar el tiempo de trabajo.
- Con rosca hembra M37 x P3.0 compatible con la mayoría de boquillas de embudo del mercado.
- Aplicable a: Lexus, Toyota, Scion, VW, Audi, BMW, Mercedes, Benz, Porsche, Chevrolet, Geo, Volvo

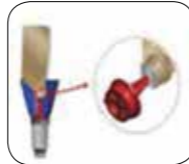

10/3.0/4.0/1.57' Δ 340g

■ Varilla de nivel aceite de transmisión

9G1803 / 9G1804

9G1803

Varilla de nivel de aceite para transmisión 722.6

100/16.5/17.5/1.9' Δ 165g

9G1804

Varilla de nivel de aceite para transmisión 716.5, 722.7

100/11.6/13.0/1.9' Δ 116g



■ Varilla de nivel de aceite

9G1805 / 9G1806

9G1805

- Varilla recta para medir el nivel de aceite del motor

100/5.4/6.4/1.4' Δ 54g

9G1806

- Varilla acodada para medir el nivel de aceite del motor.

100/5.2/6.2/1.4' Δ 52g



■ Alicate para conectores de manguera de combustible

9G0716

NEW



- Para reemplazar conectores de manguera de combustible fácilmente.
- Para cambiar conectores de filtros de combustible.
- Previene las pérdidas de combustible en conectores dañados.
- Aplicable a: Audi, VW, GM, Mercedes incluida clase M, Toyota, Fiat, Opel.

48/16.0/17.0/2.4' Δ 335g



■ Llave ajustable para el depósito de combustible

9G0713

NEW

- Rango de apertura: 122~199mm, para adaptarse a los diversos tamaños de las bridas del tanque de combustible.
- El diseño especial de las bocas se adapta a todas las bridas.
- Con cuadradillo de 3/8".

24/16.0/17.0/1.2' Δ 497g



■ Bomba manual para trasvase de combustible

63302



- Para transferir combustible de un automóvil a otro.
- Para bombear combustible al calentador.
- Para drenar depósitos de combustible.

50/15.3/16.3/2.6' 306g

■ Kit para desconectar el aire acondicionado

907G10



Para los tubos del aire acondicionado, combustible, radiador etc.
Diámetros : 1/4", 5/16", 3/8", 1/2", 5/8", 3/4", 7/8"



72/9.5/10.5/2.7 120g

■ Juego de 4 obturadores para tubos metálicos

904G12

NEW



- Taponan conductos de acero desconectados. Sirven para todos los fluidos del automóvil. Fácil instalación con muelle retráctil.
- Previenen pérdidas de fluidos y contaminación
- Tamaños: Banjo (10.4&18mm) 3/8", 5/16", 1/2"



48/7.5/8.5/2.5' 157g

■ Obturador universal para tubos metálicos

9G4301

NEW



- Tapona y sella conductos metálicos del automóvil. Especialmente indicado para el circuito de frenado, refrigeración, combustible A/C, etc.
- Sella totalmente los conductos metálicos gracias al tornillo de presión.
- Previene pérdidas de fluidos y contaminación en el area de trabajo.
- Tamaños: Banjo (10.4&18mm) 3/8", 5/16", 1/2"

72/14.8/15.8/2.65' 205g

■ Juego de 7 vasos para sonda Lambda

907G2



- Diseñados para sacar sensores de oxígeno.

Contenido:

- 01- Vaso para sonda lambda de 1/2" x 22 x 50mm
- 02- Vaso de perfil bajo de 3/8" x 22 x 30mm
- 03- Vaso hexagonal para sonda lambda de 3/8" x 22 x 80mm
- 04- Vaso hexagonal vacuómetro de 3/8" x 22 x 90mm
- 05- Vaso de 1" y 1-1/16" de 3/8" x 74mm
- 06- Vaso hexagonal de 1/2" x 29mm x 90mm
- 907G2P3** - Vaso de 12 caras para sensor de temperatura GM 1/2" x 27mm x 78mm



10/21.4/22.4/1.2' 2140g

■ Vaso extra largo de 1/2" para sonda lambda de 22mm

44315022



- Para quitar o poner sondas lambda con asiento profundo.
- Cuadrado de 1/2"
- Vaso hexagonal de 22 x 150mm.
- Aplicable a: MERCEDES-BENZ C/E, 602, 605, 606 VW/AUDI/ SKODA/SEAT, BMW. FORD, OPEL, ROVER, VOLVO.

48/17.4/18.4/1.51' 362g

■ Vaso de 1/2" x 22mm para vacuómetro

44322



Ref.	Medida	l mm	g	Ud/Caja
44322	22	85	230	10

■ Kit para extracción de airbag

907G5



Kit para extracción de airbag del volante en VW Passat, Jetta, Golf, Beetle, Mercedes-Benz, BMW

20/11.6/12.6/2' 580g



■ Kit de 7 ganchos para muelles y piezas

907U1



Ideales para tensar y coloar todo tipo de muelles presentes en los automóviles al realizar reparaciones.

También sirven para recoger piezas y tuercas pequeñas que puedan haber caído en lugares inaccesibles etc.

10/9.7/10.7/1.3' 970g

■ Traviesa para motores de 500 kg.

9G0612



- Ajustable en altura y anchura para adaptarse a las dimensiones de cada vehículo y motor.
- Incluye un tornillo lateral para ajustar la distribución del peso de la forma más adecuada.
- Capacidad: 500 kg

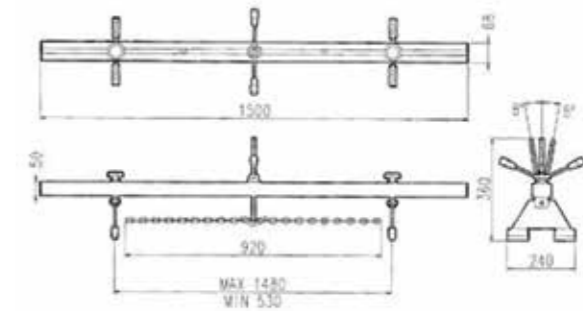

1/11.5/13.1/1' 11.5kg

■ Kit de para quitar el embrague del compresor de A/C

912G11

NEW



- Para reemplazar embragues de los computadores HR-6, DA-6 y V5 de los compresores de A/C.
- Para compresores Sanden SD505, 507, 508, 510, 575, 708 y 709.
- El plato de tracción tiene perforaciones doble y triple para adaptarse a la mayoría de los embragues.

12/15.0/16.0/1.28' 1250g

■ Luz de 12V ultravioleta

902G10

NEW



- Para detector fugas del A/C.
- Luz de 12V UV de alta intensidad.
- Cable largo .
- Detecta todos los tintes.
- Incluye gafas de protección UV.

20/10.4/11.0/2' 520g



■ Juego de 12 extractores para terminales

912C1

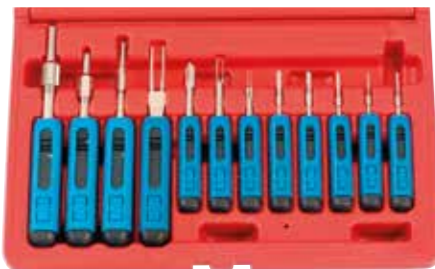

Para reparar conexiones eléctricas dañadas en el automóvil.

Este juego es válido para el 80% de los terminales que se utilizan en turismos.



Aplicable a: FORD, BMW, MERCEDES BENZ, OPEL, VW, FIAT, MAN, SAAB, RENAULT, DIAMLER CHRYSLER, PORSCHE, PSA, SKODA, AUDI, MAZDA, TOYOTA.

10/7.7/8.7/1.1' 770g

■ Juego de 23 extractores para terminales

923C1

NEW



- Diseñados para sacar los terminales de los conectores de plástico sin causar daños.
- Aplicables a casi todos los terminales instalados en los cableados de la mayoría de los vehículos.

12/19.0/20.0/4.0' 1583g

■ Juego de extracción de radios de 20 Pzs.

920C1



- Para extraer radios sin causar desperfectos.
- Para ALFA, FIAT, VW, FORD, RENAULT, AUDI, GRUNDIG, BLAUPUNKT, BMW, BECKER, MERCEDES-BENZ, PORSCHE, OPEL, SKODA, PEUGEOT, JVC, PIONEER, CLARION.

100/17.5/18.5/1.2' 175g

■ Juego de extracción de radios de 52 Pzs.

952C1

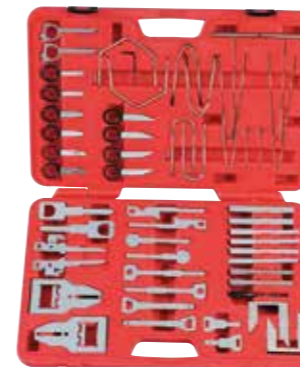

Contenido:

- 2 Ganchos U para extracción de radio (FORD/VW/AUDI/GRUNDIG/BLAUPUNKT)
- 1 Llave pentagonal para extracción de radio (BMW)
- 4 Llaves para extracción de radio (VW/AUDI/BECKER/MERCEDES-BENZ)
- 2 Llaves para extracción de radio (MERCEDES BENZ/PORSCHE/BECKER)
- 2 Llaves para extracción de radio (VW)
- 1 Llave allen para extracción de radio (BMW/OPEL)
- 2 Llaves para extracción de radio (NEW BECKER)
- 2 Llaves para extracción de radio (NEW SKODA)
- 2 Llaves para extracción de radio (NEW BLAUPUNKT)
- 2 Llaves para extracción de radio (FIAT BRAVA)
- 2 Ganchos U para extracción de radio (OPEL DOPPEL-KUGEL-INBUS)
- 6 Llaves para extracción de radio (MERCEDES BENZ & BMW)
- 2 Llaves para extracción de radio (KENWOOD II 1998-2001)
- 2 Llaves para extracción de radio (SONY II AB 2002)
- 2 Llaves para extracción de radio (KENWOOD III AB 2002)
- 2 Llaves para extracción de radios (PIONEER & JVC)
- 2 Llaves para extracción de radio (SONY I BIS 2001)
- 2 Llaves para extracción de radio (PANASONIC)
- 2 Llaves para extracción de radio (KENWOOD I BIS 1998)
- 2 Llaves para extracción de radio (KENWOOD MASK)
- 2 Llaves para extracción de radio (CLARION-NEW)
- 2 Llaves para extracción de radio (CLARION (ALT))
- 2 Llaves para extracción de radio (PANASONIC 2006)
- 2 Llaves para extracción de radio (SONY IDIC 2005)

10 / 13.4 / 14.4 / 2.8' 1340g

■ Extractor para bornas de batería

9C2002



- Las garras se ajustan perfectamente a los bornes de las baterías y el tornillo de presión permite extraerlos sin causar daños.
- También se puede usar para rodamientos de alternador y limpiaparabrisas.



60/23.6/24.6/1.8' 393g

■ Cepillo para bornes de batería

9U3002



- Diseñado para limpiar los bornes de las baterías.

120/9.7/10.7/1.7' Δ 81g

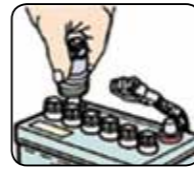

■ Asa para baterías

9C2005



- Se ajusta sola a baterías con anchos de 115 a 178mm.
- Permite manipular y transportar la batería con una sola mano.



24/13.0/14.0/1.9' Δ 541g

■ Densímetro para baterías

9G4005

NEW



- Muy útil para extender la vida de las baterías.
- Detecta el nivel de carga.
- Aplicable a 6, 12 y 24 V.



100/13/15.2/5.8" Δ 130g

■ Tester de automoción

88422



- Para 6 a 24V
- Cuerpo metálico con diodo luminoso.
- Cable de 850mm con pinza.

100/3.6/4.6/2.5' Δ 36g



■ Tester de automoción sin cable

88425



- Detecta de 3 a 28 voltios.
- No necesita tierra.
- Pilas incluidas.

60/3.8/4.8/0.78' Δ 63g



■ Tester de automoción

88427



- Detecta de 3 a 48 voltios.
- Las luces LED muestran la polaridad

100/8.4/9.4/3.2' Δ 84g



■ Tester de automoción HD

88431



Comprueba 6-12-24 V
Cable de 1.5m con pinza aislada y reforzada.
La empuñadura de plástico se ilumina al detectar corriente.

60/13.4/14.4/3.4' Δ 223g



■ Tester ajustable sin contacto

88407



- Rango de medida: 12~600V AC 50~60HZ.
- Localiza cables dañados o activos a través de las paredes u otros obstáculos.
- Sensibilidad ajustable
- Indicador de LED y sonoro
- 2 pilas LR44, 1.5V incluidas.



100/5.4/6.4/1.3' 54g

■ Tester universal

88408



- Rango de medida: 6~400V AC / DC.
- Para uso general en industria o talleres
- Led con indicaciones de:
± 6, 12, 24, 50, 120, 220V
- 400V AC / DC=LED
(ED): 30sec
I max: 30mA



60/8.5/9.5/2.7' 142g

■ Juego de 2 guías 0-30V

902C1

NEW



- Para diámetros de cable :de Ø 1.5 a Ø 4.5
- Voltaje de 0V a 30V
- Carga máxima: 5 A



■ Juego de multiconectores

990C1



Se conectan rápida y fácilmente sin dañar cables o circuitos ni añadir impedancia. Compatible con cualquier multímetro de automoción.

Conectores de diagnóstico e inyección, SRS, airbag, sensor de temperatura del refrigerante, válvula mariposa, etc.



4/11.2/12.2/2.9' 2850g

■ Juego de pinzas y conectores para tester de 13pzs.

913C1

NEW



Aplicables a cualquier multímetro de automoción.



20/10.3/11.3/1.2' 515g

FORCE

PARTE L

HERRAMIENTAS PARA FRENOS Y SUSPENSIONES





■ Juego de 6 llaves para frenos

50612



Contenido

- 6 Llaves para frenos
- 6080610 1/4" Cuadrado x 10mm Cuadrado
- 6080608 1/4" Cuadrado x 5/16" Boca abierta
- 6080810 8mm Hexagonal x 10mm Hexagonal
- 6080911 9mm Hexagonal x 11mm Hexagonal
- 6080607 1/4" Hexagonal x 7mm Hexagonal
- 6081109 7/16" Boca abierta x 11/32" Cuadrado

 30/17.8/18.8/1.3'  593g



■ Alicate para muelles de tambor de freno

9B0101



El gancho tira del muelle mientras la estrella multiganchos se hace firme en el tambor. Para sistemas de 2 muelles.



 36/18.0/19.0/2.5'  500g



■ Alicate para muelles de freno

9B0102



Diseñado para uso profesional. Puntas delgadas con tracción de acción paralela. Incluye un vaso para frenos hidráulicos al final de la empuñadura.





 24/9.8/10.8/1.6'  410g

■ Alicate para muelles de freno con gancho

9B0103



- Para muelles de frenos de tambor.

 12/15.2/16.2/1'  1260g



Alicate para muelles del cable del freno de mano

9B0104



Para comprimir el muelle retenedor del freno de mano
Apropiado para sustituir el cable del freno de mano
Applicable a: VW, AUDI, BMW, CITROEN, NISSAN, PEUGEOT, RENAULT, ROVER, SEAT, etc.



72/16.4/17.4/1.6' 230g

Alicate para muelles de tambor de freno

9B0105



• Diseñado para sacar el muelle de retorno del freno.
Una punta tira del muelle mientras la otra se apoya en el tambor.



72/20.0/21.0/1.2' 280g

Alicate de sirga para frenos

9B0106



Ahorra tiempo y esfuerzo al sustituir cilindros y zapatas de freno.



24/17.6/18.6/2.7' 730g

Alicate para arandelas de muelle de frenos

9B0107



• Universal para todos los tambores de freno.
• Cuello en ángulo para acceso fácil a las arandelas elásticas de los frenos.
• Largo: 180.5mm.
• HRC43°~46°.
• Ángulo máximo: 50°.



40/10.0/11.0/1.05' 250g

Retenedor de muelles

9T0202



• Ayuda a sacar fácilmente los muelles de las zapatas de freno.

96/17.0/18.0/2' 150g



Comprobador de líquido de frenos

88502



• Comprueba la calidad del líquido de frenos.
• Una escala de 5 LED indica el porcentaje de agua contenido en el líquido de freno.
• Interpretación de los LED:
Verde: Pila cargada OK y líquido libre de agua.
Verde/Amarillo: Menos de un 1% de agua.
Verde/Amarillo/Amarillo: Aprox. 2% de agua.
Verde/Amarillo/Amarillo/Rojo: Aprox. 3% de agua.
Verde/Amarillo/Amarillo/Rojo/Rojo: Al menos 4% de agua.



100/7.0/8.0/1.5' 70g

Comprobador de presión del circuito de freno

924B2



Este kit contiene todos los adaptadores, manómetros y mangueras para comprobar los circuitos de freno con o sin ABS en Chrysler, Ford, GM, Jeep, etc.

Escala doble: 0-3,000 psi y 0-200 kg/cm2.
Manguera resistente hasta 4,500 psi.

Incluye 20 adaptadores entre ellos uno a 90° y otro a 45°.

3/10.1/11.1/1.5' 3370g

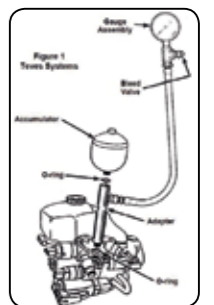

Vasos pentagonales de 1/2" de 14 y 19mm para frenos

65014 / 65019



- 14mm : Frenos traseros de Opel Astra G, Zafira, Smart
- 19mm: Para Bendixbrakes, Citroën, Peugeot y Renault

Vaso pentagonal de 10mm de 1/2" para frenos

65001



Ref.	Medida	l mm	g	Ud/Caja
65001		55	94	10

Juego de reposicionar pastillas traseras de 7 Pzs.

658

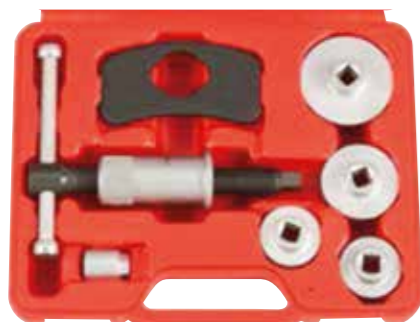

El juego se compone de un husillo, placa de bloqueo y 5 adaptadores.

Aplicable a: VW, AUDI, FORD, PEUGEOT, ROVER, NISSAN, SUBARU, HONDA, BMW, MITSUBISHI, TOYOTA, JAGUAR, MERCEDES, MAZDA.



12/16.3/17.3/1.3' 1360g

Juego de reposicionar pastillas traseras de 18 Pzs.

65805

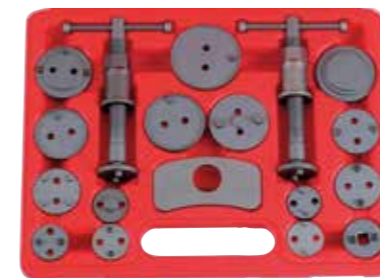

- Con una placa de bloqueo y 15 adaptadores. Compatible con la mayoría de los automóviles.
- Aplicable a: Citroen, AUDI, FIAT, FORD, ISUZU, HONDA, JAGUAR, BMW, NISSAN, MITSUBISHI, VW, SAAB, MAZDA, TOYOTA...etc.



10/25.5/26.5/1.87' 2480g

Juego de reposicionar pastillas traseras de 27 Pzs.

927B2

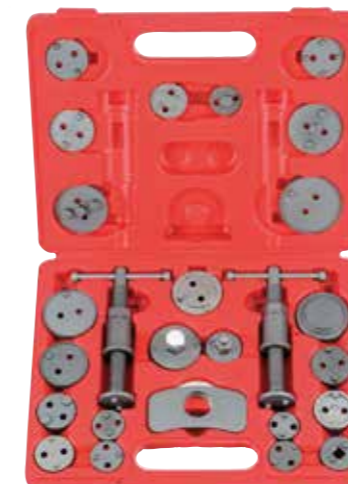

- Un tornillo con rosca a derecha y otro a izquierda.
- Aplicable a: GM, MERCEDES, ALFA ROMEO, CITROEN, FIAT, VW, AUDI, FORD, ROVER, LINCOLN, NISSAN, SUBARU, HONDA, BMW, MITSUBISHI, TOYOTA, PEUGEOT, OPEL, RENAULT, JAGUAR, MAZDA, VOLVO, VAUXHALL, SAAB, LANCIA.

5/16.0/17.0/1' 3kg

Juego de reposicionar pastillas neumático de 16 Pzs.

65815 / 65815A



Presión de trabajo: 5 ~ 8 kg/m²; Nunca más de 14 kg/m².
Aplicable a: Citroen, AUDI, FIAT, FORD, ISUZU, HONDA, JAGUAR, BMW, NISSAN, MITSUBISHI, VW, SAAB, MAZDA, TOYOTA...etc.

65815A Pistola neumática suelta

5/15.7/16.7/2' 3140g



Llaves de rueda

677



Ref.	Medidas	<i>l</i> mm	 g	 Ud/Caja	O.D. mm
6772224	22x24	400	1300	5	19
6772427	24x27	400	1320	5	19
6772732	27x32	400	1380	5	19
6773032	30x32	400	1440	5	19

Barra para llave de rueda

677



Ref.	O.D.	<i>l</i> mm	 g	 Envase
67701	19mm	630	1400	15/21/22/0.32'
67701400	19mm	400	890	10 25/22/23/0.2'

Llave de rueda de cruz

681B400



- 17; 19; 21; 22 mm y cuadradillo de 1/2".
- 400mm Cr-V forjado
- Acabado pulido



12/18.6/19.6/0.97' 1550g

Carraca rápida de 1/2" con torque para ruedas

681D515

NEW

- Saca rápida y fácilmente los tornillos atascados de las ruedas.
- Par de multiplicación de torque de 3.5 a 1.
- Solamente debe usarse para sacar tornillos ya que si se usara para apretarlos se podrían romper.
- Largo: 515 mm



10/23.0/24.01.1' 2300g

Juego de 3 vasos de torque hidráulico de impacto

4035



Diseñados para quitar y poner tornillos de rueda con rapidez y seguridad.
Vasos de 1/2" de 17, 19 y 21mm delgado.
Rango de torque : 115Nm±6% (85ft/lbs±6%)
Presión de trabajo de 90 Psi. (6.2 bar; 6.3kg/cm²; 62pa)
El par de salida de la llave de impacto debe estar entre 190 y 210 Nm. (140~155ft/lbs)

Vaso 24/30/31/1.1' 1250g

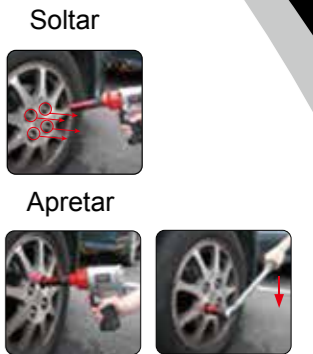

Juego de 4 vasos de torque hidráulico de impacto

4045



Diseñados para quitar y poner tornillos de rueda con rapidez y seguridad.
Vasos de 1/2" de 17, 19, 21 y 22mm delgado. Rango de torque : 115Nm±6% (85ft/lbs±6%)
Presión de trabajo de 90 Psi. (6.2 bar; 6.3kg/cm²; 62pa)
El par de salida de la llave de impacto debe estar entre 190 y 210 Nm. (140~155ft/lbs)

Vaso 12/19.0/20.0/0.75' 1583g

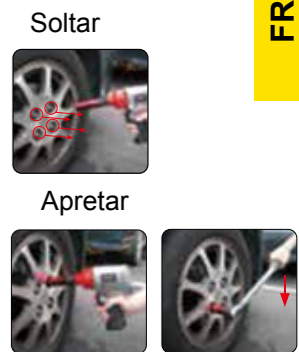

Tenaza para plomos de equilibrar

6821



- Instala, elimina, corta y crimpa plomos de equilibrar ruedas.

30/12.6/13.6/1.3' *l* 245mm 420g

Desmontadores de ruedas

750



Ref.	Largo mm	Peso
750200	200	162 g
750300	300	370 g
750500	500	732 g
750650	650	1160 g



Colocador de válvulas de rueda

9B0301



Ref.	Envase	g
9B0301	48/16.8/17.8/0.87'	350



Juego de 2 atornilladores de torque para válvula de rueda

902U3

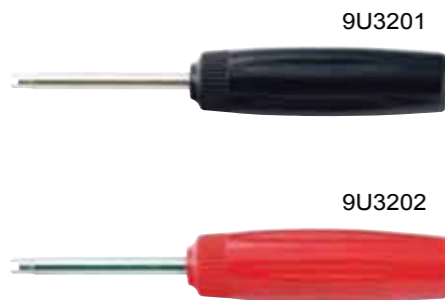

- Estos destornilladores tienen un par de torque limitado para evitar apretar en exceso las válvulas de rueda.
- Cada uno está limitado a un par determinado:
Rojo-25 Ncm (2.2 IN. LB)
Negro-45 Ncm (4 IN. LB)



100/12.0/13.0/1.8' 120g

Kit de reparación de pinchazos

904T4

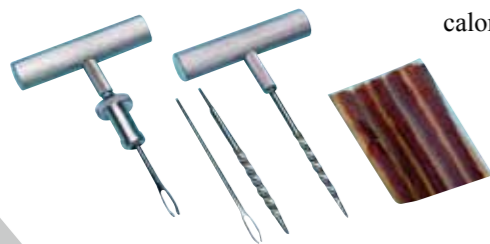

Para ruedas radiales.
Las mechas sirven para sellar el pinchazo mediante calor.



72/25.5/26.5/2.7' 354g

Juego de 5 Pzs. para suspensión trasera de VW, AUDI

905T4



- Para reemplazar los casquillos de montaje del eje trasero sin tener que desmontar el tren trasero.
- Permite colocar los casquillos con facilidad y precisión sin causar desperfectos.
- Aplicable a: Audi A3/ VW Golf IV/ Bora 1.4/ 1.6/ 1.8/ 2.0 y 1.9d (2001~2003)



36/21.0/22.0/1.8' 580g

Juego para reemplazar silent blocks delanteros VAG

907T6

NEW



- Para sustituir el silent blocks del brazo de aluminio del eje delantero de VW Polo (9N).
- La sustitución del silent block se hace de manera segura y fácil directamente en el vehículo.
- Aplicable a: VW - Polo (9N)
SEAT - Ibiza IV, Cordoba (desde. 02) Altea Skoda - Fabia, Roomster
AUDI - A2.



6/18.0/19.0/1.5' 3000g

Juego universal para silent blocks de 26 Pzs.

933T1

NEW



- De uso universal para todo tipo de silent blocks múltiples vehículos.
- 20 casquillos de 10m de espesor y diámetros interiores de: de 34, a 72mm en incrementos de 2mm en 2mm.
- 2 discos de tope para los casquillos.
- 4 husillos de 450mm de: M10, M12, M14, M16;



1/18.0/19.0/1.1' 18270g

■ Extractor para eje motriz delantero

920T1



Permite sacar el rodamiento sin tener que sacar la rótula de la dirección o el montaje de amortiguadores.

- 3 Tornillos M12 x P1.5
- 3 Tornillos M14 x P1.5

2/16.7/17.7/1.1' 8350g

Desmontaje

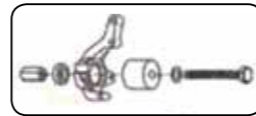

Montaje



■ Extractor para rodamiento de rueda delantera de 4xD

924T1



- 21 Casquillos para rodamientos: 38, 50, 55, 59, 63.5, 66.5, 70.5, 71.5, 73, 73.5, 74.5, 76, 77.5, 81.5, 83.5, 86, 86, 88.5, 91, 102, 102mm
- 1 Tuerca
- 1 Husillo
- 1 Arandela

2/21.5/22.3/1.5' 10.5kg



■ Llave ajustable para tuerca de rodamiento de rueda

908T1



- Se ajusta tanto a tuercas hexagonales como octogonales.
- Incluye 3 juegos de pasadores de bloqueo
- Capacidad:
 - Tuecas Hexagonales de 49 a 135mm
 - Tuecas Octogonales de 49 a 143mm
 - Diámetros de los pasadores: 6mm, 8mm y 10mm.



6/14.8/15.8/1' 2466g

■ Juego de extractores de 2 y 3 patas con maza de impacto

664A

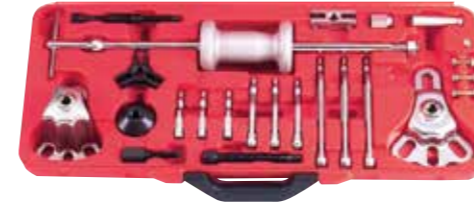

Múltiples usos y combinaciones para diversas tareas de mantenimiento. La maza de impacto permite aplicar mayor fuerza cuando sea necesario.



2/19/20/1.9' 9.5g

■ Separador de rótulas

62802



- Apertua 20mm



20/21/22/1' 1050g

■ Separador de rótulas

62805



- Para la mayoría de turismos y camiones ligeros.
- Apertura: 20mm
- Rango: 20mm-50mm
- Aplicable a: VW-AUDI, BMW, FIAT, FORD, MERCEDES, NISSAN, OPEL, PEUGEOT, RENAULT, ROVER, SAAB, TOYOTA, VOLVO.



20/26.2/27.2/1.1' 1310g

■ Separadores de rótulas universales

**6281522 / 6281532.
6281545**



Ref.	Medida mm	Envase	g
6281522	22	15/10.7/11.7/0.6'	715
6281532	32	10/23.6/24.6/1.4'	2360
6281545	45	10/25.5/26.5/1.4'	2550

■ Extractor hidráulico de rótulas para camión

903T2



- Construido con acero especial endurecido para poder aplicar máxima fuerza en la extracción de rótulas de camión.
- Opera en un espacio mínimo con máxima eficacia.
- Apertura máxima: 70 mm
- Ancho de la boca: 36 mm.
- Husillo hidráulico patentado de 12 Ton.
- Material de fabricación: Acero SCM 440.

2/14.0/15.0/1' 7kg

■ Extractor de rótulas intercambiable

905T8



- Novedoso sistema de cambio rápido.
- Permite seleccionar la boca adecuada sin tener que manipular el extractor completo.
- Ángulo de apertura ajustable.
- Rango de apertura: 20, 22, 24, 27 y 30 mm.
- Longitud del tornillo: 100 mm.
- Longitud del pivote: 125 mm.



3/18.0/19.0/1.0' 6000g

■ Juego de extracción de rótulas

906T3



- Para desmontar rótulas, tirantes o brazos Pitman de la mayoría de vehículos..

3/15.6/16.6/1.25' 5.2kg

■ Extractores de rótulas

628E



Ref.	Apertura	Envase	g
628E23	23mm	30/16.0/17.0/0.99	533
628E29	29mm	20/17.6/18.6/0.9'	880
628E40	40mm	12/18.6/19.6/0.97'	1550



FRENOS
TRANSMISION

■ Separador de rótulas

628300



- Construido con acero templado forjado de una sola pieza.
- Material: SCM440.



Ref.	Apertura	l mm	Envase	g
628300	24mm	300	25/17.0/18.0/0.38'	680

Juego de 5 vasos dentados de 1/2" para ejes MB

905T7

- Vasos dentados para ejes motrices de Mercedes.



REF	Largo	Diente	Uso
905T7-A	70 mm	8 mm	Caja de cambios Mercedes.
905T7-B	70 mm	6 mm	Diferencial Mercedes.
905T7-C	70 mm	6 mm	MB clase G (W460/W461/ W463) Rodamiento de rueda delantera.
905T7-D	70 mm	6 mm	Mercedes W114,W115,W116 Modelos con eje articulado constante.
905T7-E	80 mm	8 mm	Mercedes W116,W123,W126 Eje motriz trasero.

10/17.0/18.0/1.5' 1700g

Vaso dentado de 1/2" para ejes Mercedes (W163/W164)

62820

- Se usa para asegurar el anillo retenedor durante las reparaciones o cambios de rótulas.
- Aplicable a la rótula inferior de los ejes delantero y trasero de MERCEDES-BENZ clase M (W163/ W164).



48/14.0/15.0/0.3' 291g



Juego de extracción de rótulas axiales

904T7

- Permite una rápida y sencilla extracción y sustitución de la rótula de la barra de dirección sin tener que desmontar la cremallera de la dirección.
- Diámetros de las bocas: ø 30-35mm, ø 35- 40mm, ø 40-45mm.



4/20.0/21.0/1.3' 5000g

Extractor de rótulas axiales

9T0801

- Capacidad 33-42mm



36/14.3/15.3/0.8' 397g



Compresores reforzados para muelles de amortiguador

627280

- Capacidad: 23mm ~ 280mm
- Largo: 280mm



6/19.5/21.5/0.5' 3.2kg



Compresor para muelles McPherson

908T5

- Largo máximo: 453mm
- Garra paequeña: 80-115mm
- Garra mediana: 110-150mm
- Garra grande: 140-195mm



13.8kg

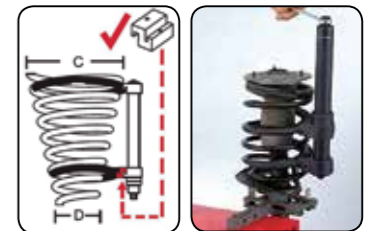

Juego para desmontar torreta de amortiguador de 39p.

939T1

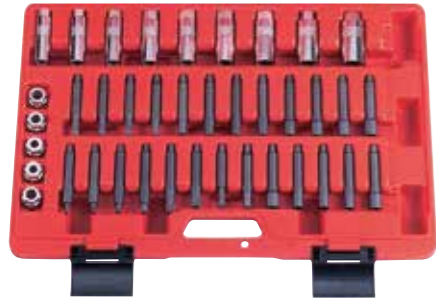

• Contenido:

- Exterior 10.5, 12.5, 14, 14.5 y 14.5mm
- Exterior 14, 16, 17, 18, 19, 21, 22, 24 y 27mm
- Interior 4, 5.2, 6, 6.3, 7, 8, 9, 10 y 12mm
- Interior 5 y 10mm
- Interior 8, 9, 10, y 11mm
- Interior 5, 6, 7, y 8mm
- Interior 3, 3.5 y 4mm
- Interior M12
- Interior T50 y T60

• Aplicable a : VW, AUDI, M-BENZ, AUSTIN MAESTRO, HONDA, NISSAN, SEAT, FIAT, FORD, ROVER, OPEL, PEUGEOT, RENAULT, CITROEN, TOYOTA, CHRYSLER, BMW, VOLVO.

6/22.6/23.6/1.54' 6.25kg



Juego de 9 vasos de impacto de 1/2" para palieres

40912



- 3 Vasos Allen de 1/2" : 14, 17 y 19mm
Allen de 14: VW Passat 1996-2001, Audi A4; delantero y trasero 4x4 Allen de 17: 1998-2005 VW Passat, 1999-2004 Audi A6, 2002-2005 Audi A4; delantero y trasero 4x4 Allen de 19: VW T4,T5,Skoda Fabia.
- 6 Vasos de 12 caras de 1/2": 27, 30, 32, 34, 35 y 36 mm
27mm: Ford Powerstroke; Volvo 480. etc
30mm: BMW E36, E46; Citroen Saxo; Ford Galaxy; Mercedes W123, W124, W126, W129, W201, W203, W211; Opel Astra F, Astra G; Renault Scenic, Clio, Kangoo; Toyota Avensis, Picnic; VW Golf III, Golf IV, Lupo, Touareg, T5 etc.
32mm: Fiat Punto; Ford Escort, Mondeo; Mercedes W140; Nissan Almera; Opel Astra H, Vivaro; Subaru Outback etc.
34mm: GM Motors.
35mm: MADZA.
36mm: Audi; BMW E36, E39, X5; Ford Transit; Seat Ibiza, Cordoba; Nissan Primera; VW Polo, Golf V, Touareg etc.

6/22.6/23.6/1.54' 3767g



Alicate para abrazaderas de palier y transmisión

62526



- Para todo tipo de abrazaderas de oreja
- Aplicable a: AUDI, BMW, CHRYSLER, FORD, GM, HONDA, MAZDA, MERCEDES, NISSAN, OPEL/VAUXHALL, VW etc.
- Diseñado para usar con llave dinamométrica o maneral.



36/20.5/21.5/2.1' 570g

Pistola neumática para purgar frenos

9T3608



Purgado de frenos hidráulicos y embragues mediante fuerza de vacío. La válvula de drenaje se ajusta a la mayoría de los sistemas estándar. Presión de trabajo: 70~170 PSI / 4.9~11.9 BAR. Entrada de aire: 1/4". Consumo de aire: 5.0 CFM. Capacidad del depósito de extracción: 2.0 L. Envase de relleno: 1.0 L.

2/5.0/5.8/2.3' 2.6kg

Barreño de drenaje de aceite

9T3707



Ref.	Volumen	Envase	g
9T3707	16 L	10/9.5/11/5'	950

Barreño de drenaje de aceite

9T3709 / 9T3710



Ref.	Volumen		Envase	g
	L			
9T3709	5		10/6.5/8.5/6.3'	665
9T3710	10		10/10/12/9'	1000

Juego de 3 expansores para tubo de escape

903T3



- Tres tamaños adaptables a todos los automóviles
- Capacidad:

903T3A: 29-44mm
903T3B: 38-62mm
903T3C: 54-87mm

7/20.0/21.0/0.9' 3kg



Vaso para transmisiones automáticas VW

9T0205



- Para la tuerca del eje motriz..
- Aplicable a: VW

20/20.0/21.0/0.44' 1000g

Aspirador de aceite y otros fluidos del automóvil

9T3603



- Capacidad: 12L
- Conectado a un circuito de aire comprimido genera una gran fuerza de aspiración capaz de aspirar todo tipo de aceites, gasolina, diésel, agua, líquido de frenos etc. Con campana transparente para visualizar el flujo de líquido en todo momento.
- Diámetro de los tubos de succión: Ø9mm, Ø7mm, Ø6mm, y tubo para frenos.

1/11.0/12.0/2.5' 11kg

PARTE M

HERRAMIENTAS PARA CAMIÓN



■ Extractor hidráulico de rótulas para camión

903T2



- Construido con acero especial endurecido para poder aplicar máxima fuerza en la extracción de rótulas de camión.
- Opera en un espacio mínimo con máxima eficacia.
- Apertura máxima: 70 mm
- Ancho de la boca: 36 mm.
- Husillo hidráulico patentado de 12 Ton.
- Material de fabricación: Acero SCM 440.

2/14.0/15.0/1' 7kg

■ Alicete para muelles de freno con gancho

9B0103



- Para muelles de frenos de tambor.

12/15.2/16.2/1' 1260g



■ Llave ajustable para tuerca de rodamiento de rueda

908T1

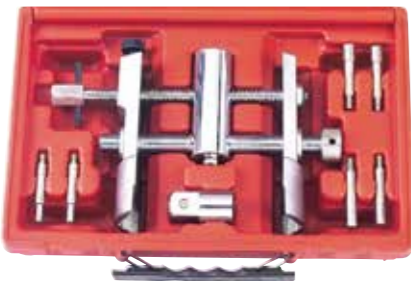

- Se ajusta tanto a tuercas hexagonales como octogonales.
- Incluye 3 juegos de pasadores de bloqueo
- Capacidad:
Tuercas Hexagonales de 49 a 135mm
Tuercas Octogonales de 49 a 143mm
Diámetros de los pasadores: 6mm, 8mm y 10mm.



6/14.8/15.8/1' 2466g

■ Juego de 4 vasos para inyectores diesel

904G3



- 4 vasos de 1/2" para cambiar inyectores diesel.
- Aplicable a: ALFA ROMEO, CHRYSLER, BMW, FORD, VW, MERCEDES, AUDI, OPEL, VAUXHALL, SEAT, VOLVO, ROVER also on VOLVO, MAN2.5TD & SCANIA HGVS.



	Descripción	Largo
22mm	Vaso de 6 caras abierto	110mm
22mm	de 12 caras abierto	75mm
27mm	de 12 caras abierto	78mm
28mm	de 12 caras abierto	78mm

10/11.4/12.4/0.8' 1.14Kg

■ Extractor de inyectores diésel

9G0114



Para extractores diésel BOSCH y LUCAS.
Con adaptadores M8, M12 y M14
Aplicable a: VOLVO, SCANIA.



40/16.0/18.0/1.8' 400g

■ Lapeador para asientos de inyectores diésel

907G7



Diseñado para limpiar y escariar asientos de inyectores common rail.
Fresa recta de 15mm de uso universal.
Fresa recta de 17mm para inyectores DELPHI / BOSCH (BMW / PSA / RENAULT / FORD).
Fresa recta de 19mm para inyectores BOSCH (MERCEDES CRD)
Fresa oblicua de 19mm para FIAT / IVECO.
Mango T y guía.

20/19.2/19.7/2' 950g

Limpiador y comprobador de inyectores diésel

905G13



- Para todos los motores de turismo o camión.
- Para comprobar la presión de salida, el patron de atomizado etc.
- Manómetro de 70mm.
- Bomba: 11mm.
- Carrera: 20mm.
- Volumen de descarga: 2.0 cc.
- Peso: 8 kg.
- Fácil de usar.
- Acorde al estándar internacional.
- Capacidad del manómetro : 9000 PSI (640 kg/cm2)
- Adaptadores: M-12 x P1.5, M-14 x P1.5, M-16 x P1.5

2/15.7/16.7/1.27' 7850g

Llave de 3 patas para filtros de aceite

9B0704



- Cuadradillo de 1/2".
- Para filtros de 95 a 165 mm.

10/14.0/15.0/0.81' 1.4Kg



Compresímetro para vehículos industriales y agrícolas diésel

916G2



Manómetro de 63mm relleno de glicerina con latiguillo reforzado hasta 4,500 psi.
Escala doble 0-1,000 psip y 0-70 bar.
13 adaptadores (Deere, BMW etc)

3/15.9/16.9/1.5' 5300g

Mordaza grip para filtros de aceite

639230



Ref.	Diámetros mm	Envase	<i>l</i> mm	 g
639230	53-118mm	40/19.5/20.5/1.7'	230	480

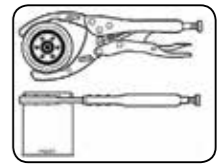

Alicate para anillos de pistón

62302



- Elimina el riesgo de rotura o deformación .
- Capacidad: 110mm-160mm.



50/18.5/19.5/3' 420g

FORCE

PARTE N

HERRAMIENTAS PARA CARROCERÍA



■ Juego para desabollar de 11 Pzs.

665B



Contenido:

- 1 Tubo de diámetro 22.5mm x 590mm
- 1 Tubo de diámetro 22.5mm x 200mm
- 1 Tubo con dos agujeros de diámetro 29mm x 40mm
- 1 Maza de impacto de 4.5 Kgs.
- 1 Placa de 6mm x 170mm / 1 Placa de 6mm x 120mm
- 1 Placa de 6mm x 120mm / 1 Placa de 6mm x 200mm)
- 1 Placa de 3mm x 100mm
- 1 Cadena con gancho
- 1 Tuerca hexagonal de 29mm

2/16.8/17.8/1.1' 8420g

■ Ventosa neumática para desabollar

905M4

NEW

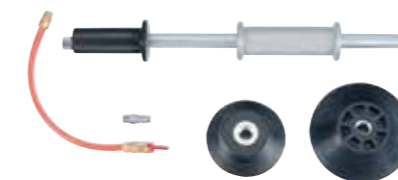

- Con ventosas de goma de 120mm y 150mm
- Maza de impacto de 1.4 Kgs.
- Manguera de 325mm
- Válvula de entrada de aire en la empuñadura
- Conexión de aire de 1/4"



4/17.0/18.0/3.3' 3.8kg

■ Juego de chapista de 7 Pzs.

50713B



Contenido:

- 62602 Martillo de acabado
- 62603 Martillo convexo
- 62604 Martillo de chapista estándar
- 68301 Tas de chapista de uso general
- 68302 Tas de chapista curvo
- 68303 Tas de chapista de tacón
- 68304 Tas de chapista de puntera

3/22.0/23.0/1.51' 7300g

Juego de chapista de 7 pzs. de goma

50720



Contenido:

- 1- Tas de goma de tacón pequeño
- 1- Tas de goma de tacón grande
- 1- Tas de goma de doble yunque
- 1- Tas de goma de uso general
- 1- Tas de goma de cuña
- 1- Tas de goma de puntera
- 1- Tas de goma de cuchara



2/22.0/23.0/1.5' 11kg

Martillo de chapista

62601



40/20.3/21.3/2.6' 510g

Tas de chapista de cuchara

68351



- Largo: 510 mm
- Ancho: 59mm
- Material: 1055 acero al carbono
- Acabado en pulido espejo

8/19.4/20.4/1.2' 2425g

Tas de chapista de cuchara

68352



- Largo: 401 mm
- Ancho: 58mm
- Material: 1055 acero al carbono

8/14.3/15.3/1.2' 1787g

Tas de chapista de paleta

68354



- Largo: 250 mm
- Ancho: 50.8 X 109mm
- Material: 1055 acero al carbono

50/18.9/19.9/0.52' 378g

Tas de chapista de cuchara corto

68355



- Largo: 286 mm
- Ancho: 51mm
- Material: 1055 acero al carbono

20/17.0/18.0/0.45' 850g

Tas de puntera reticulado

68305



- Largo: 122mm
- Ancho: 59mm
- Alto: 29mm
- Material: 1055 acero al carbono

20/27.7/28.7/0.46' 1385g

Tas de chapista de uso general

68306



- Largo: 66mm
- Ancho: 61mm
- Alto: 74mm
- Material: 1055 acero al carbono

20/23.5/24.5/0.5' 1175g

Mordaza grip de soldar

66201



- Tamaño: 225mm
- Garras de Cr-Mo
- Niquelada
- Para fijar piezas que van a ser soldadas



40/24.8/25.8/1.4' 620g

Pistola neumática para quitar puntos de soldadura

910M5

NEW



- Idónea para eliminar puntos de soldadura en la carrocería.
- Fuerza de taladrado multiplicada 3 a 1 mediante 2 engranajes planetarios para poder perforar acero especial BTR, BOR, USIBOR.
 - Completamente ajustable.
 - Contenido :
 - 1 Taladro neumático para soldaduras con broca de 8mm.
 - 5 brocas HSS-Co , 3 de 8 mm y 2 de 6.5 mm.
 - 1 Llave allen de 3mm
 - 1 Frasco de aceite.
 - 1 Regulador de aire.
 - 1 Conexión de 1/4".

6/15.7/16.7/1.54' 2617g

Mordaza de tiro

62501

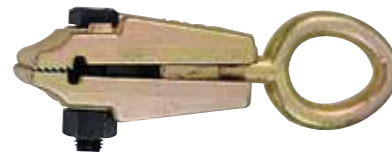

- Para tiro recto
- Capacidad: 5 tons



10/19.4/20.4/0.6' 1940g

Modaza de tiro bidireccional

62502



- Para dos sentidos de tiro
- Capacidad en 2 sentidos: 2 tons
- Capacidad de tiro longitudinal: 5 tons

10/21.0/22.0/0.6' 2100g

Mordaza de tiro

62504



- Para tiro longitudinal
- Apropriada para espacios reducidos
- Capacidad: 3 ton

10/20.1/21.1/0.88' 2kg

Modaza de tiro bidireccional

62505

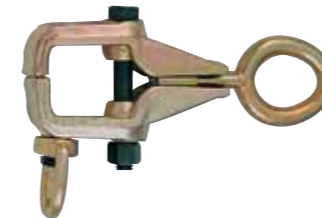

- Para dos sentidos de tiro
Capacidad en 2 sentidos: 2 tons
Capacidad de tiro longitudinal: 3 tons
- Apropriada para espacios reducidos

10/20.1/21.1/0.94' 2kg

Mordaza de tiro

62506

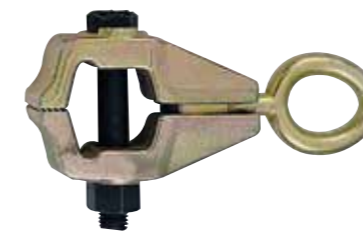

- Para tiro longitudinal
- Capacidad 5 ton

6/13.4/14.4/0.71' 2230g

Mordaza de tiro de tijera

62510



- Para tiro longitudinal
- Sin necesidad de atornillar.
- A medida que se tira se aprieta más.
- Capacidad: 3 ton

6/15.0/16.0/0.71' 2500g

Lijadora orbital 3 en 1 de alto rendimiento

82603



- Diámetro de lija de 152 mm
- 10000 R.P.M
- Opción de orbitación de 5 mm
- Longitud : 225 mm
- Entrada de aire :1/4".
- Manguera de aire:3/8.
- Consumo de aire: 368 L/min
- Peso: 0.82

12/9.0/13.0/2.5' 815g

Escofina de carrocerero

65701



Aplicación: Para lamas de 350mm.

20/15.7/16.7/2.1' 785g

Lamas para escofina de carrocerero

6571409 / 6571412



Ref.	Dientes/Pulgada	l mm	Envase	g
6571409	9	350	60/18.6/19.6/0.5'	310
6571412	12	350	60/21/22/0.5'	350

Juego de 4 espátulas de chapista

904M7

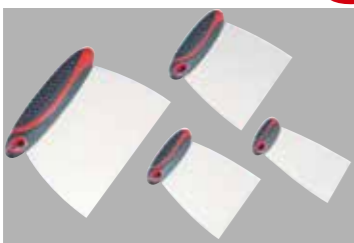

NEW

- Construidas con acero especial flexible
- Empuñaduras bicomponente ergonómicas
- Perfectas para aplicar masillas de relleno en carrocería
- Incluye hojas de : 50, 75, 100 y 150mm.

40/9.0/10.0/2.8' 240g

Juego de 5 palancas de chapista

T905M2



Contenido:

- 905M2P1 1-Palanca para sacar embellecedores grande
- 905M2P2 1-Palanca para sacar embellecedores pequeña
- 905M2P3 1-Rascador de juntas
- 905M2P4 1-Separador de manguera de radiador
- 905M2P5 1-Extractor de chavetas

6/5.0/6.0/0.65' 833g

Juego de cuatro espátulas de plástico

904M6



- Ideales para quitar embellecedores e insignias de la carrocería
- También son muy útiles para limpiar llantas de aleación.
- Los bordes son de polipropileno para no marcar o rayar la pintura o los acabados interiores. También se pueden afilar.
- Largo: 270mm
- Hojas de: 19mm, 22mm, 25mm y 38mm

20/10.0/11.0/3.6' 500g



Juego para desmontar puertas de automóvil

904M1



Este práctico kit incluye una manilla para puerta, dos separadores de paneles de puerta y un extractor para embellecedores GM.

24/13.4/14.9/2.7' 560g



Juego de 5 sacagrapas de nylon

905M1



- Para desmontar inserciones plásticas en el habitáculo
- Se insertan las palancas entre la pieza a extraer y la tapicería y se hace palanca.



48/19.3/20.3/3' 400g

Alicate separador

9M0101



Para sacar forros interiores y otros elementos decorativos sujetos con remaches de plástico.



72/17.3/18.3/3.8' 240g

Juego para lunas de 44 Pzs.

944M1



- 1 Herramienta de perforar
- 1 Rollo de alambre cuadrado
- 1 Alambre de corte
- 1 Alambre de corte dorado
- 2 Asas para el alambre
- 2 Extractores de molduras de ventana
- 2 Ventosas articuladas dobles de 120mm
- 1 Rascador de cordones de soldadura
- 1 Piedra de afilar
- 1 Cuchillo de 450mm para cortar uretano



2/12.0/13.0/3' 6kg

Juego para lunas de 13 Pzs.

K913M1



Contenido:

- 9M0503 Alambre para lunas cuadrado de acero inoxidable
- 9M2901 Guía para alambre
- 902M2 2 Asas para el alambre
- 9M2902 Iniciador para el alambre
- 9M2903 Perforador para el alambre
- 5055P401 Cutter
- 5055P401-P 5pc hojas de repuesto para cutter 5055P401
- 9U2102 Rascador de 12mm con mango bicomponente
- 9U2102-12 5 Cuchillas de 12mm
- 9U2102-16 5 Cuchillas de 16mm
- 9U2102-16A 5 Cuchillas biseladas de 16mm
- 9U2102-20 5 Cuchillas

6/12.2/13.2/1.5' 2035g

Ventosas de aluminio multiusos

634..A



- Para succionar abollones.
- Para reparar ventanillas.
- Para montar o desmontar la lunas delantera o trasera.

Ref.	Descripción	Envase	Capacidad Kgs	g
63401A	Ventosa simple	20/10.9/11.9/1.6'	30	480
63403A	Fija 2 ventosas	20/20.1/21.1/4'	50	780
63404A	Flexible 2 ventosas	20/24.4/25.4/4'	35	1180
NEW 63405A	Fija 3 ventosas	10/14.1/15.1/3.1'	100	1410

PARTE O

HERRAMIENTAS PARA MOTOCICLETA



Caballete sujetalunas plegable

9M3401



- Plegable para ahorrar espacio.
- Tamaño: 600mm



 1/9.0/10.0/1.3'  9kg



Juego de extracción de limpiaparabrisas

905M5



- Uso universal
- Incluye 4 extractores ajustables y un puente de tracción. Es válido para casi todos los limpiaparabrisas.





 10/11.7/12.7/1.27'  1170g

Pistola para resina epoxy bicomponente

9M3301



- Especialmente indicado para aplicar resina epoxy de parabrisas

 25/10.8/11.8/2.8'  433g



Kit para extracción de plato magnético de moto

909Y1



Adaptadores:

85mm: M14xP1.5, M16xP1.5 y M18xP1.5

65mm: M19xP1.0, M28xP1.5, M20xP1.0 / M27xP1.25; M22xP1.0 / M25xP1.5; M22xP1.5 / M26xP1.5; M24xP1.0 / M27xP1.0L; M26xP1.0 / M28xP1.0

Aplicables a:

YAMAHA, SUZUKI, HONDA, BOSCH, DUCAN, GLERA, SAM, CAGIVA, SFERA, KYMCO, MBK, PEUGEOT, KIMOO, MOTOPLATT, KAWASAKI, KOKUSAN, MINARELLI, DUCATI.



10/17.8/18.8/1.15' 1780g

Útil para instalar el sellador de la horquilla

903Y1



- De uso prácticamente universal.
- Tanto para horquillas convencionales como invertidas.
- Aplicable a diámetros desde 26 a 45mm.



20/22.0/23.0/0.7' 2200g

Llave para tapa de horquilla (46x50)

9Y0121



- Para sacar la tapa de la horquilla en RM y CR.
- También sirve para sacar el tope de compresión en los últimos modelos de RM.
- Sustituye a la referencia 09941-53630 de Suzuki.
- Bocas octogonales de 46mm y 50mm
- También sirve para la Honda CRF250R de 2010.



48/16/17/0.74' 334g

Destornillador angular para carburadores

910Y1



- Diseñado para ajustar carburadores de motocicleta con tornillos de difícil acceso. Cada vuelta de la empuñadura da una vuelta a la punta de atornillar.
- Posicionable en recto o a 90°.
 - Equipado con puntas surtidas.

12/11.0/12.0/2.1' 916g

Kit de sincronización de carburadores

919G2



Manómetro: 0~15 PSI:0~1 kg/cm²
Vacío: 0~28 in-Hg (0~70 cm-Hg)

Contenido:

- 4 Relojes de sincronización de 88mm en soporte metálico.
- 4 Mangueras de 8 X 5 X 750mm
- 4 Tubos de extensión de 3.9X52mm
- 4 Tubos de extensión de 3.9X122mm
- 8 Conectores cónicos de 8 X 40mm
- 4 Adaptadores de 10 X 53mm (M6 X 0.75)
- 4 Adaptadores 10 X 60mm (M6 X 1.0)



6/20.0/21.0/2.25' 3330g

Cepillo para cadenas de transmisión

9Y0133



- Con posición angular y diversos cepillos adaptable para los distintos tamaños de cadena.
- Para todas las cadenas.



72/8.5/10.0/3.6' 118g

Compresor de válvulas

62110



- Esta herramienta está diseñada para comprimir los muelles de las válvulas tras desmontar la chaveta.
- Contenido:
3 Adaptadores: 16, 19,; 23, 25 y 30mm.
3 Tornillos de presión: 70mm, 110mmL, 120mm.
1 Gato forma "C" para presionar.



10/21.5/22.5/2.2' 2150g

Ceñidor de segmentos para moto

6202080



- Mecanismo de carraca.
- Capacidad: 40 - 80 mm.

50/7.0/8.0/0.89' 140g

Llave para filtro de aceite

9B0701



- Se ajusta automáticamente sin deslizarse.
- Cuadrado de 3/8".
- Para filtros de 60mm a 80mm.



48/18.1/19.1/1.7' 380g

Punta para ejes de motocicleta

9T1403



- 24mm para SUZUKI / HONDA
- 22mm para KAWASAKI
- 19mm para YAMAHA



100/13.6/14.6/1.5' 136g

PARTE P

EXTRACTORES



■ Extractor de guillotina

66602



Contenido:

- 1 Husillo central
- 1 Separador de rodamientos de guillotina de 75-105mm
- 2 Husillos laterales (8"x1.75p)
- 2 Extensiones para los husillos laterales (8"x1.75p)
- 1 Puente de tracción
- 1 Tuerca

2/17.3/18.3/1'

8650g

■ Juego de 2 extractores de guillotina

66610



- Juego de 2 extractores de guillotina (SCM415 acero forjado HRC 42-45) Capacidad: 30-50mm y 50-75mm

- 4 Extensiones para el extractor mayor: Hex 17mm x 127mm x 3/8" - 16T
- 4 Extensiones para el extractor menor: Hex 14mm x 102mm x 3/8" - 16T
- 1 Puente de tracción (S45C)
- 1 Husillo central $\Phi 9/16"$ - 10T x 175mm S45C



5/23.0/24.0/1.8'

4.6kg

■ Extractor de guillotina

66612



- 1 Separador de rodamientos de guillotina SCM415 acero forjado HRC 42-45 Capacidad: 75-105mm
- 2 Husillos laterales Hex 19mm x 200mm x $\Phi 15.24$ mm - 1.75P)
- 2 Extensiones Hex 19mm x 200mm x $\Phi 15.24$ mm - 1.75P)
- 1 Puente de tracción S45C
- 1 Husillo central $\Phi 18.65$ - 10T x 292mm S45C
- 1 Tuerca central



2/18.0/19.0/0.5'

9kg

■ Extractor de guillotina hidráulico

66613



- 1 Husillo hidráulico SCM420 $\Phi 37.7$ mm
- 1 Separador de rodamientos de guillotina SCM415 Drop forged HRC 42-45 Capacidad: 105-150mm
- 2 Husillos laterales Hex 21mm x 250mm x $\Phi 5/8"$ - 11 NC)
- 2 Extensiones Hex 21mm x 250mm x $\Phi 5/8"$ - 11 NC)
- 1 Puente de tracción
- 1 Adaptador



2/24.0/25.0/0.8'

12kg

■ Extractor de guillotina

666150



Ref.	Capacidad	Husillo	Agujeros
666150	105-150mm	19x260mm	2 x 3/8" x 16 Ton.

■ Juego de extractores de garras

664P



Con múltiples posibilidades de combinación en 2 y 3 garras interior o exterior. Ideal para todo tipo reparaciones

Contenido:

- 9 Garras reversibles ajustables
- 1 Husillo central
- 1 Puente para 2 garras
- 1 Puente para 3 garras
- 1 Tuerca reversible y ajustable
- 3 Tornillos con tuerca



6/13.6/14.6/1.33'

2260g

■ Juego de extractores interiores y exteriores

66431

- Acero Cr-V forjado

Contenido:

- Extractor interior pequeño capacidad: 15-30mm
- Extractor interior pequeño capacidad: 30-80mm
- Extractor exterior capacidad: 15-80mm

3/16.0/17.0/1.5'  5300g



■ Juego de extractores interiores frontales de rodamientos

905T6

- Una maza de impacto y cuatro extractores.
- Los cuatro extractores son regulables y se instalan en el interior del rodamiento.
- Capacidades: 1/2" (10-14mm), 5/8" (15-19mm), 13/16" (20-24mm), 1-1/8" (25-32mm)

5/17.5/18.5/1.25'  3650g



■ Juego de extractores interiores frontales de rodamientos

910T1

- Extractores con capacidad de 8 a 32mm.
- Maza de impacto

5/16.5/17.5/1.66'  3500g



■ Extractor interior de rodamientos de 3 garras

66620

- Diámetro interior de 12 a 38mm

4/12.4/13.4/1.17'  3050g



■ Extractor de rodamientos

66618

- Este juego es especialmente útil cuando el rodamiento es inaccesible por el exterior y también por el interior. Las garras se insertan entre las dos pistas del rodamiento tirando de la pista exterior.
- Rango de ajuste: 20 a 95 mm
- Aplicable a rodamientos:
6004 ~ 6010 Garra de : Ø 6 / 8
6201 ~ 6206 Garra de : Ø 5.5 / 6 / 8
6300 ~ 6304 Garra de : Ø 6 / 8

20/17.0/18.0/1.5'  800g



■ Extractor de rodamientos

66618M

- Este juego es especialmente útil cuando el rodamiento es inaccesible por el exterior y también por el interior. Las garras se insertan entre las dos pistas del rodamiento tirando de la pista exterior.
- Rango de ajuste: 35 ~ 120 mm
- Aplicable a rodamientos:
6207 ~ 6211 Garra de : Ø 11 / 12.5 / 15
6305 ~ 6308 Garra de : Ø 11 / 12.5
6403 ~ 6405 Garra de : Ø 11 / 12.5 / 15

12/22.0/23.0/1.3'  1700g



■ **Juego de extractores de 2 garras multiusos de 21 pzs.**

666A03



- Para gran variedad de aplicaciones. Rodamientos, alternadores, generadores, poleas de distribución, cigüeñales, direcciones hidráulicas etc.
- Ancho de apertura : 60 a 85mm y 88 a 138mm
- Alto: 41mm y 44mm

5/20.6/21.6/1.3'  4120g

■ **Juego de extractores universal**

66626



- 1 Puente para 2 garras
- 1 Puente para 3 garras
- 9 Garras de 100 / 200 / 250 mm
- 2 Husillos

3/20.5/21.3/1.2'  7200g

■ **Extractor de 2 garras**

65901



Ref.	Medida	Capacidad	Apertura mm
6590103	75mm	2 tons	40/75
6590104	100mm	4 tons	50/100
6590106	150mm	6 tons	70/150



■ **Extractor de 3 garras**

65902



Ref.	Medida	Capacidad	Apertura mm
6590203	75mm	2 tons	40/75
6590204	100mm	4 tons	50/100
6590206	150mm	6 tons	70/150



■ **Extractores de 2 garras deslizantes**

65909...



Ref.	Ancho	<i>l</i>		
		Largo	Ton	
65909090	90	100	3	1.1
65909130	130	100	3	1.3
65909160	160	150	5	3.2
65909200	200	150	5	3.6
65909250	250	200	7.5	7.8
65909350	350	200	7.5	9.2

INDICE POR REFERENCIAS



Ref.	Página	Página
1013R-562	A-15	
102101R	A-01	
102105R	A-01	
10217R	A-02	
10217R-188E	A-02	
10217R-286	A-05	
10225R	A-35	
10318R	A-10	
10318R-509	A-10	
121D12	D-02	
121D34	D-02	
122D12	D-02	
122D34	D-02	
123D0304	D-02	
123D05507	D-02	
124D0304	D-02	
124D0506	D-02	
126D0810	D-02	
126D1520	D-02	
126D2527	D-02	
126D3040	D-02	
151302	E-03	
151303	E-03	
151304	E-03	
152302	E-03	
152303	E-03	
152304	E-03	
1533007	E-04	
1533008	E-04	
1533010	E-04	
1533012	E-04	
1543004	E-04	
1543005	E-04	
1543006	E-04	
1543007	E-04	
1543008	E-04	
1543010	E-04	
1543012	E-04	
1543014	E-04	
1563025	E-04	
1563030	E-04	
1563040	E-04	
1563045	E-04	
1563050	E-04	
1743004	F-18	
1743005	F-18	
1743006	F-18	
1743007	F-18	
1743008	F-18	
1743010	F-18	
1743012	F-18	
1743014	F-18	
1747504	F-18	
1747505	F-18	
1747506	F-18	
1747507	F-18	
1747508	F-18	
1747510	F-18	
1747512	F-18	
1763010	F-18	
1763015	F-18	
1763020	F-18	

Ref.	Página	Página
1763025	F-18	
1763027	F-18	
1763030	F-18	
1763040	F-18	
1763045	F-18	
1763050	F-18	
1763055	F-18	
1763060	F-18	
1767510	F-18	
1767515	F-18	
1767520	F-18	
1767525	F-18	
1767527	F-18	
1767530	F-18	
1767540	F-18	
1767545	F-18	
1767550	F-18	
1767555	F-18	
1767560	F-18	
1783005	F-18	
1783006	F-18	
1783008	F-18	
1783010	F-18	
1783012	F-18	
1787505	F-18	
1787506	F-18	
1787508	F-18	
1787510	F-18	
1787512	F-18	
1793004	F-19	
1793005	F-19	
1793006	F-19	
1793007	F-19	
1793008	F-19	
1793009	F-19	
1793010	F-19	
1793012	F-19	
1793013	F-19	
1793014	F-19	
1797504	F-19	
1797505	F-19	
1797506	F-19	
1797507	F-19	
1797508	F-19	
1797509	F-19	
1797510	F-19	
1797512	F-19	
1797513	F-19	
1797514	F-19	
2044	C-01	
2061	C-01	
20611	C-02	
2062	D-02	
2068	C-02	
20712	C-04	
20719	C-01	
2081C	D-01	
2084	C-02	
2085	C-02	
2086	C-01	
2087	C-03	
2088	C-03	

Ref.	Página	Página
2095	C-05	
2097	C-04	
2106A	C-03	
2108	C-03	
2119T	C-01	
2125	C-04	
2133	D-03	
2134	C-04	
2138Q	D-03	
2141	C-05	
2142	C-03	
2144Q	D-03	
2203-72-5	D-03	
2203-72-9	D-03	
2203S-72-9	D-04	
2253-72	D-04	
2253-72-9	D-04	
2253S-72-9	D-04	
2262	A-03	
2263	D-01	
2281-72	D-05	
2281-72-5	D-05	
2281S-72	D-05	
2292-9	D-05	
2312-72	D-06	
2312-72-5	D-06	
2313	D-01	
2315	D-01	
2421	D-07	
2421-9	D-07	
2421F	D-08	
2421S-9	D-08	
24606020	I-07	
24606025	I-07	
24606027	I-07	
24606030	I-07	
24606040	I-07	
24606045	I-07	
24606050	I-07	
24606055	I-07	
24606060	I-07	
24606070	I-07	
2461-5	D-09	
24807814	I-07	
24807816	I-07	
24807818	I-07	
3078	E-01	
3095	E-01	
3212	E-01	
3212-9	E-01	
3213	E-03	
321321	D-09	
321322	D-09	
321323	D-09	
322321	D-09	
322322	D-09	
322323	D-09	
3232	E-02	
3232-9	E-02	
3243203	D-09	
3243204	D-09	
3243205	D-09	



Ref.	Página	Página
9G0208	J-35	
9G0303	J-38	
9G0603	J-27	
9G0606	J-24	
9G0609	J-34	
9G0612	J-70	
9G0616	J-27	
9G0704	J-28	
9G0708	J-28	
9G0709	J-28	
9G0712	J-27	
9G0713	J-66	
9G0716	J-66	
9G0802	J-32	
9G0803	J-32	
9G0804	J-33	
9G0901	J-56	
9G0902	J-56	
9G1001	J-49	
9G1002	J-50	
9G1206	J-22	
9G1207	J-12	
9G1211	J-10	
9G1501	J-49	
9G1701	J-11	
9G1801	J-54	
9G1801A	J-54	
9G1802	J-54	
9G1802A	J-54	
9G1803	J-65	
9G1804	J-65	
9G1805	J-66	
9G1806	J-66	
9G2204	J-39	
9G2401	J-04	
9G3101	J-02	
9G3102	J-02	
9G4001	J-38	
9G4005	K-03	
9G4301	J-68	
9M0101	N-08	
9M3301	N-10	
9M3401	N-10	
9T0101	B-11	
9T0104	B-11	
9T0202	L-03	
9T0205	L-18	
9T0801	L-15	
9T1403	O-03	
9T3603	L-18	
9T3608	L-17	
9T3707	L-17	
9T3709	L-18	
9T3710	L-18	
9U0202	B-21	
9U0203	B-21	
9U0311	B-25	
9U0401	B-22	
9U050112	B-12	
9U050114	B-12	
9U050118	B-12	
9U050124	B-12	

Ref.	Página	Página
9U050130	B-12	
9U050136	B-12	
9U050142	B-12	
9U0706	J-62	
9U1101	B-21	
9U1102	B-21	
9U3002	K-03	
9U3201	L-08	
9U3202	L-08	
9Y0121	O-01	
9Y0133	O-02	
K2047	D-12	
K2139	I-01	
K2463	D-02	
K3021	J-01	
K3133	I-02	
K4032	I-03	
K4044	F-22	
K4079	I-03	
K4087	F-01	
K50411	C-09	
K50625	C-09	
K5081-20	C-14	
K5084	C-09	
K5086	C-11	
K50916S	C-06	
K50920	C-16	
K51017	C-14	
K51018	C-11	
K51019	C-10	
K51113	C-15	
K51210F	C-13	
K5121-24	C-11	
K51213-26	C-14	
K51216	C-13	
K5121S	C-12	
K51225	C-14	
K51227	C-16	
K5128-26	C-10	
K5183	B-02	
K64706	B-17	
K913M1	N-09	
T51226	C-09	
T905M2	N-07	